

305 R A M A C.®

Random Access Method
of Accounting and Control

305 RAMAC

Random Access Method
of Accounting and Control

Manual of Operation

MAJOR REVISION (April 1957)

This edition, Form 22-6264-1, obsoletes Form 22-6264-0 and all earlier editions.
Major changes are:

<u>PAGE</u>	<u>SUBJECT</u>
30	Field Compare
45	Programmed Division
74	380 Console
89	380 Console Typewriter
102	370 Printer
126	323 Card Punch
133	Error Correction Procedures (323)

CONTENTS

IN-LINE PROCESSING	5
INTRODUCTION	5
IBM Punched Card Approach	6
IBM 305 RAMAC Approach	8
System Organization	10
PROGRAMMING	15
Loading the Program	24
Loading the Disk Storage	33
Unloading the Disk Storage	36
Arithmetic Operations	37
Availability Editing	40
Other Logic Elements	47
A SAMPLE PROGRAM	50
DISK STORAGE ORGANIZATION	61
INTERNAL CHECKING	70
380 CONSOLE	74
EXAMPLES OF CONSOLE OPERATION	85
Start - Stop Procedures	85
Inquiries	85
Error Correction	85
Alterations to Drum Tracks	87
Testing Procedures	88
380 CONSOLE TYPEWRITER	89
Typewriter Control Panel	90
370 PRINTER	102
Operating Keys and Lights	104
Printer Control Panel	105
Tape-Controlled Carriage	113
Operating Features	116
Form Control	117
Multiple Line Printing	121
Timing Charts	124
323 CARD PUNCH	126
Feed and Punch Unit	127
Operating Keys and Lights	127
323 Control Panel	128
Error-Correction Procedures	133
CONTROL PANEL SUMMARY	137
CODING	147
INDEX	149

RAMAC is a generic term that has been coined to mean Random Access Method of Accounting and Control. The IBM 305 is the first of a series of machines designed to approach in-line accounting on a mechanized basis. This approach requires the use of a storage device that permits rapid access to any of several million characters of data comprising the accounting records.

IBM 305 RAMAC

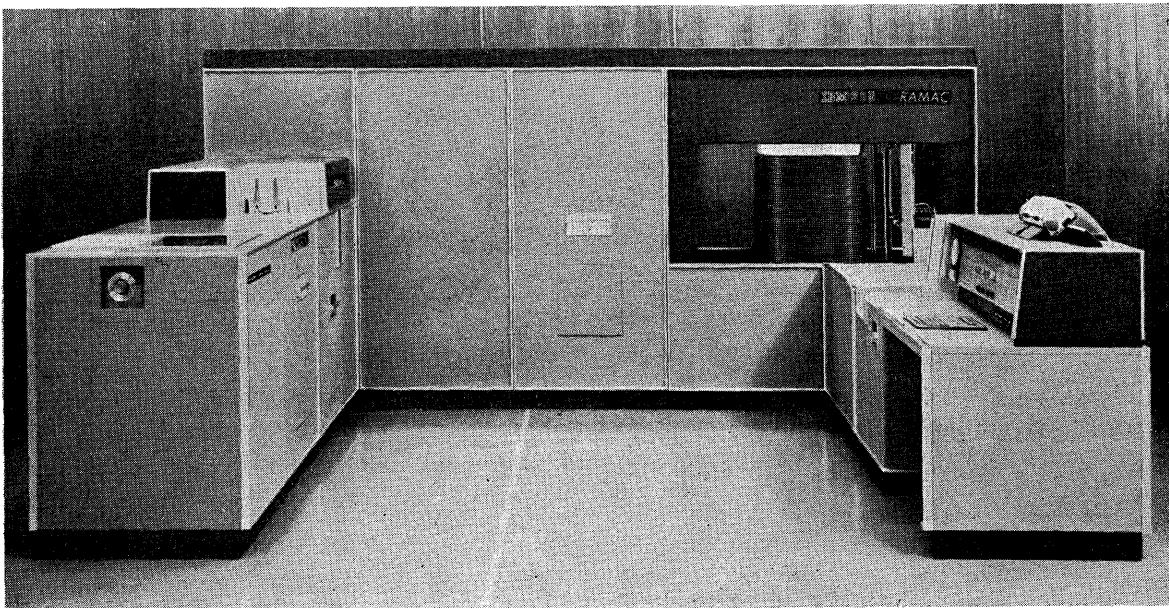

IN-LINE PROCESSING

BEFORE the development of mechanized accounting, business records were maintained in a series of ledgers by clerks who posted each transaction to the proper accounts. For example, if a manufacturing company bought raw material, the clerk subtracted the cost of the material from the cash account and added the cost to the raw material account. This system of accounting was slow, and subject to clerical errors, but it had the inherent advantage that the accounts were constantly maintained in balance.

An important feature of this system of bookkeeping is that the clerk had access to all the accounts in random order. In the example just mentioned, the clerk changed the balances in the cash account and the

raw material account. The next transaction could reflect the fact that some of the raw material had entered the manufacturing process, in which case the clerk would subtract this amount from the raw material account and add it to the material-in-process account. However, it is more probable that the next transaction would affect entirely different accounts. Perhaps some of the finished products were sent to the wholesaler. This transaction would affect the inventory and accounts receivable balances. Because the clerk has direct access to all of these accounts, he can complete the posting of each transaction before beginning the posting of the next. This accounting method is called *in-line processing*. In-line processing has previously not been practical in automatic accounting systems because of the difficulty of reaching and changing single records in large files.

IBM 305 RAMAC

Random Access Method of Accounting and Control

THE IBM RAMAC is built around a random-access memory device that permits the storage of five million characters of business facts in the machine. In effect, the machine stores the equivalent of 62,500 80-column IBM cards. Actually, the storage is organized into 50,000 100-character records which are used to store master information, and previous balances. For processing, the machine can obtain any of these 50,000 records without scanning through the intervening records.

These master and balance records may be considered roughly analogous to the ledgers used in the

manual systems of accounting. Each record may contain the equivalent of the last entry to an open-item account. In general, the records should be thought of as the master files used in punched-card accounting. Repetitive information and balances are stored in the memory. The detail information is usually maintained on IBM cards. The machine performs all bookkeeping functions in posting transactions to the proper accounts. This facility, and the ability to reach any of the records directly, permits the machine to perform in-line processing. The huge storage afforded by the random-access memory allows the machine to do a full-spread distribution type of accounting.

IBM Punched-Card Approach

FIGURE 1 shows a simplified flow-chart for the offset card order method of inventory control and invoicing, using conventional punched-card equipment. The orders, receipts and other transactions that will change the inventory are punched into IBM cards and verified. All orders are given a manual credit check. The stock editor determines whether an order can be filled, and files the transaction cards behind the corresponding balance cards in an oversize card tray, with the balance card and the transaction cards offset from the body of the file. At the end of the filing operation, the offset cards are manually removed from the file and run through an accounting machine that produces a transaction register and summary punches a new inventory balance card. The revised inventory

card is interpreted and refiled in the inventory balance file.

The order cards and returns cards are sorted out and run through a calculator to obtain extensions. The calculated cards are hand assembled with heading cards and run through the accounting machine to produce the invoice and other shipping documents. Simultaneously, accounts receivable cards are punched which are later used for billing. The source cards are sorted; the heading cards are returned to the file while the order cards enter the material accounting procedure.

This method of inventory control has been extremely successful. However, a considerable amount of manual editing and filing is required, and cards must be processed through seven different machines.

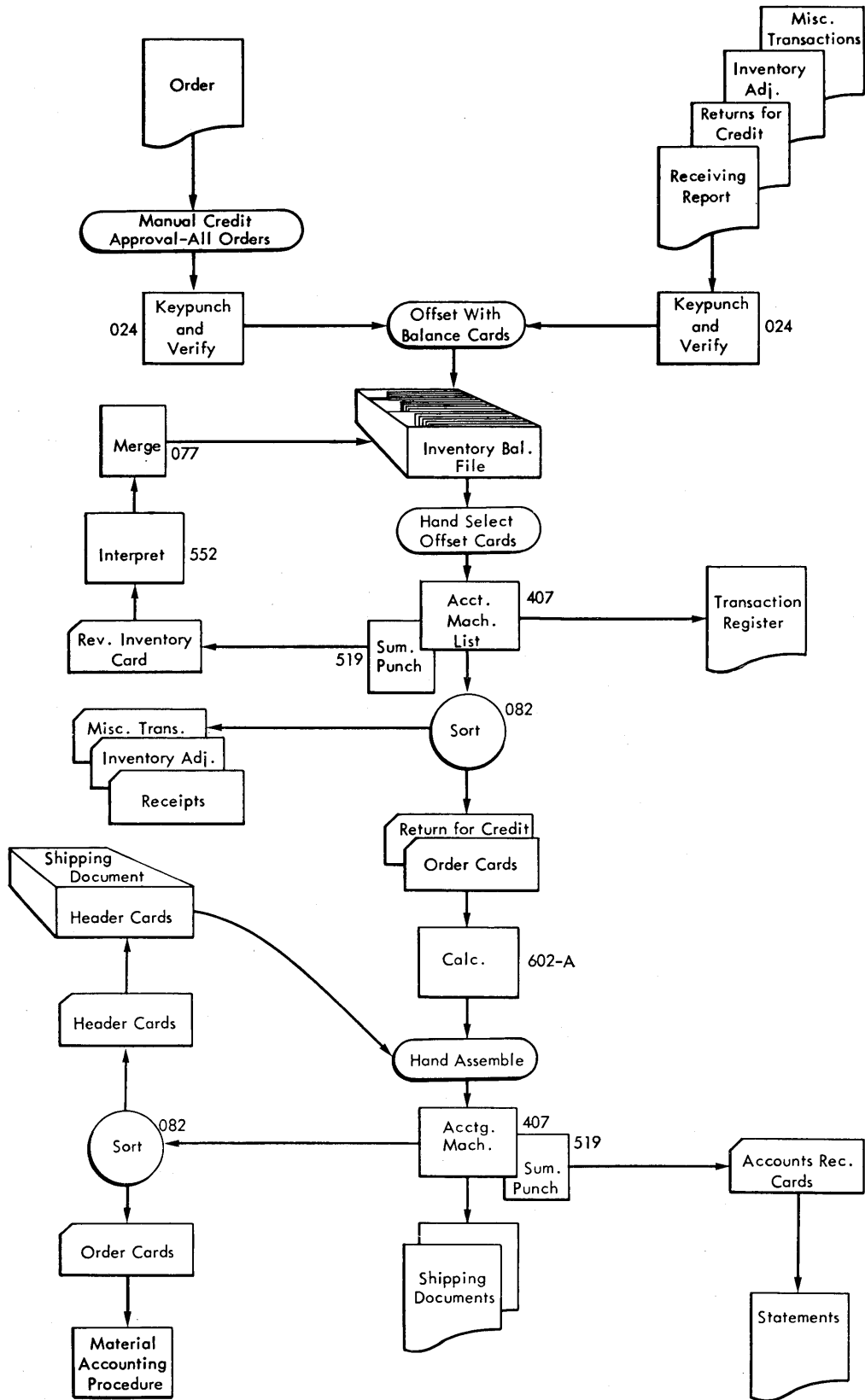

FIGURE 1. FLOW CHART OF INVENTORY, BILLING AND ACCOUNTS RECEIVABLE

IBM 305 RAMAC Approach

BECAUSE the files are located *in the machine*, most of these steps are eliminated when the same application is done on the IBM 305. Figure 2 shows the RAMAC approach. The cards are punched and verified as before, but because the machine will do the editing and credit checks, these steps are eliminated. The cards are placed in the input hopper, and the machine, through programming,

1. determines availability of each item ordered,
2. prices each item,
3. adjusts stock balances in the memory,
4. prints out an invoice,
5. punches transaction cards from which a transaction register can be listed,
6. punches accounts receivable cards which can be combined with the transaction cards to list detailed statements,
7. punches a warning card whenever the balance of an inventory item drops below a predetermined level,
8. punches a back-order card for each item back-ordered, and
9. accumulates usage data, which can be unloaded at intervals for sales analyses.

Using the offset punched-card system, all the filing must be done before the cards are run through the accounting machine. Under the RAMAC system, the cards may be inserted at any time, without sorting.

The console, which is part of the RAMAC system, contains a keyboard and a typewriter that allow an operator to make inquiries into the status of any account in the memory. Because the accounts are constantly being posted, this inquiry allows the operator to obtain a truly *current* balance almost instantly.

Because the machine can perform logical operations under the control of its program, such routine clerical functions as determining whether there is enough stock to fill an order, whether the stock has dropped below the re-order point, or whether the customer has exceeded his allowed credit can be performed automatically by the machine. For example, as each

invoice is written, a credit check can be made to determine if the sale causes the customer's credit maximum to be exceeded. If the maximum is exceeded, the machine can be programmed to print a signal on the margin of the form to indicate that the order requires the approval of the credit manager. In this way, only the exceptions must be reviewed manually.

Because of the huge memory capacity, it is possible to store entire price or rate tables in the machine for rapid reference. This facility allows the machine to price items or services on the basis of quantity ordered or amount used.

It is possible in many instances to store all the accounts of a business in the machine. The machine will perform all accounting functions on these records, updating them for each transaction. For example, the machine could handle inventory control and billing as its primary application, producing accounts receivable records and sales analyses at intervals. The costs of new material added to inventory could be distributed to vendor accounts, which would be referred to at intervals for the determination of accounts payable. Periodically, the machine could prepare the payroll and distribute labor costs to the proper accounts.

Advantages

Transactions are posted as they occur. This leads to the availability of more timely information and closer control over business transactions. For example, in the inventory control application just presented, receipts are immediately entered into the inventory accounts and issues are immediately extracted. The item account therefore constantly reflects the current balance of items on hand. Closer control over inventory results in reduced inventory charges and increased service to customers by reducing back orders.

Continuous in-line processing eliminates the need for transactions of a like kind to accumulate before making a run. This makes possible a continuous flow of orders through the office and warehouse, resulting in a much smoother operation and better service. The procedures made possible by the ability to store five million characters of information and to obtain them from memory at a high rate of speed may eliminate the need for sorting, collating and successive runs.

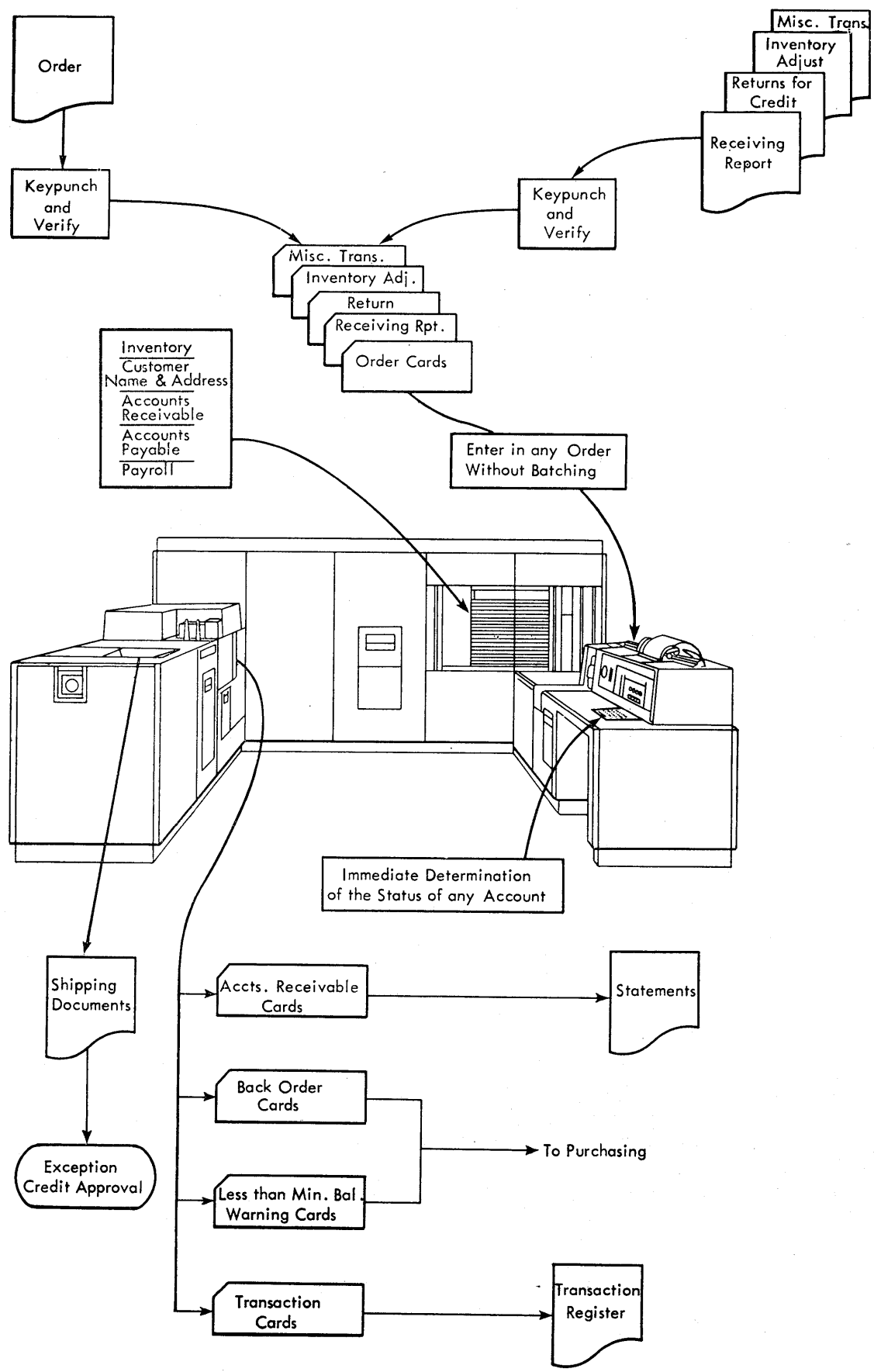

FIGURE 2. FLOW CHART OF INVENTORY, BILLING AND ACCOUNTS RECEIVABLE ON RAMAC

Random manual inquiry to any part of the stored record allows a truly current balance to be obtained for any account almost instantaneously by an operator.

Current processing of minute-by-minute data means dynamic accounting instead of a history for management to review.

Operating Speeds

The operating speeds of the machine units will be quoted when the individual units are discussed. Some of the operating times will appear slow in comparison with other electronic machines. However, it should be remembered that the 305 is an *accounting machine* with calculating ability. Most operations may be overlapped, so the actual processing time has almost no relation to the time obtained by adding up the operating times of the individual components. For example, at a given instant the machine may be printing a line on an invoice, punching a transaction card, assembling the detail of the following transaction in the processing unit, seeking a record in the random-access memory, and reading in information from a card for later processing.

To determine the time required for a given program, it will be necessary to consider not only the component speeds but also the amount of overlapping that can be obtained. This can be determined accurately only when the application has been programmed. However, an indication of the over-all speed may be obtained from the programming of a number of typical applications in which the machine would completely process about 10,000 transactions in an 8-hour day. Methods of determining the exact processing time and of obtaining maximum overlapping of operations will be discussed later.

SYSTEM ORGANIZATION

ANY processing machine of this type has three general types of elements: input, processing and output. Raw information is fed into the machine through input units. It is processed and digested in the processing unit, and the results are obtained from the machine through the output units. These elements are present in all accounting machines.

It is usual for the processing unit to have a control

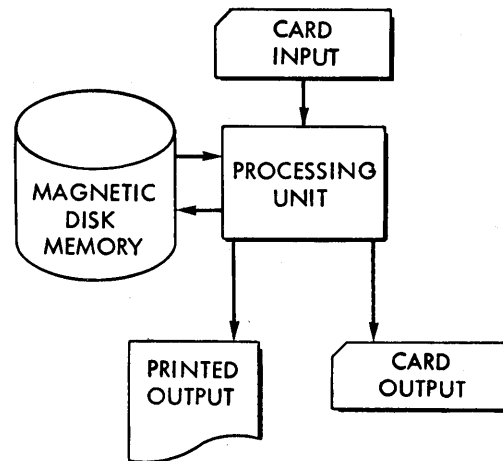

FIGURE 3. GENERAL DIAGRAM OF THE 305 SYSTEM

section that determines the sequence of processing. An example of this type of control is the wired control panel, where the pattern of the wires determines the operations that are performed. Another type of control is the *stored program* that will be discussed later.

In addition to these three types of elements, the IBM 305 contains a random-access memory unit that places a huge reservoir of business facts at the machine's disposal. Because the machine can look up these facts as needed, it can process transactions in random order.

Figure 3 is a general diagram of the 305 system. Information is entered into the system through an input card reader. When called for by the control unit, this information enters the processing unit. Processing consists of assembling information for output documents, making logical decisions, and maintaining and updating the accounting records that are stored in the machine in the random-access memory. The results from the processing unit may be punched into IBM cards in the 323 Punch, printed on the forms passing through the 370 Printer, or both.

Machine Components

Processing Unit. The processing unit contains a magnetic drum, on which there are storage tracks for program instructions, arithmetic and logic, and information being processed. The processing unit also contains a 100-character magnetic core unit, that is used for all transfers of information, and the control circuits for the processing operations.

Card Reader. In general, the information to be entered into the system is punched into IBM cards and entered through the card reader. The card reader is a parallel-type card feed containing two reading stations of 80 reading brushes each. Cards are fed face-down, 12-edge first. The feed hopper can hold up to 800 cards.

The card feed operates independently of all other input-output units. Cards are fed under the control of the program. The maximum rate of feeding is 125 cards per minute.

As the cards pass through the reader, the 80 columns of information are read from the card, translated into the code used in the machine, and recorded on the input storage track on the magnetic drum in the processing unit.

Information from the card is recorded in the first 80 positions of the 100-position drum track. These positions are numbered 00-79. Card column 1 is recorded at track position 00, card column 2 at 01; card column 80 at 79. Because the track contains more positions than the card contains columns, positions 80-99 do not contain input information.

When the cards have passed through the feed, they enter the stacker. The stacker holds approximately 1000 cards. The stacker may be emptied while the machine is in operation. A stacker stop switch is provided to stop the machine when the stacker is filled to capacity.

If the cards being read have mark-sense marks on them, the marks must be on the front of the cards only. Otherwise, the electronic circuits used for card reading could detect the marks, resulting in possible erroneous readings.

Output Printer. The output printer may be used to prepare documents while the transactions are being posted in the machine. The printer is a serial printing device that prints from a single, octagonal type-stick that moves rapidly across the form from left to right. The complete alphabet, the numbers 0-9, and 11 special characters may be printed. Horizontal spacing is 10 characters per inch, and an 8-inch line (80 characters) may be printed. To print an 80-character line and return the carriage requires approximately two seconds. Shorter lines are printed in less time.

The information to be printed is taken from an output track on the processing drum. Special format control is provided on the printer to allow the character stored in any output track position to be printed in any printing position. Line program selectors are provided on the control panel to allow a number of different printing formats to be selected. The control panel also provides such functions as zone elimination, variable line-spacing, and special character insertion.

Tape-Controlled Carriage. The tape-controlled carriage controls the vertical movement of forms in the 370 printer. The forms tractors are adjustable horizontally to accommodate forms of up to 16 inches in width, including feeding strips. Continuous form paper with standard marginal punching must be used. The maximum length of a form is 17 inches.

The tractors are controlled by punched holes in a paper tape that exactly corresponds in length to the length of one or more forms. The tape moves through a reading head in synchronism with the movement of forms through the tractor, and the holes in the tape are read by the machine to determine the position of the form for printing operations. Seven control channels are provided; six for line stops and the seventh for overflow.

Wiring on the printer control panel allows the selection of single, double or triple spacing between printing lines. These spacings are performed between lines without loss of time. Standard vertical spacing is six lines per inch.

The length of the printing line has a limit of eight inches. When sixteen-inch wide forms are used, the eight-inch printing area is centered in the form area, providing a maximum margin of four inches on either side. Forms of smaller width may be shifted (limited by the width of the form) to effect a shift of the eight-inch printing area on the form.

The platen can be de-clutched to synchronize the control tape with the form by pushing in the form positioning knob. Depressing the tape restore key causes the tape to be advanced to the home position, as indicated by a hole in channel 1.

A form-feed stop key is provided. When depressed, it stops the operation of the forms tractor and of the printer. A form stop lever is provided to stop the

printer when the paper supply is exhausted. When the printer is used in the system, the entire machine stops when the printer is instructed to print and fails to respond.

The print impression control should be used in the minimum position for single-part forms. Heavier impressions should be used only to darken printing on carbon copies of multiple-part forms — never to compensate for a worn or dry ribbon.

Card Punch. The card punch is used only as an output device, and punches up to 100 cards per minute, depending on the program. The punch receives its information from the same output track that is used by the printer; therefore it is possible to print and punch at the same time. Separate format control is provided for the punch, and by control-panel wiring any 80 characters of the possible 100 characters on the output track may be punched. A complete 80-column card is punched in 600 milliseconds. It is possible to perform gangpunching, double-punch and blank-column detection, and operations involving column-splitting and character emitting. However, no X-control is available for gangpunch control.

Magnetic Disk Storage. To perform in-line processing, the machine must automatically obtain any record it requires in a minimum of time. This ability is provided by the magnetic disk storage. This unit consists of 50 metal disks about two feet in diameter that are coated on both sides with a ferrous oxide recording material. Slightly separated from one another, these disks are mounted on a vertical shaft, and they revolve at 1200 rpm while the machine is in operation.

Information is stored in the form of magnetized spots in tracks around the disks. There are 100 concentric tracks on each disk. These tracks occupy the outer five inches of the disk surface.

At the side of the stack of disks there is an access arm that moves under electronic control to any desired track on any disk (Figure 4). Magnetic recording heads mounted on the access arm read or write information on the disks. The arm is forked, and when the fork enters the stack of disks it carries a recording head to either side of the disk that the arm straddles. When the arm is positioned on a disk it is possible to read or write on either side of the disk;

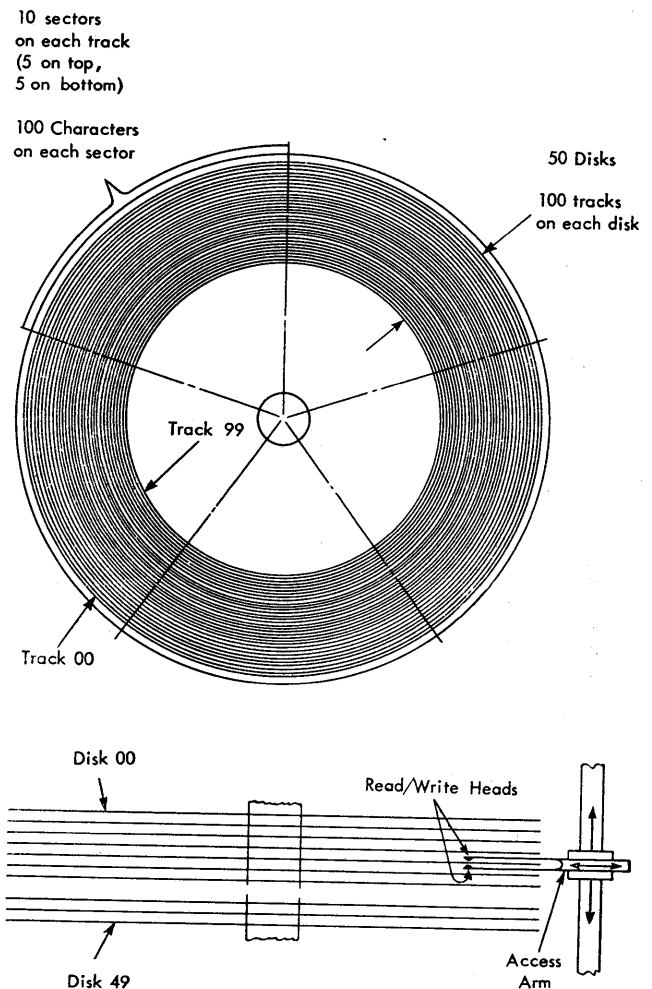

FIGURE 4. SCHEMATIC OF DISK STORAGE

therefore a disk track may be thought of as existing on both the top and the bottom of a disk.

The disk tracks are subdivided into sectors. There are ten sectors on a track; five on the top of the disk and five on the bottom. Each sector can store a 100-character accounting record. The record is stored as a series of magnetic spots recorded in the sector on the track. By storing ten 100-character records on each of 100 tracks on each of 50 disks, it is possible to store 5,000,000 alphanumerical characters in the unit.

The magnetic disks can be used repetitively to store new information. Each time new information is stored in a sector it erases the information that was formerly stored there. Records may be read from the disks as often as desired, provided they are not written over or erased by the program.

Console. The console provides manual and semi-automatic control of the machine for program checking. The console consists of a keyboard, typewriter, signal lights and control keys. The typewriter may be used for output of manual inquiries from the disk storage and process drum storage, or it may be used as a supplementary printer under the control of the program. The typing speed is 10 characters per second.

Associated with the typewriter is a control panel that establishes format control for the records that are typed on the typewriter.

The keyboard is similar to the unit found on the IBM 24 Card Punch. Through the use of the keyboard, inquiries for records are entered into the ma-

chine. The desired record is transferred from the magnetic-disk storage to the inquiry track on the processing drum. From this track, the record is typed under the format established by the typewriter control panel. Corrections to the information in the storage may be made by the operator from the keyboard if proper programming is in effect.

The console also contains a panel of indicator lights that show where the machine stands in the program sequence. There are also lights that inform the operator if the machine detects an error in the transfer of information through the system. The checking of information is discussed in a later section.

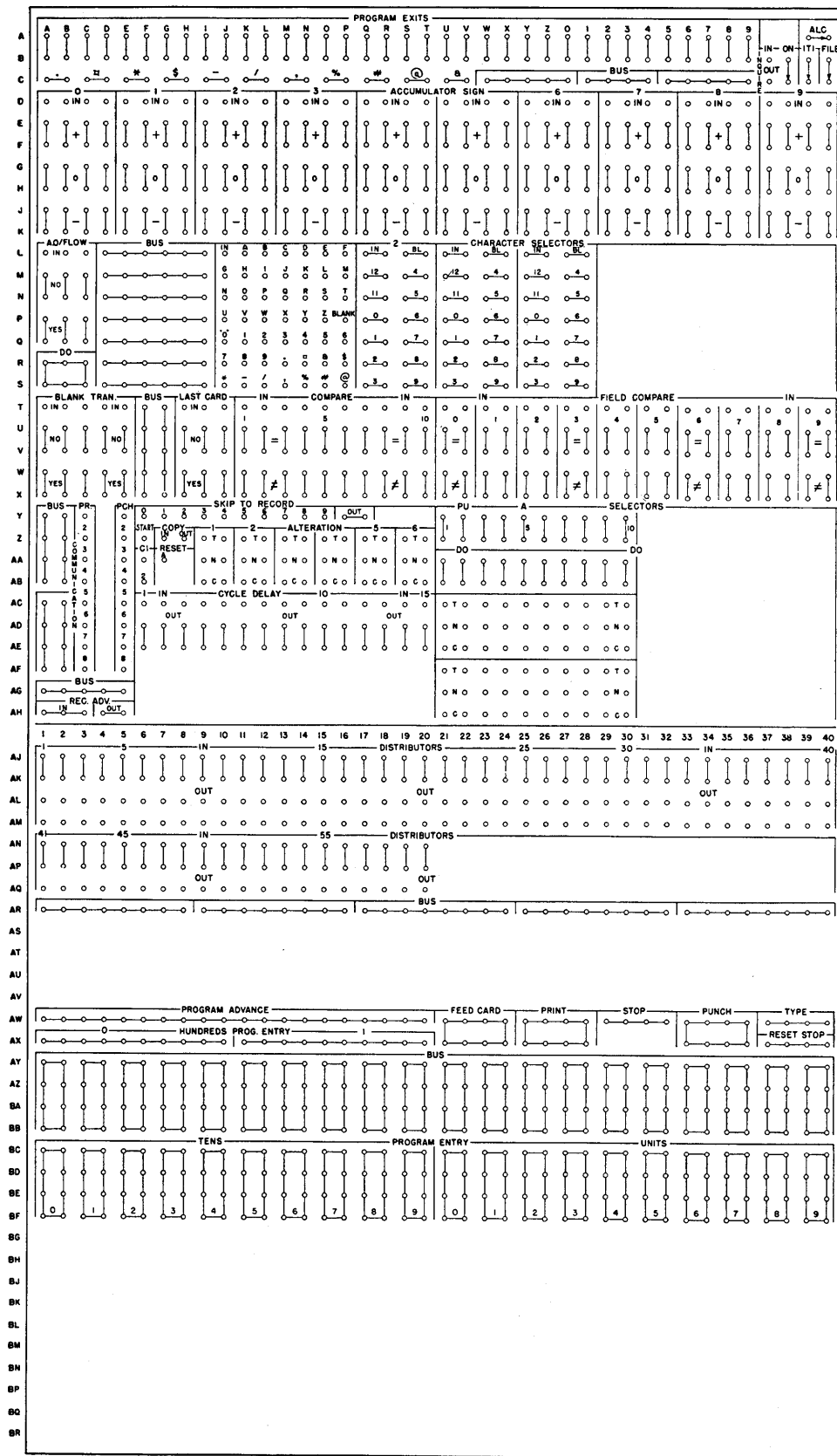

FIGURE 5. PROCESS CONTROL PANEL

PROGRAMMING

FOR the greatest flexibility of operation, the sequence of processing is controlled by a stored program that is modified on the basis of logical decisions made through the control-panel wiring.

Stored Program

The transmission of information through the machine is controlled by a sequence of program steps, each of which performs some basic, necessary operation. As an example, suppose the machine has stored the information that 50 gallons of white paint are in stock. An order arrives for 15 gallons of white paint. A human stock clerk would look at the paint and decide that the order could be filled. The machine makes the same decision by arithmetic. The way the machine makes this decision may be diagrammed logically as follows:

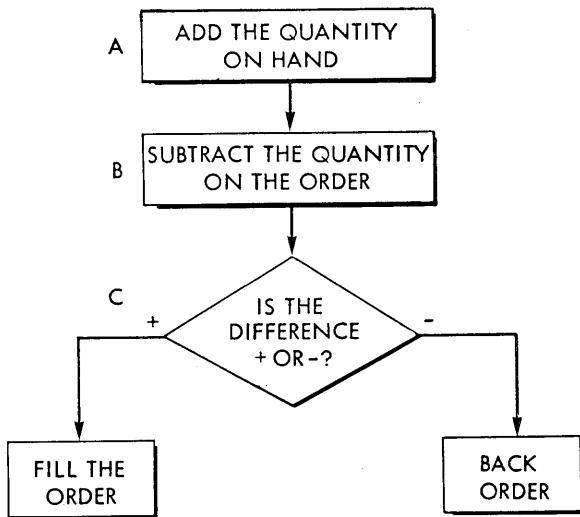

This sequence of instructions can be understood by anyone who reads English. However, the machine reads a much more concise language called stored program coding. Instead of the English phrase, "add the quantity on hand," the machine reads a coded instruction something like W22L4905 that causes it to perform the required operation. The programmer can express as a series of these coded instructions all the steps that the machine must take to process the order. These program instructions are then loaded into the machine, and the machine reads the instructions and performs the sequence of operations each time an order is to be processed.

Steps A and B in the preceding logic diagram would each be performed as the result of a stored program instruction. When it is necessary to make decisions, the process control panel is used.

Process Control Panel

The process control panel is shown in Figure 5. To facilitate reference to specific hubs on the control panel, the rows are numbered 1 through 40 horizontally and lettered A through BR vertically.

The logical elements of the machine are arranged as selectors on the process control panel. Whenever the machine must make a logical decision, the program is brought to the control panel as an electrical impulse. This impulse is wired through the selectors to perform logical decisions.

For example, there are ten accumulators each of which has a sign selector arranged as shown in Figure 6. In each vertical row of hubs there is an IN hub, a pair of hubs marked +, a pair marked 0, and a pair marked —. When the accumulator is reset, or when it contains a zero balance, an internal connection is made between the IN hub and the 0 hubs. When an amount is added into the accumulator, the accumulator takes on a positive sign, and a connection is made between the IN hub and the + hubs. When a greater negative amount is entered, the accumulator takes on a negative sign, and a connection is made between the IN hub and the — hub. Only one of these three connections is made at any one time.

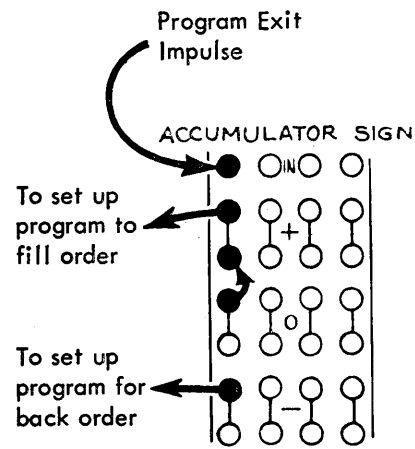

FIGURE 6. METHOD OF BRANCHING BY CONTROL PANEL WIRING

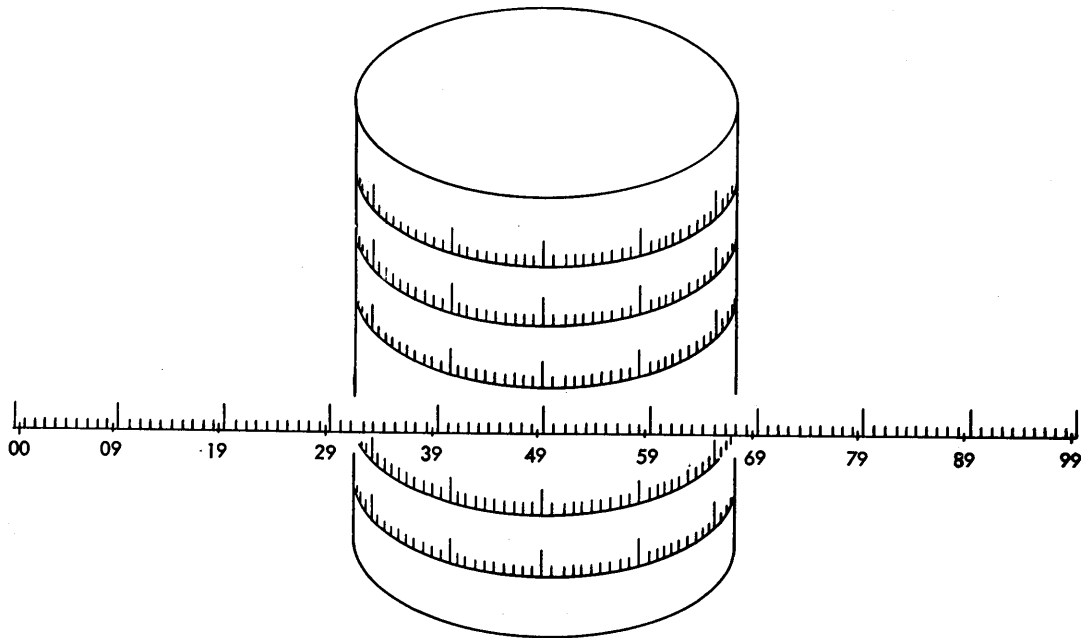

FIGURE 7. GRAPHIC REPRESENTATION OF DRUM TRACKS AND DISK TRACKS

In the example just discussed, the program would be arranged so that after the stored program step, "subtract the quantity on the order," was completed, the control would be brought to the control panel as an electrical impulse. This impulse would be wired to the IN hub to test the sign of the accumulator. If the accumulator were positive ($50 - 15$ gallons = $+ 35$ gallons) it would indicate that the order could be filled, and the test impulse, emerging from the $+$ hub would be wired to set up the first step of a sequence of instructions that would result in filling the order.

A zero accumulator would indicate that there is exactly enough paint to fill the order, so this hub may be connected to the $+$ hub to cause the same program step to be set up. A negative accumulator would indicate that there is not enough paint to fill the order, so if the test impulse emerges from the $-$ hub, it is wired to set up the first step of a sequence of instructions that causes the item to be back ordered.

Automatic selection of machine routines in this manner is called *branching*. Note that the logical elements of the machine may be tested in combination, by wiring the test impulse through several selectors to set up one of a number of alternative program sequences.

Processing Drum

The processing unit contains a magnetic drum, on which the program instructions are stored. The drum also contains storage space for records being processed and updated, for input and output, and for other functions that will be described later. The drum revolves at 6000 rpm; it takes one revolution in 10 milliseconds (.010 seconds).

A number of magnetic reading and recording heads are arranged along the length of the drum. Each of these is designed to read and write magnetic spots in a narrow band around the drum. These bands are called drum tracks. Each track is divided into 100 positions, and a single character of information may be stored in each position. Figure 7 shows a graphic representation of a drum track where the track has been cut at the starting point and unrolled from the drum. The 100 possible recording positions have been given *addresses* from 00 to 99. (An *address* is a group of characters specifying a location in the machine.) The first character on the track is recorded in position 00; the second character is recorded at 01, etc., and the 100th character is recorded at position 99.

CARD, TRACK, OR RECORD		CUST No.	CUST ORDER No.	ORDER DATE M D Y	ITEM 1		ITEM 2		ITEM 3		ITEM 4		ITEM 5		ITEM 6		ITEM 7		ITEM 8						
					ITEM ADDR	QTY	ITEM ADDR	QTY	ITEM ADDR	QTY	ITEM ADDR	QTY	ITEM ADDR	QTY	ITEM ADDR	QTY	ITEM ADDR	QTY	ITEM ADDR	QTY	A	SALES MAN	CR. MAX.	PRESENT BALANCE	
INPUT ORDER CARD TRANSFERRED TO TRACK W		0	5	10	15	20	25	30	35	40	45	50	55	60	65	70	75	80	85	90	95				
CUSTOMER DISC RECORD TRANSFERRED TO TRACK X		CUST No.	CUSTOMER NAME					ADDRESS					CITY, STATE					A	SALES MAN	CR. MAX.	PRESENT BALANCE				
ITEM DISK RECORD TRANSFERRED TO TRACK Y		ITEM No.	ITEM DESCRIPTION					UNIT PRICE	ON HAND	ON ORDER	ON BACK ORDER	MIN BAL.	ITEM CL.	ITEM CODE											
CONSTANTS & LEGENDS RECORDED ON TRACK Z		0	1	2	3	4	5	6	7	8	9	BACK ORDER TRADE DISCOUNT EXCISE TAX													

FIGURE 8. TRACK LAYOUT DIAGRAM

Processing Tracks

Four tracks on the drum are designed specifically for the storage of information being processed. These four tracks have the addresses W, X, Y and Z. Each of these tracks contains 100 positions with addresses 00 to 99. Therefore the address W05 locates the sixth character on process track W, and the address Z99 locates the last (100th) character on process track Z.

Record Layout

For program planning, the location of information on the disk and drum tracks must be plotted. The track diagrams shown in Figure 8 are an example. Track diagrams are marked with track locations from 00 to 99. The positions into which information is transferred are blocked out on the diagram as the program is written. Laying out these tracks is very similar to making IBM card layouts.

If possible, the first five positions of the disk records should be recorded with the disk address so that a program check may be made on the location of the access arm in the disk memory. The method of making this programmed check is shown in later programs.

Constants and Legends

In Figure 8, track Z has been recorded with constants and legends that will be required in the course of processing. Note the position of the digits 0-9; the address Z00 emits a zero, the address Z05 emits a 5, etc. The legends, when required, may be transferred in a single instruction.

Program and General Storage Tracks (Figure 9)

Twenty tracks on the processing drum are arranged to store program instructions. Because each instruction takes up to ten characters, ten instructions are stored on each track. Up to 200 instructions may be stored on these 20 tracks at any one time. When they are not required for the storage of program instructions, these tracks may be used for the storage of other information.

The 200 instructions are given numbers between 000 and 199 to correspond with the order in which the machine executes them. After executing any instruction, the machine proceeds automatically to the next higher-numbered instruction unless it is desired to skip to some other instruction. In this way, the program may advance from step 000 to step 199. After step 199, the program returns to step 000 unless it is transferred elsewhere. The method of making these transfers is explained later.

The program and general storage tracks are given the addresses 0, 1, 2, 3, 4, 5, 6, 7, 8, 9, &, A, B, C, D, E, F, G, H, and I. Program steps 000 to 009 are recorded on track 0, steps 010 to 019 on track 1, etc. The chart shown in Figure 9 gives the locations of all of the instructions on the program tracks.

The ten-character instructions are arranged as follows:

FROM		TO		No. Characters	Control
Track	Position	Track	Position		

CARD TRACK OR RECORD	STEP	01	02	03	04	05	06	07	08	09
TRACK 0	STEP 00	01	02	03	04	05	06	07	08	09
TRACK 1	STEP 10	11	12	13	14	15	16	17	18	19
TRACK 2	STEP 20	21	22	23	24	25	26	27	28	29
TRACK 3	STEP 30	31	32	33	34	35	36	37	38	39
TRACK 4	STEP 40	41	42	43	44	45	46	47	48	49
TRACK 5	STEP 50	51	52	53	54	55	56	57	58	59
TRACK 6	STEP 60	61	62	63	64	65	66	67	68	69
TRACK 7	STEP 70	71	72	73	74	75	76	77	78	79
TRACK 8	STEP 80	81	82	83	84	85	86	87	88	89
TRACK 9	STEP 90	91	92	93	94	95	96	97	98	99
TRACK \bar{Q}	STEP 100	101	102	103	104	105	106	107	108	109
TRACK A	STEP 110	111	112	113	114	115	116	117	118	119
TRACK B	STEP 120	121	122	123	124	125	126	127	128	129
TRACK C	STEP 130	131	132	133	134	135	136	137	138	139
TRACK D	STEP 140	141	142	143	144	145	146	147	148	149
TRACK E	STEP 150	151	152	153	154	155	156	157	158	159
TRACK F	STEP 160	161	162	163	164	165	166	167	168	169
TRACK G	STEP 170	171	172	173	174	175	176	177	178	179
TRACK H	STEP 180	181	182	183	184	185	186	187	188	189
TRACK I	STEP 190	191	192	193	194	195	196	197	198	199

FIGURE 9. LOCATION OF THE INSTRUCTIONS ON THE PROGRAM TRACKS

The character in the first position of the instruction specifies the track on which the desired information is stored. The next two positions specify the location of the low-order position of the information. In a similar manner, the next three positions of the instruction specify the low-order position of the location to which the information is to be transferred. The next two positions of the instruction define how many characters are to be transferred. The remaining two positions are control codes that will be explained later.

Magnetic-Core Unit

The stored program instructions control the flow of information through the machine much as a switchman controls the flow of trains through a railway junction. By the same analogy, the magnetic-core unit corresponds to the junction. The machine assembles information from various sources into a form that may be used for output by making a series

of transfers of the pieces of information. To accomplish these transfers, an intermediate storage unit is necessary.

The magnetic-core unit is the channel through which all information is transferred. This unit is arranged to store from 1 to 100 characters. Under the control of the stored program, the desired information is read from a source track into the magnetic cores on one revolution of the processing drum, and on the following revolution the information is read from the cores and recorded in the specified positions of the receiving track. The cores serve as an intermediate storage unit on each transfer.

As an example, suppose that it is desired to transfer a part number, recorded in positions 05-09 of processing track W, into positions 29-33 of processing track Z. Five positions are read from track W into the magnetic cores, and then recorded from the cores onto track Z (Figure 10). The low-order position on track W is 09, and the low-order position on track Z is 33; therefore the necessary program instruction is:

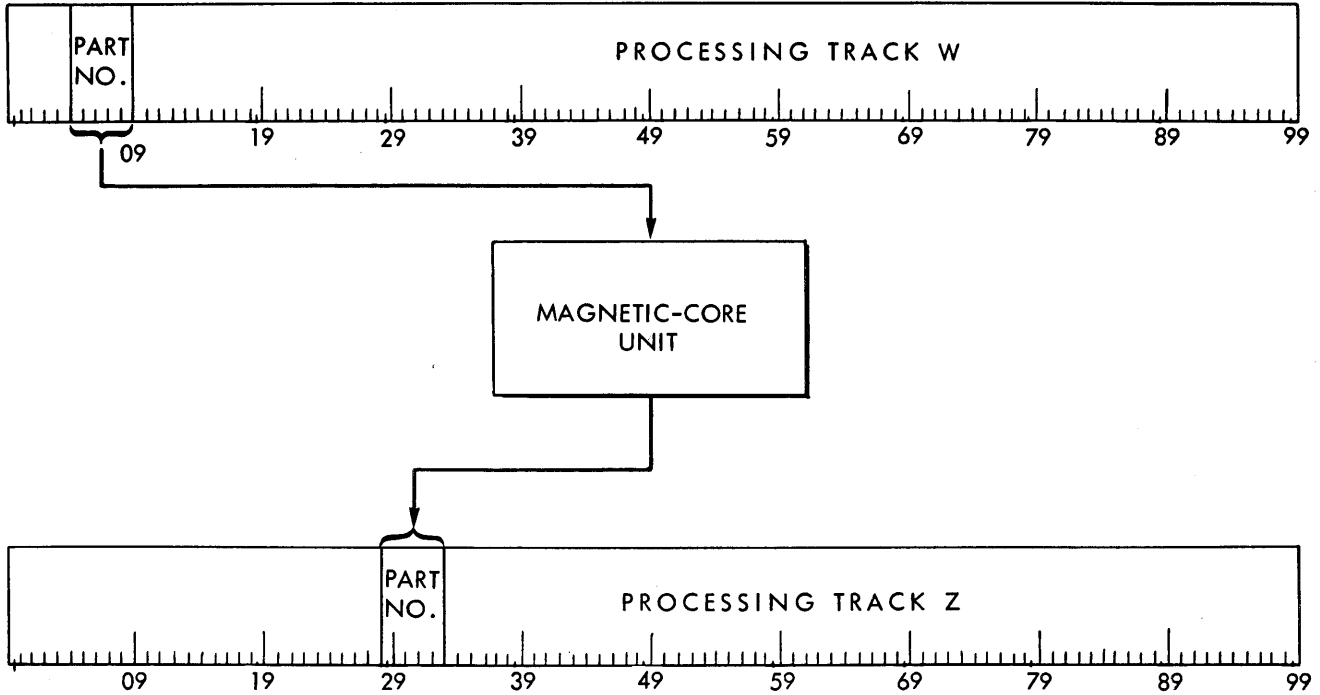

FIGURE 10. SCHEMATIC OF A NORMAL TRANSFER OPERATION

FROM		TO		No. Characters	Control
Track	Position	Track	Position		
W	09	Z	33	05	

The normal transfer operation in the processing unit requires 30 milliseconds for completion. During the first 10 milliseconds, the instruction is read from the program track and used to set up the required paths for the transfer of information. This is called the *Instruction cycle*. During the second ten milliseconds the information from the sending track is loaded into the magnetic-core unit. This is called the *From cycle*. The final 10 milliseconds are required to read out the core unit and record the contents on the receiving track. This is called the *To cycle*. In terms of the usual stored program concept, the first 10 milliseconds constitute the *instruction cycle*, and the next 20 milliseconds are the *execute cycle*. If there is no control code in the ninth position of the instruction, the machine immediately reads the next instruction, and the sequence is repeated.

Control Codes

If a control code is added to a program step, an additional 20 milliseconds is added to the 30 just described. During this 20 milliseconds, the control is brought to the control panel as an electrical impulse, which is used to test the logical selectors and perform other functions. The additional 20 milliseconds are required for the machine to step through two additional cycles which are called the *delay* and *exit* cycles.

A control code may be any letter, number or special character. When a control code is added to an instruction (in the ninth character of the instruction), after the instruction has been performed an impulse is emitted from the correspondingly-marked hub on the processing control panel. The control codes may be used in any order.

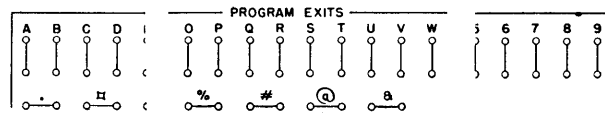

A-B, 1-36
C, 1-22

Program Exits. When a control code is attached to an instruction, an electrical impulse is emitted from the correspondingly marked program exit hubs. Simultaneously, the program sequence is halted. The impulse is used to test the logical selectors on the control panel, and a new

sequence of instructions may be initiated by the impulse on the basis of the setting of the logic selectors. The new sequence is established by wiring the impulse to the desired program entries.

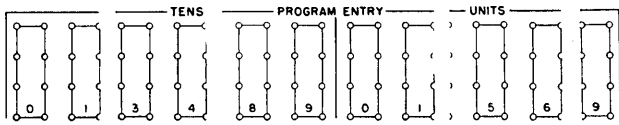

BC-BF, 1-40

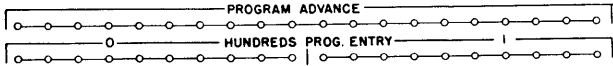

AW, 1-20
AX, 1-20

Program Entries. These hubs accept the PROGRAM EXIT impulse to set up the first step of a new sequence. Unless a new sequence is started in this manner, or by impulsing PROGRAM ADVANCE, the machine will stop.

The new stored program step is set up by impulsing a TENS hub and a UNITS hub that correspond to the number of the desired program steps, provided that the step is in the same hundred steps (000-099 or 100-199) as the step that caused the program exit. For example, to transfer the stored program from step 32 to step 68, the instruction for step 32 would have a control code added, giving the instruction the form:

FROM		TO		No. Characters	Control
Track	Position	Track	Position		
W	15	M	29	02	B

When the instruction is completed, an impulse is emitted from the PROGRAM EXIT B hub, and the program sequence is halted. The impulse would be wired (through distributors) to the PROGRAM ENTRY hubs, impulsing TENS hub 6 and UNITS hub 8. This sets up step 68 as the next step.

However, if the program is to be skipped to step 168, it would also be necessary to impulse the HUNDREDS PROGRAM ENTRY 1 hub. Similarly, to skip the program from step 132 to step 68, the impulse emitted as a result of the control code on step 132 would be wired to impulse the HUNDREDS hub 0, the TENS hub 6 and the UNITS hub 8. It is not necessary to impulse the HUNDREDS PROGRAM ENTRY when the program remains within the same hundred program steps. Figure 11 shows how these transfers are wired on the control panel.

Program Advance. When the program sequence is halted by the presence of a control code in the ninth position of an instruction, it is frequently desirable to return to the next program step. If the PROGRAM ADVANCE hubs are impulsed instead of PROGRAM ENTRY, the stored program instructions resume control on the next program step. Figure 11 shows wiring in which the control code K

causes the machine to print the record on the output track and resume operation on the next program step.

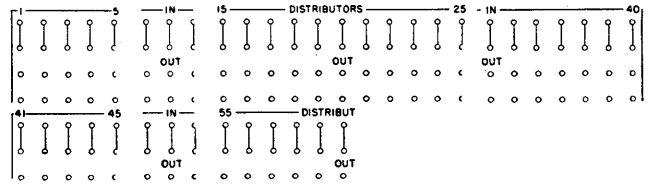

AJ-AM, 1-40
AN-AQ, 1-20

Distributors. Impulses that are used to perform several functions are wired through distributors, which serve the same function as split wires, but prevent possible back circuits. The impulse wired to the IN hub of a distributor is available at the associated OUT hubs, but impulses cannot travel between OUT hubs, or from an OUT hub to the IN hub. Any impulse except that from the OUT hub of another distributor may be wired through a distributor.

Input Track

Cards fed into the card reader are recorded on the input track. When the input has been checked, the input track is made available to the processing unit, where it has the address K. This track is addressed in the same manner as the other storage tracks, for transfers under stored program control. Thus, to transfer the entire input track to the processing track Y, the instruction is:

FROM		TO		No. Characters	Control
Track	Position	Track	Position		
K	99	Y	99	00	

To transfer the first 50 positions of the input track to the last 50 positions of program track 9, the instruction is

FROM		TO		No. Characters	Control
Track	Position	Track	Position		
K	49	9	99	50	

NOTE: The instruction just shown indicates that the input track may be used as a processing track, because it is possible to transfer part of the track without taking the entire 100 characters. However, when the input track is used in this manner it is not possible to feed the next card until the use of the input track

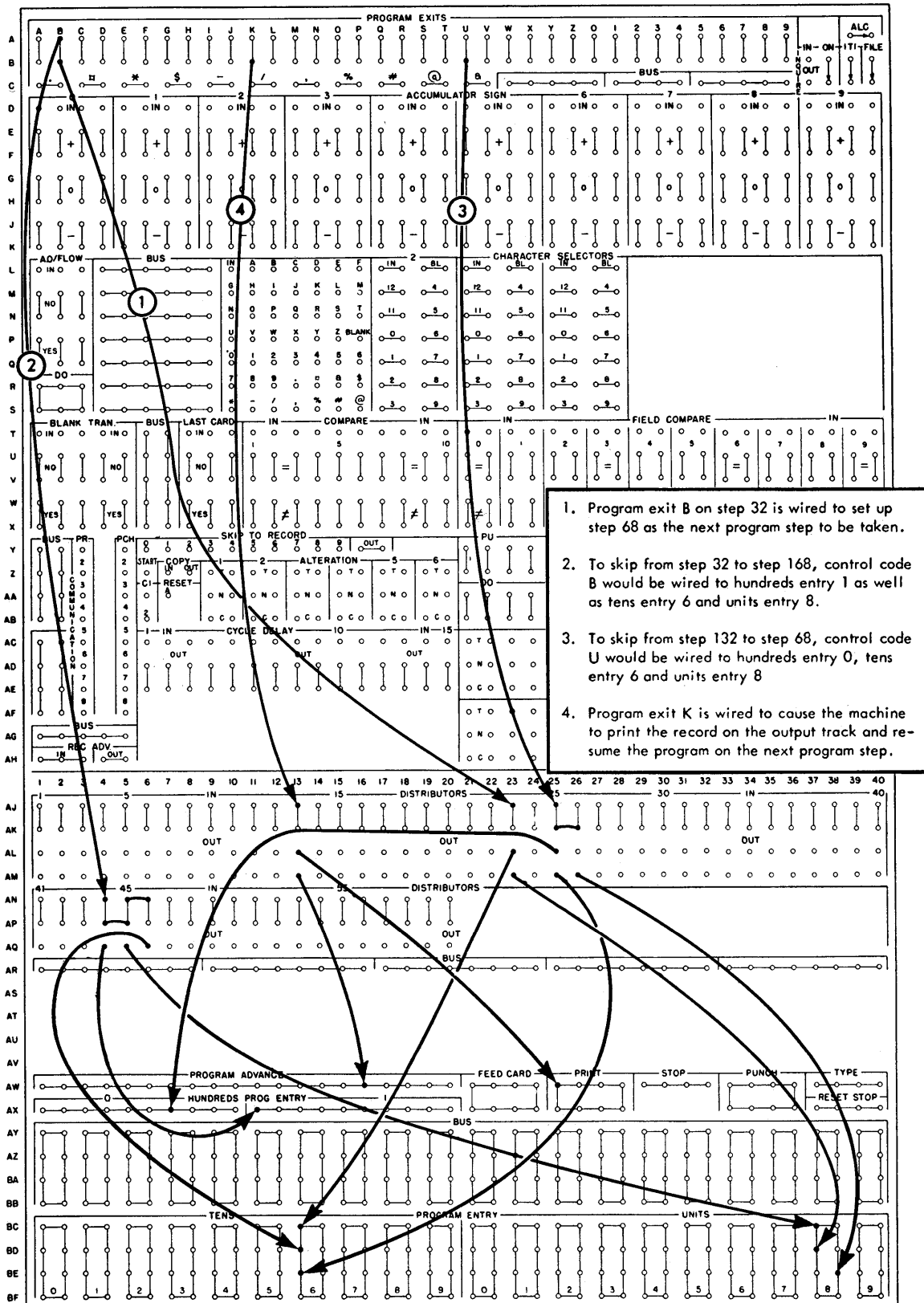
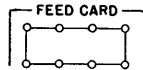

FIGURE 11. METHOD OF WIRING PROGRAM TRANSFERS

has been completed, and then about half a second is required for the next card to be fed and checked. Usually this time may be overlapped by transferring the entire input track to another processing track, and starting the feeding of another card while the first card is being processed. If the information on the input track is transferred to a processing track, the input track is freed to accept the next card.



AW-AX, 21-24

Feed Card. Impulsing these hubs causes the card reader to feed a card past each station. The card passing first reading is automatically coded and recorded on one input track. This recording is later transferred to another input track so that the recording may be compared against the reading of that same card as it passes second reading. If the two recordings compare (identical), the input track is made available to the processing unit.

Output Track

The output track has the address S. When information is transferred to the output track, it may be printed on the 370 Printer or punched into IBM cards in the 323 Punch. Format control on these units determines the arrangement of the printing or punching.

The instruction to transfer the entire processing track Z to the output track is:

FROM		TO		No. Characters	Control
Track	Position	Track	Position		
Z	9 9	S	9 9	0 0	

The instruction to transfer the first 32 positions of processing track Y to the last 32 positions of the output track is:

FROM		TO		No. Characters	Control
Track	Position	Track	Position		
Y	3 1	S	9 9	3 2	

NOTE: This instruction indicates that the output track may be used as a processing track, because it is possible to assemble records on the output track. However, some loss of time may be the result of this practice, because the output track cannot be altered while printing or punching is in progress. This facility is mentioned here because it may be of value when, due to a very involved program, all program and processing tracks are required for other storage.

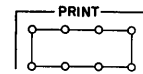

AW-AX, 25-28

Print. Impulsing these hubs causes the printer to print from the output track. Format control on the printer determines the arrangement of the printing.

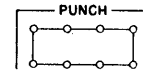

AW-AX, 33-36

Punch. Impulsing these hubs causes the output punch to punch from the output track. Format control on the punch allows control of which columns are punched.

Typewriter Output

The typewriter may be used to print out an auxiliary document, such as an invoice register, while the printer is printing the invoices. The typewriter may also be programmed to print out instructions to the operator and signals that unusual conditions have been encountered. For example, the typewriter may print out records that are out of stock or have fallen below the minimum balance. It may also print out legends such as "item record not in memory."

To cause the typewriter to operate from the program, the program instruction transfers the desired output record to track Q, the typewriter track. For example, to transfer the contents of track Y to track Q, the instruction would be

FROM		TO		No. Char-acters	Control
Track	Position	Track	Position		
Y	9 9	Q	9 9	0 0	F

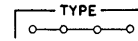

AW, 37-40

The control code on this instruction would be wired to TYPE on the control panel.

Type. When the typewriter at the console is used to print an auxiliary document, impulsing these hubs causes the typewriter to print the information recorded on the Q track. Format control on the typewriter control panel determines the arrangement in which this information is typed.

LOADING THE PROGRAM

BEFORE the machine can do any useful work, the program instructions must be recorded on the program storage tracks. However, the machine requires instructions to load its program instructions. These instructions may be entered into the machine by the use of the COPY hubs.

START-COPY
 | o | 8 87
 Z, 6
 Z, 7-8

Start. When the input card has fed past the second reading station, and the input track has been recorded and checked, this hub emits an impulse that may be wired to start the stored program at any desired step, and initiate other functions.

Copy. When the COPY IN hub is impulsed, the machine automatically transfers the input track to track I of the program storage tracks. When used for program storage, track I contains program instructions 190-199. If the input card is punched with instructions, it is possible to record up to eight instructions on track I by impulsing the COPY IN hub. The IN hub is usually impulsed from the START hub.

When the transfer to track I is completed, the OUT hub emits an impulse that may be wired to start the pro-

gram at step 190. The program thus set up can cause the feeding of more cards, and control the loading of these cards on other program tracks.

The following method of loading program instructions is presented as an example of the use of the machine elements that have been discussed. Many alternative ways to load the program will suggest themselves to the adept programmer.

The program loading cards are arranged as shown in Figures 12 and 13. Each card is transferred (by wiring COPY) to track I, where it represents program steps 190-197. Not all of the steps are needed when the program is loaded by this method; in fact, only three of these instructions will be used. The positions for instructions 193-197 (card columns 31-80) will be used to record five program steps of the final program. Program steps 190, 191 and 192 will transfer these five instructions from track I to their proper location, and then type them from the program tracks as a proof that the program is recorded correctly.

Figure 14 shows the control-panel wiring for this operation. When the START hub emits, it is wired to copy the first card from the input track to track I. When this operation is completed, the OUT hubs emit to transfer the program to step 190, and to cause another card to be fed and recorded on the input track.

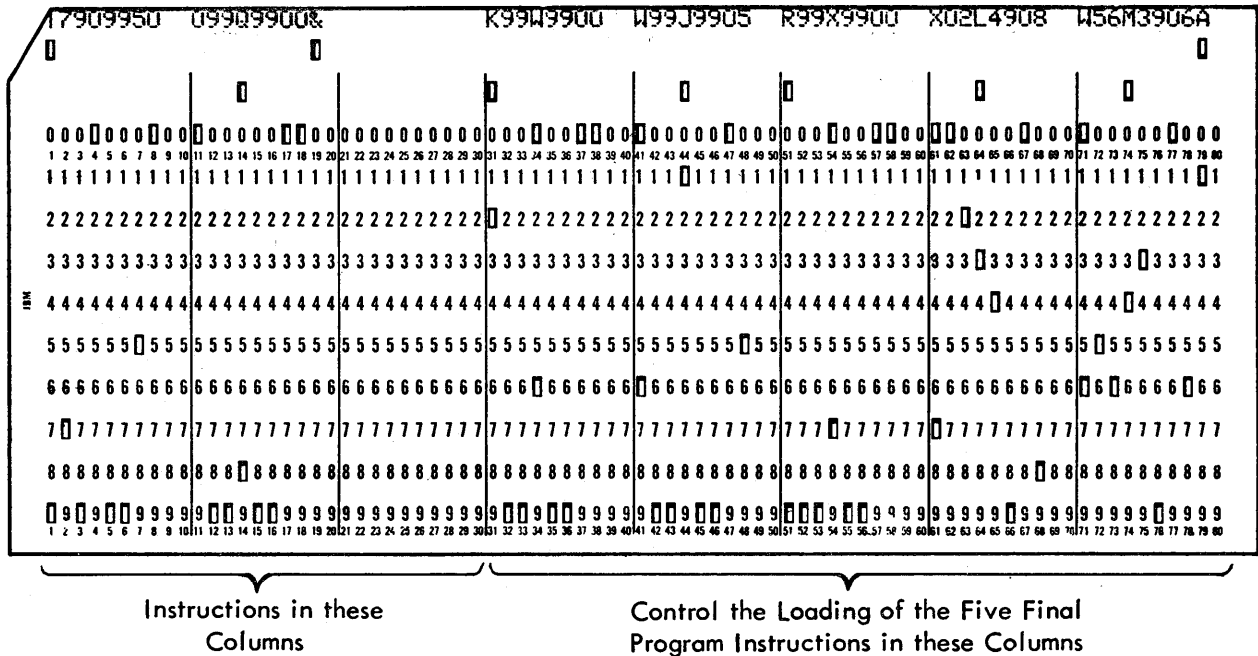

FIGURE 12. CARD USED FOR PROGRAM LOADING.

CARD NUMBER	INSTRUCTION IN COLUMNS 1-10				INSTRUCTION IN COLUMNS 11-20				FINAL PROGRAM INSTRUCTIONS IN COLUMNS 31-80
	From	To	No	Ctrl	From	To	No	Ctrl	
1	I 79	0 49	50	*		-			00-01-02-03-04
2	I 79	0 99	50		0 99	Q 99	00	&	05-06-07-08-09
3	I 79	1 49	50	*		-			10-11-12-13-14
4	I 79	1 99	50		1 99	Q 99	00	&	15-16-17-18-19
5	I 79	2 49	50	*		-			20-21-22-23-24
19	I 79	9 49	50	*		-			90-91-92-93-94
20	I 79	9 99	50		9 99	Q 99	00	&	95-96-97-98-99
21	I 79	& 49	50	*		-			100-101-102-103-104
22	I 79	& 99	50		& 99	Q 99	00	&	105-106-107-108-109
23	I 79	A 49	50	*		-			110-111-112-113-114
24	I 79	A 49	50		A 99	Q 99	00	&	120-121-122-123-124
25	I 79	B 49	50	*		-			120-121-122-123-124
39	I 79	W 49	50	*		-			190-191-192-193-194
40	I 79	W 99	50		W 99	Q 99	00		195-196-197-198-199

INSTRUCTIONS IN COLUMNS 21-30
OF LAST CARD ONLY

From	To	No	Ctrl
W 99	I 99	00	%

FIGURE 13. PROGRAM INSTRUCTIONS FOR LOADING THE PROGRAM

Step 190 transfers positions 30-79 of track I to the proper program track. If the first card contains program steps 00-04, instruction 190 of this card is written to transfer these five instructions to track 0, positions 00-49. The control code "*" attached to this instruction emerges as an electrical impulse on the PROGRAM EXIT * hub of the control panel.

This PROGRAM EXIT is wired to impulse COPY. This causes the next card to be transferred from the input track to track I. Again, the COPY OUT hubs feed a card and transfer control to step 190. If this second card on track I contains steps 05-09, the instruction from this card now recorded in step 190 causes these steps to be transferred to track 0, positions 50-99. Because there is no control code on this instruction, the program advances to step 191. Track 0 is now completed, so step 191 causes the contents of track 0 to be recorded on the typewriter track. The control code "&" on this instruction transfers control to the control

panel. This PROGRAM EXIT is wired through distributors to TYPE, and to copy the next card.

Subsequent cards would load program instructions into tracks 1-9, &, A-I, and as these tracks were completed they would be typed out to prove that the program was loaded correctly.

A difficulty arises when a full 200 program steps must be loaded, because steps 190-199 must be loaded on track I, which is being used for processing. One way around this difficulty is to assemble steps 190-199 on processing track W (cards 39 and 40, Figure 13) on the instructions at step 190, then on step 191 transfer track W to the typewriter track Q, and on step 192 for the last card transfer track W to track I, wiping out the control instructions. The control code "%" on this last step brings the control to the control panel, where it is wired to type the last 10 instructions, but because no new sequence is initiated by impulsing program entries, the machine will stop after this instruction.

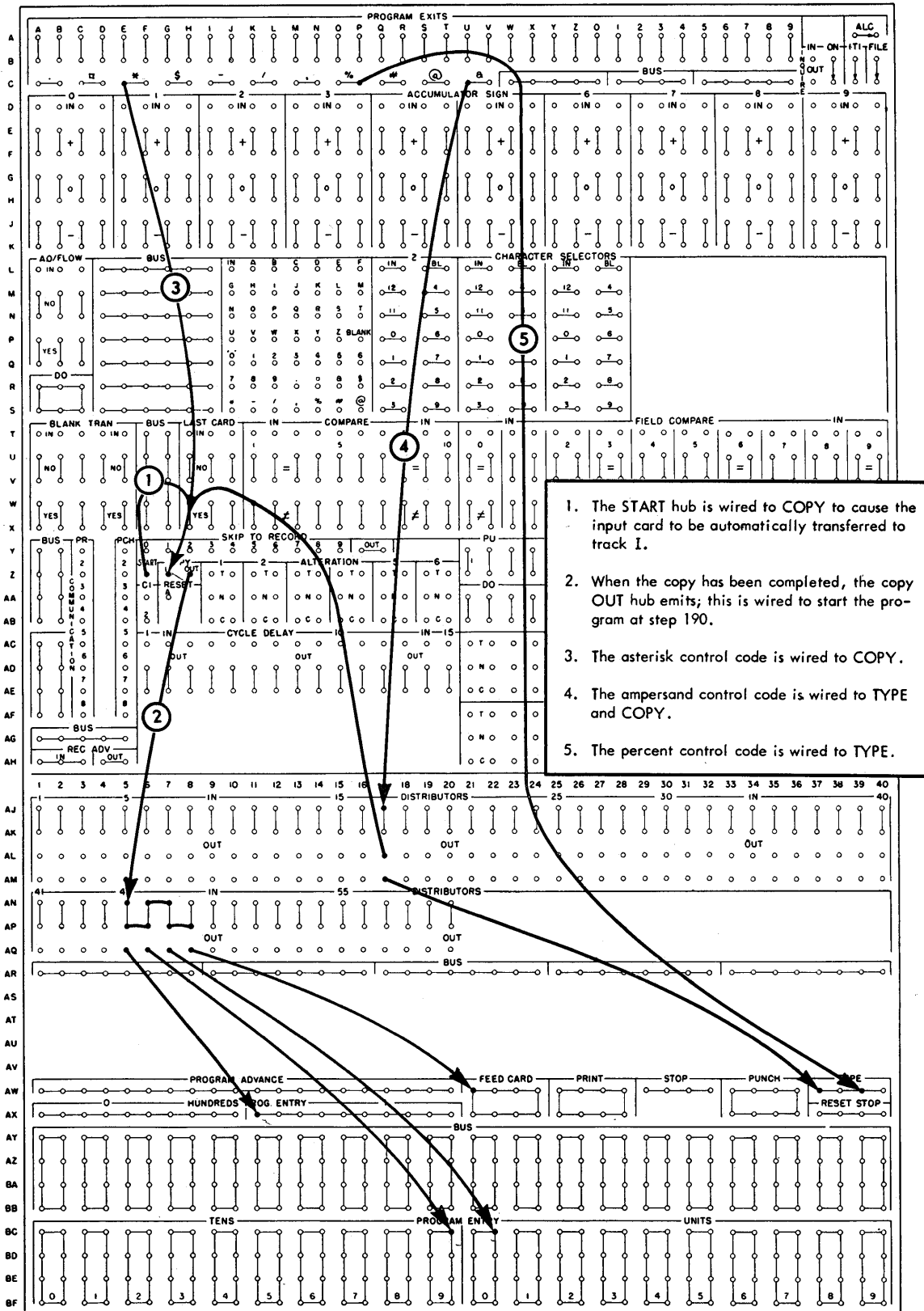

1. The START hub is wired to COPY to cause the input card to be automatically transferred to track I.
2. When the copy has been completed, the copy OUT hub emits; this is wired to start the program at step 190.
3. The asterisk control code is wired to COPY.
4. The ampersand control code is wired to TYPE and COPY.
5. The percent control code is wired to TYPE.

FIGURE 14. CONTROL PANEL WIRING FOR LOADING THE PROGRAM

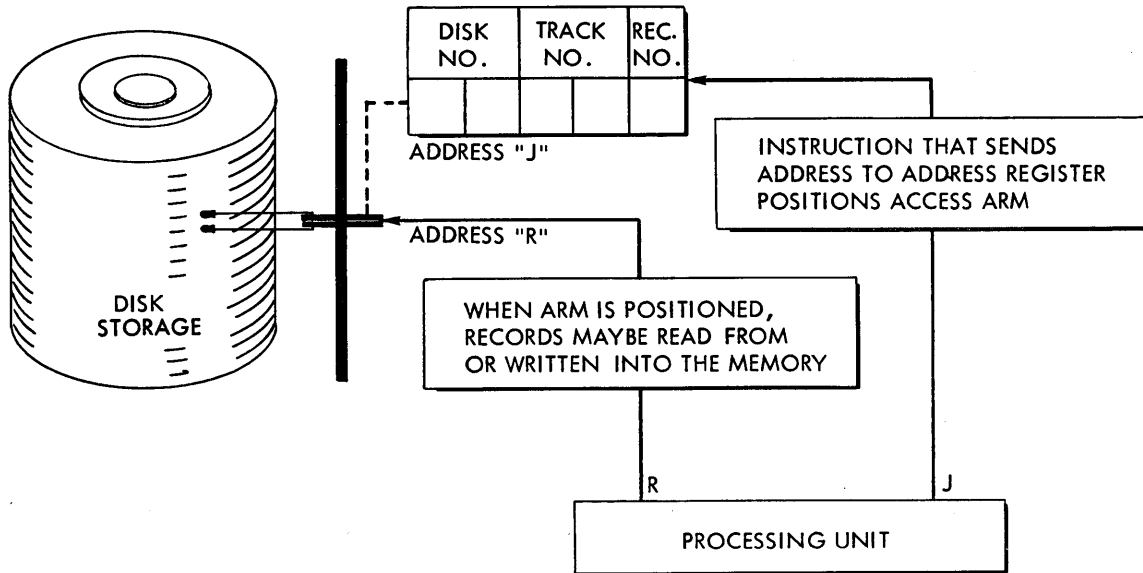

FIGURE 15. METHOD OF ADDRESSING, READING, AND WRITING IN THE DISK STORAGE

Magnetic Disk Storage

Two steps are required to read or write information in the magnetic-disk storage. First, the access arm must be moved from wherever it happens to be standing to the disk, track and sector that contains the desired record. When the access arm reaches the record, the record must be transferred through the magnetic-core unit to the process drum, if the record is to be read, or from the process drum to the disk, if the record is to be written in the disk storage (Figure 15).

Address Register

Records stored in the disk storage are located through an associated 5-position address register, that may be thought of as a "phone number" for the information. The 5-position address is arranged thus:

DISK NUMBER		TRACK NUMBER		REC. NO.
0	0	0	0	0
4	9	0 to 9	9	9

The two high-order digits specify which of the 50 disks is to be used. The disks are numbered from top to bottom with the addresses 00 to 49. The next two digits specify which of the 100 tracks on the disk is desired. The tracks are numbered 00-99 from the outside in. These four digits are used to position the access arm.

Because the arm is forked, when it is positioned on a disk and track it can read any of the ten records (five on the bottom and five on the top of the disk) that may be stored on the track. The low order digit of the address specifies which one of the 10 sectors available at that physical location is to be used. The sectors are numbered 0-4 on the top of the disk and 5-9 on the bottom. This addressing arrangement provides 50,000 sectors having addresses from 00000 to 49999. Thus, the address 12345 causes the access arm to move to disk number 12, track number 34, and read out sector number 5. Transmission of the address to the address register initiates the movement of the access arm.

The address register has the address "J" in the stored program coding structure. To move the access arm to a desired sector, the address of the sector is transferred to the address register. For example, if the address of the desired sector is recorded on the first five positions of process track W, the instruction to move the access arm to that sector is:

FROM		TO		No. Characters	Control
Track	Position	Track	Position		
W	04	J	99	05	

The transfer of the address to the address register requires 50 milliseconds. This instruction transmits the address of the desired sector to the address register and causes the access arm to start moving toward the disk, track, and sector specified by the address.

In some programs it may be desirable to address the address register with a four-digit address, but have the four digits set up in the high-order positions of the address register. This may be accomplished by having the TO address J98. For example, the number 2254 located on track W 05-08 may be sent to the address register and set up as 22540 by the instruction W 08 J 98 04.

When the access arm has moved to the desired address, the record in the sector may be transferred to any other track by the address "R." To transfer the record to the X processing track, the instruction would be:

FROM		TO		No. Characters	Control
Track	Position	Track	Position		
R	99	X	99	00	

If it is desired to transfer a record from the processing unit to the sector, the instruction is:

FROM		TO		No. Characters	Control
Track	Position	Track	Position		
X	99	R	99	00	

Note that whenever a transfer to or from the disk memory is made, the transfer of 100 characters is required. Transfers from track to track of the processing drum may specify any number of characters from 1 to 100, but transfers to and from the disk memory must specify 100 characters.

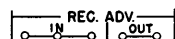

AH, 1-5

Record Advance. When successive records on the same magnetic-disk track are desired, it is not necessary to move the access arm physically. The number in the address register may be advanced, one address at a time, by control-panel wiring. A control code is attached to an instruction to cause the program to be brought to the control panel as an electrical impulse. This impulse is wired into the record

advance IN hubs to increase the number in the address register by 1. When this operation is completed, impulses are emitted from the OUT hubs; these are wired to set up the next stored program step. If the arm has previously been sent to address 12345, impulsing the IN hub will advance the address register to 12346. Successive impulses will set 12347, 12348, 12349; 12340, 12341, 12342, 12343, 12344, etc., in the address register. This makes it possible to obtain records that are spread over several sectors without the necessity of sending a new address to the address register.

Note that this operation only affects the low-order position of the address register and does not carry over into the other positions. To do so requires the relocation of the access arm; this is accomplished only by transmitting an address to the address register.

Comparing

A comparing unit is provided to allow fields from various tracks to be compared for control purposes. Comparing is controlled by placing the character "1" in the tenth position of an instruction. For example, to compare positions 00-04 of track W with positions 05-09 of track Z, the instruction

FROM		TO		No. Characters	Control
Track	Position	Track	Position		
W	04	Z	09	05	A1

does not transfer information from track W to track Z, but causes the two fields W00-04 and Z05-09 to be compared. The control code A causes the control to emerge on the control panel as an electrical impulse to test the compare selector.

On a compare instruction, during the first 10 milliseconds the instruction is read from the program track and used to set up the required paths (Figure 16). During the second 10 milliseconds, the field specified by the FROM address is read from the track into the magnetic-core unit. During the third 10 milliseconds, instead of being written on the track specified by the TO address the contents of the magnetic-core unit are sent to the comparing unit. Simultaneously, the contents of the TO address are sent to the comparing unit. The FROM and TO fields are compared bit-by-bit, character-by-character and any difference in the two fields of characters will be recognized as an unequal condition. If the two fields contain exactly the same characters, an equal condition will be indicated. When comparing a file record, the file must be used as the FROM address.

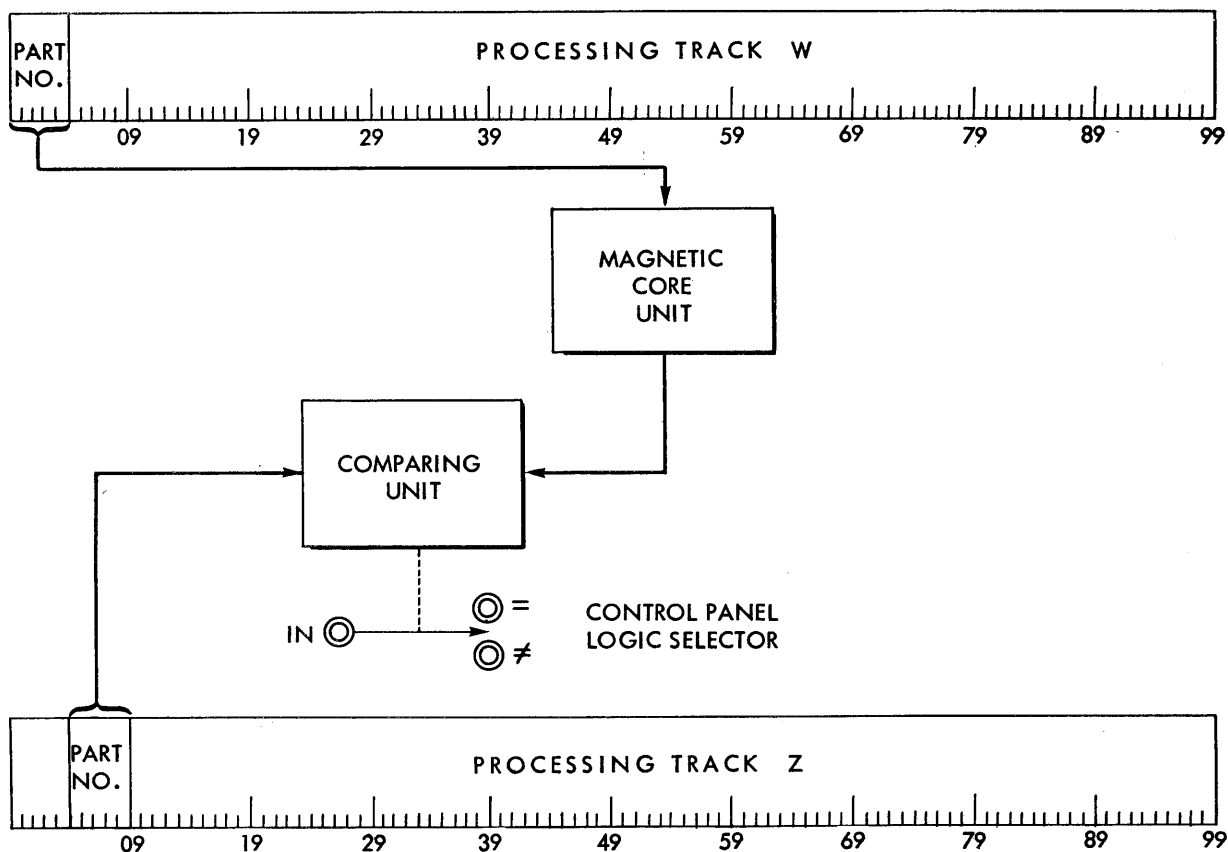

FIGURE 16. SCHEMATIC OF A COMPARING OPERATION

Compare. When two fields are compared, this selector is set to indicate the result of the comparison test. If the fields are equal, an internal path is set up between each IN hub and the = (equal) hub beneath it. If the field fails to compare, a connection is made between each IN hub and the ≠ (not-equal) hub beneath it. A PROGRAM EXIT impulse wired into the IN hub will emerge from the equal hub if the fields compare, but it will emerge from the not-equal hub if the fields fail to compare. The internal path remains set up until the next programmed compare instruction.

Field Compare

The field compare feature allows, with one instruction, from one to ten fields on the track specified by the FROM address to be individually compared with the fields of a track specified by the TO address. The FROM address of a field-compare instruction may refer to a process drum track, a disk track, or the core unit; the TO address may specify any process drum track other than the accumulator track. Neither the core unit nor the disk file may be used as a TO address.

Field comparing is controlled by placing the character 2 in the tenth position of an instruction. When this control character is read, the characters specified by the TO address are sent to the comparing unit, where they are compared bit-by-bit and character-by-

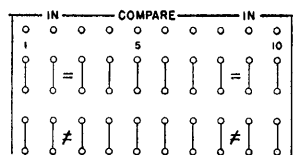

character from right to left with the characters specified by the FROM address. The results of this comparison will be indicated in the ten selectors associated with the field compare device.

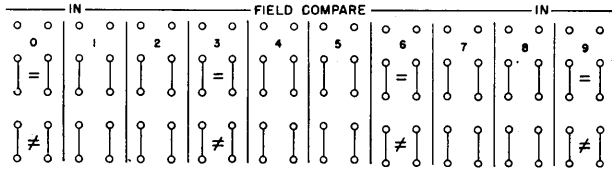

T-X, 21-40

Each selector indicates an equal or unequal condition, depending on the results of comparison of the characters in a specific 10-position field at the TO address. (Selector 0 is always controlled by positions 00-09 at the TO address; selector 1 by positions 10-19; selector 2 by positions 20-29 etc.) When a comparison is made involving any or all of the characters in one of these 10-position fields at the TO address, the corresponding selector is activated.

For example, the instruction

FROM	TO	NO. CHAR.	CONTROL
B 46	C 63	15	A 2

causes the 15 characters on track B positions 32-46 to be compared to the 15 characters on track C positions 49-63. Three field compare selectors register the results of the comparison (Figure 17). Selector 4 indicates the result of the comparison of the single digit at B 32 with the single digit at C 49; selector 5 indicates the result of the comparison of B 33-42 with C 50-59; and selector 6 indicates the result of the comparison of B 43-46 with C 60-63. Selectors 0-3 and 7-9 will retain their previous settings.

A maximum of 100 characters, divided into ten 10-position fields, may be compared on one step. When fewer than 100 characters are to be compared, the fields at the FROM address may appear in any adjacent positions on the track. In general, the fields at the TO location should be set up in adjacent 10-position segments of the track which correspond to the 10-position fields controlling the comparison selectors.

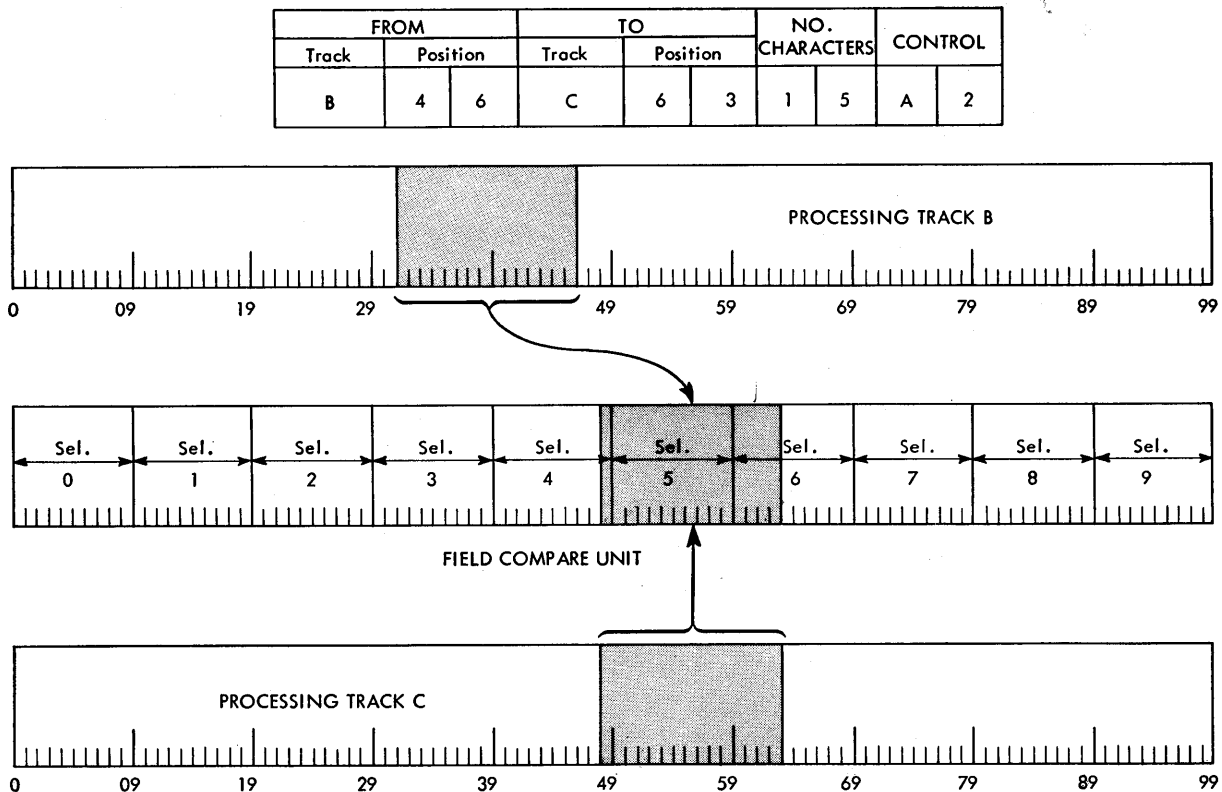
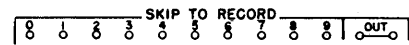

FIGURE 17. SCHEMATIC OF FIELD COMPARE OPERATION

Each field compare selector retains its setting until activated by another field compare instruction involving its controlling field. At this time, it will be reset to indicate an equal or unequal condition, depending on the result of the comparison.

Combined Compare — Code 3

If a 3 is placed in the tenth position of an instruction, both compare and field compare are activated. For example, if the instruction A 19 B 49 20 A 3 is given, both the compare selectors and the field compare selectors are set up. The control code A may then be wired to test both comparing devices. The field compare unit would register the results of the comparison in selectors three and four, and the other compare unit would register the results of the entire 20-digit comparison.



Y, 6-17

Skip-to-Record. The record skip feature is arranged with ten SKIP-TO hubs (0-9) and two common OUT hubs. When one of the numbered hubs is impulsed, the access arm remains on the same disk and track, but the disk address register is advanced so that the units position of the disk address (sector) corresponds to the number of the hub impulsed.

After the corresponding address has been set up in the address register, the OUT hub emits. This impulse is used in the same manner as a PROGRAM EXIT impulse to transfer the program to any desired step, and it must be used to restart the program. The major use for this feature will be in conjunction with the field compare unit when indexing techniques are used to locate a particular record. Indexing is explained in a later section under *Disk Storage Organization*. Figure 18 illustrates field compare and skip-to record.

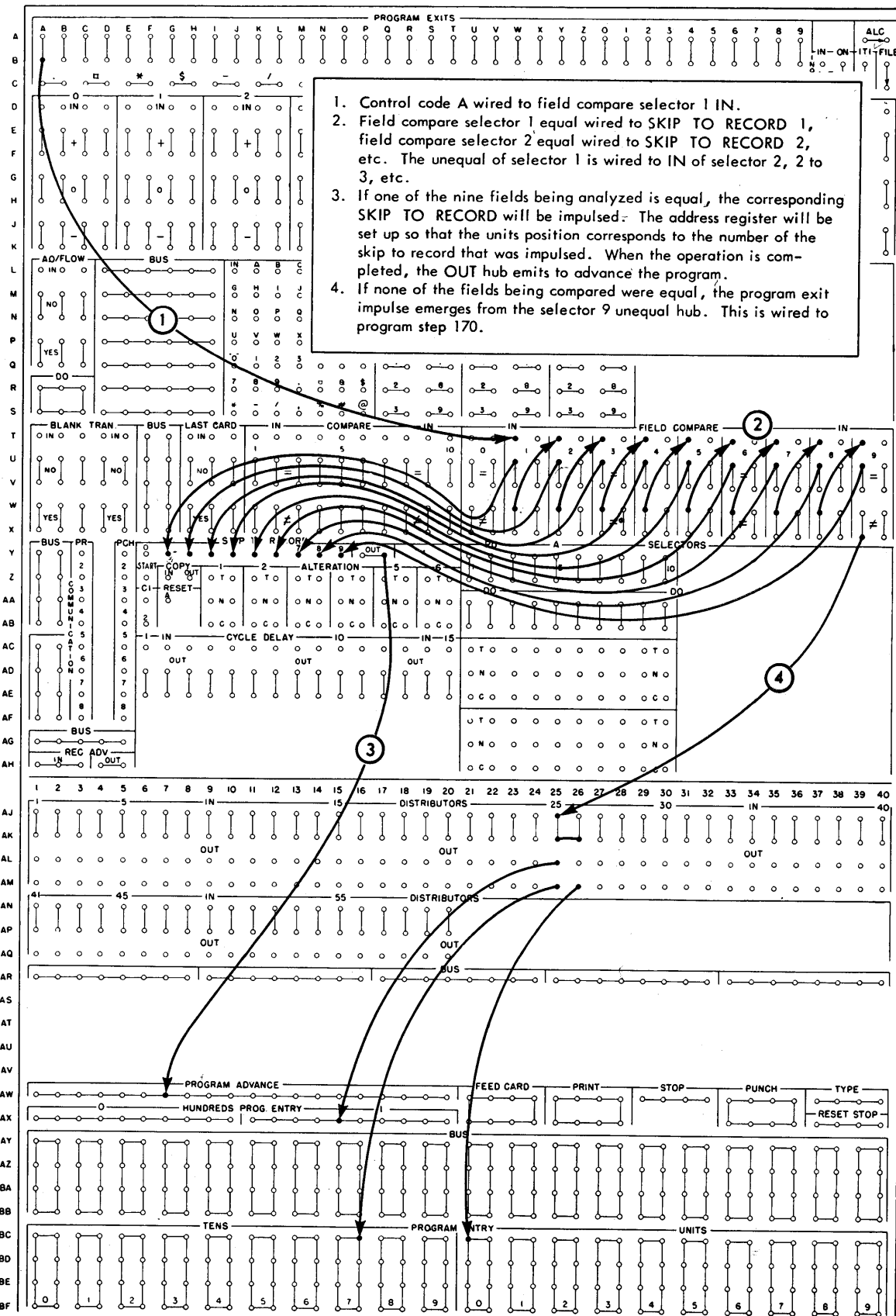

FIGURE 18. FIELD COMPARE AND SKIP-TO RECORD

LOADING THE DISK STORAGE

When the machine is first installed, the sectors of the magnetic disk unit must be loaded with the accounting records before the processing can begin. The following program is presented as a method of loading the magnetic disk storage.

It will be assumed that the memory is to be loaded with item records for an inventory of small parts. For the most direct access to the disk memory, these parts have been given part numbers between 00001 and 49999. Information pertaining to these parts is recorded on the disks in the corresponding locations. For example, the inventory record for part number 12345 is recorded at disk address 12345. (Methods of solving the addressing problems for larger numbers are presented in a later section on *Disk Storage Organization*.)

Figure 19 shows the track layout of an item record in the disk storage sector. Positions 00-79 contain the information about the part that will be loaded from input cards. Positions 80-99 contain information on usage of the part that will be accumulated as time passes. This arrangement allows the programming to be simplified, and results in faster loading of the memory, because only one card must be fed for each item.

For the purpose of checking, it will be assumed that the disk address is recorded on the first five positions of each sector. This address will be used to prove that the records are loaded on the proper sectors.

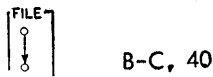

File Interlock. This interlock is provided so that new programs may be tested without changing the information on the disks. When a program has been checked out, this switch is jackplugged to allow the program to change the records in the memory. All operations except writing on the disks may be performed with this interlock unplugged.

Figure 20 diagrams the steps needed to load the memory. When the first card has been fed, recorded on the input track and checked, the START hubs emit. The wiring labeled 1 in Figure 21 starts the stored program at step 00. So that a new card may be fed immediately, the information on the input track is transferred to processing track W, and a new card is fed, checked and recorded on the input track.

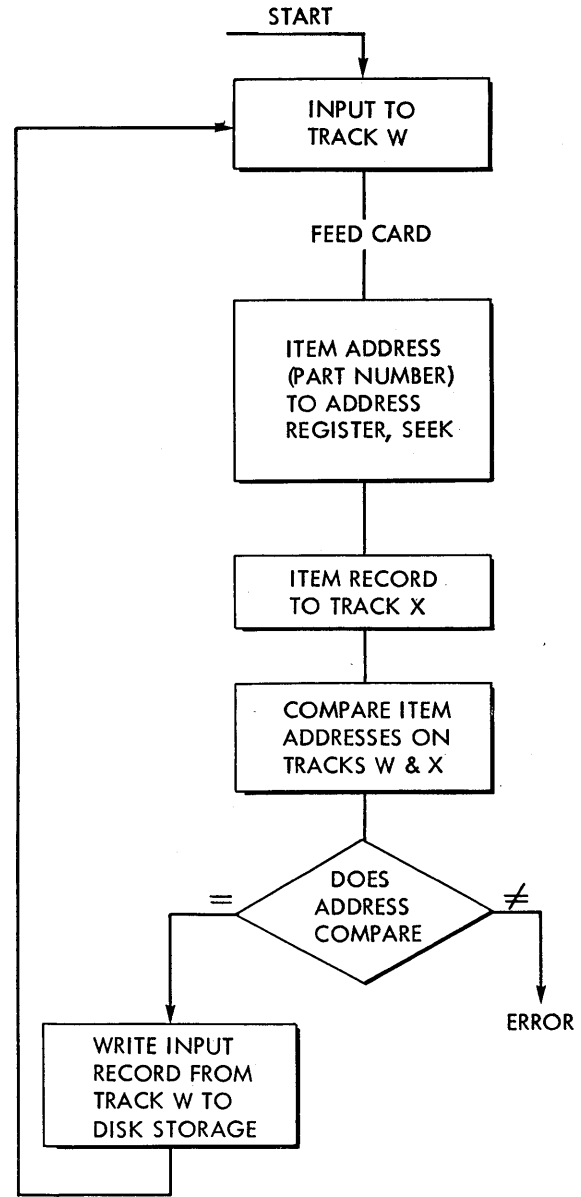

FIGURE 20. BLOCK DIAGRAM OF A DISK STORAGE LOADING PROGRAM

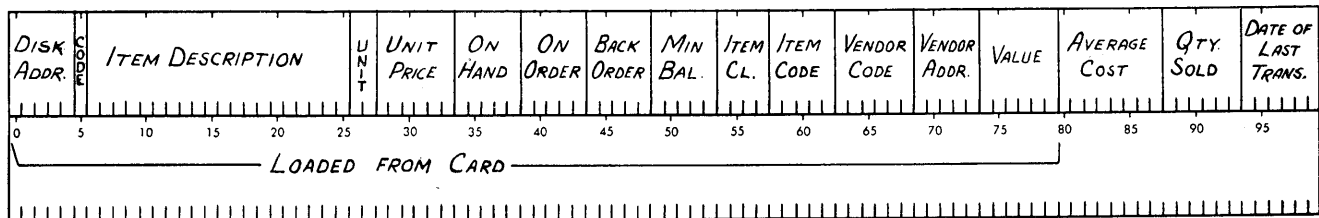

FIGURE 19. TRACK LAYOUT OF AN ITEM RECORD IN THE DISK STORAGE

The part number on the input card on track W is sent to the address register to cause the disk access arm to move to the proper location in the memory. Then the location of the arm is checked by reading the sector to processing track X and comparing the part number on the input card with

the address pre-recorded on the track. If the two addresses are equal, the input record is written into the memory, and the wiring labeled 4 in Figure 21 transfers the control back to the starting point to process the next card.

The program instructions are as follows:

Prog. Step	FROM		TO		No. Char-acters	Control
	Track	Position	Track	Position		
00	K	9 9	W	9 9	0 0	A
01	W	0 4	J	9 9	0 5	
02	R	9 9	X	9 9	0 0	
03	W	0 4	X	0 4	0 5	B 1
04	W	9 9	R	9 9	0 0	C

This instruction transfers the input track to processing track W. The control code A brings the control to the control panel, where FEED CARD and PROGRAM ADVANCE are impused,

The address (Part Number) in the first five positions of track W is sent to the address register to cause the access arm to move to the desired location.

The record at the address is brought to processing track X so that the sector address may be compared.

The item address from the input record is compared with the sector address. The control code B tests the COMPARE selector. If equal, the program continues to step 04. Otherwise, the machine stops.

If the item address and the sector address compare, the input record is written in the sector. Control code C transfers the program back to step 00.



AX, 37-40

Reset Stop. These hubs may be impulsed from a stored PROGRAM EXIT impulse when processing is to be halted. Impulsing these hubs will reset the processing unit. Place the machine in an inquiry-only mode of operation so that manual inquiries may be made. Restart by depressing the start key.

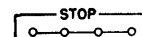

AW, 29-32

Stop. Impulsing these hubs will stop the program. Operation may be restarted by depressing the program start key on the 380 Console.

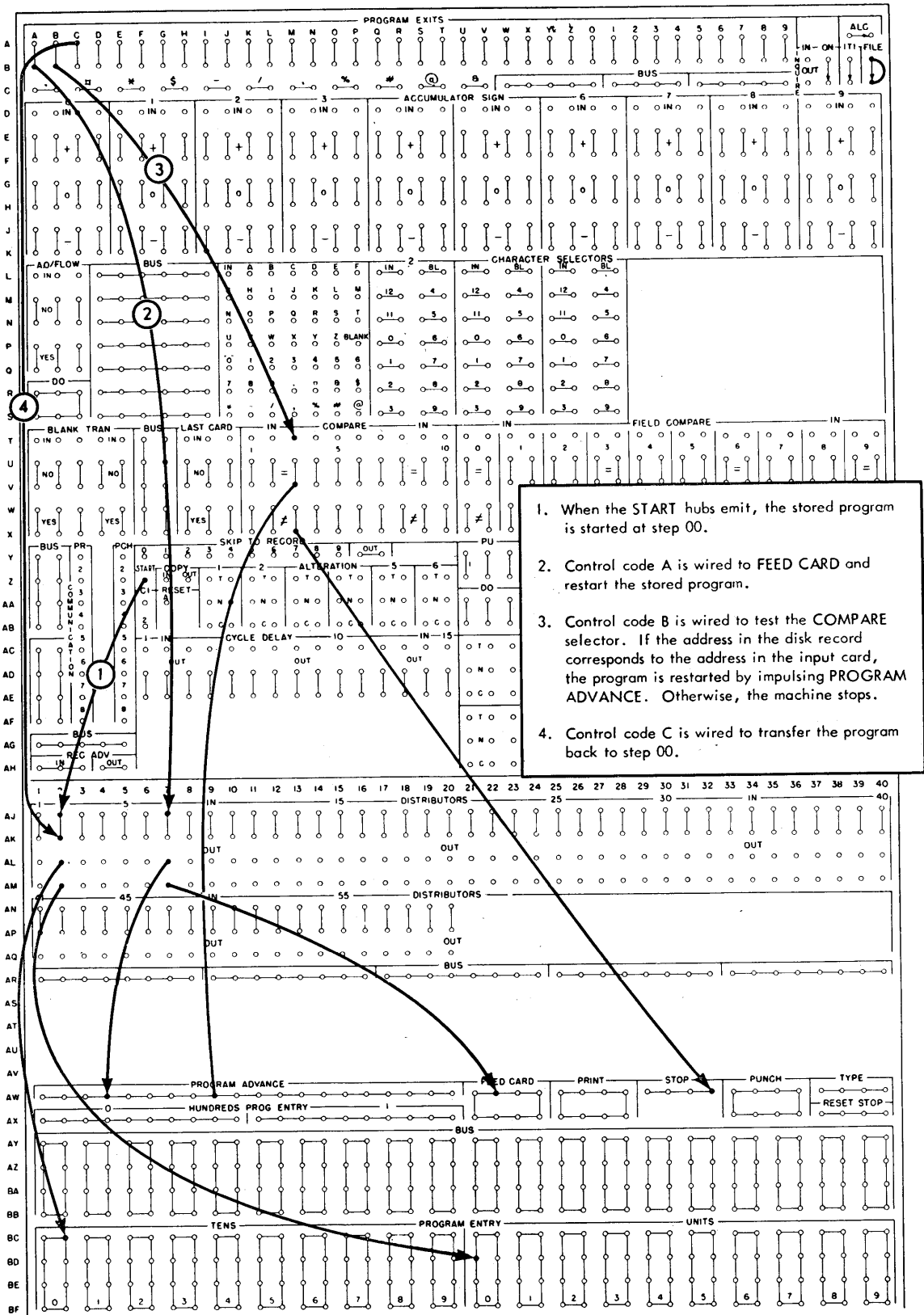

1. When the START hubs emit, the stored program is started at step 00.
2. Control code A is wired to FEED CARD and restart the stored program.
3. Control code B is wired to test the COMPARE selector. If the address in the disk record corresponds to the address in the input card, the program is restarted by impulsing PROGRAM ADVANCE. Otherwise, the machine stops.
4. Control code C is wired to transfer the program back to step 00.

FIGURE 21. CONTROL PANEL WIRING FOR LOADING THE MEMORY

UNLOADING THE DISK STORAGE

AT REGULAR intervals, it may be desirable to print out sections of the memory for a permanent record. The records may be read out in numerical sequence by the use of arithmetic, as described later. Another method, that allows the records to be printed out in any order desired, is to have a deck of cards with the memory addresses punched in them, one to a card, along with other pertinent codes. These cards may be arranged in any order desired; then when they are placed in the card reader and fed into the machine they may cause the memory to be read out and printed in that order.

Figure 22 diagrams the steps for this method of unloading the memory. The part number from the input track is used to cause the access arm to locate the record in the disk memory. The record is transferred to processing track X, and the address is compared to prove the access arm reached the desired record. If the proper record has been obtained, it is transferred to the output track and printed. Note that two print cycles are required if the entire 100 characters are to be printed. The control is transferred to the starting point to process the next card, as shown in the wiring diagram of Figure 21.

The program steps for this operation are shown on the following page.

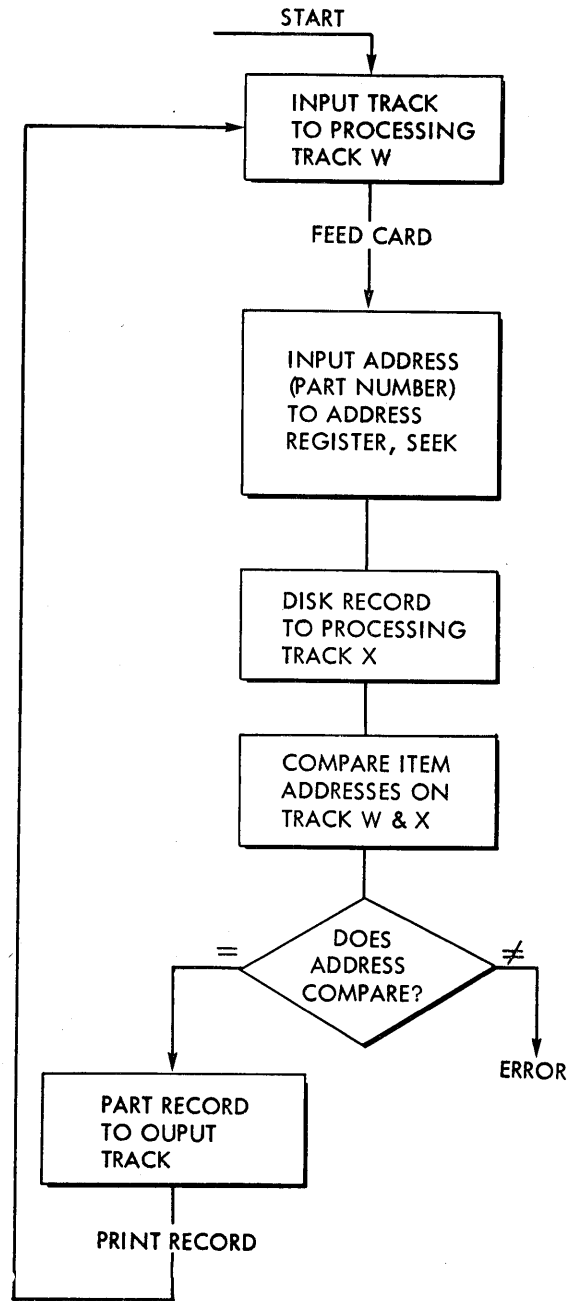

FIGURE 22. BLOCK DIAGRAM OF A DISK STORAGE-UNLOADING PROGRAM

Prog. Step	FROM		TO		No. Characters	Control	
	Track	Position	Track	Position			
00	K	9 9	W	9 9	0 0	A	
01	W	0 4	J	9 9	0 5		
02	R	9 9	X	9 9	0 0		
03	W	0 4	X	0 4	0 5	B 1	
04	X	9 9	S	9 9	0 0	C	

When the start hubs emit, the stored program is started at step 00. This step transfers the contents of the input track to processing track W. Control code A causes another card to feed.

The item address is sent to the address register to cause the access arm to move to the desired record.

The disk record is brought to processing track X so the recorded address can be checked to insure that the access arm is positioned properly.

The item address on the disk record and the item address on the input card are checked by the comparing unit. If they agree, the program proceeds to step 04; otherwise, the machine stops.

The part record is transferred to the output track, and the control code is wired to cause the printer to print the record, and skip the program to step 00.

ARITHMETIC OPERATIONS

Accumulators

One track on the magnetic drum in the processing unit is designed for accumulation. The track is divided into ten sections of ten positions each. Each of these sections is a separate accumulator. The positions of the accumulators are addressed in the same manner as the positions of any other track. The layout of the accumulator track is shown in Figure 23.

The maximum field that may be entered into one accumulator on any one transfer is ten digits. It is not possible to couple the accumulators in the manner that accounting machine counters are coupled. If an accumulated amount exceeds the 10 positions of the accumulator, the accumulator overflow selector is transferred on the control panel and the accumulator overflow light at the supervisory station is turned on. Depending on the wishes of the programmer, the machine may be caused to stop automatically, or to take corrective action.

Two or more adjacent fields of information may be entered into a similar number of adjacent accumulators on one program step. Normally, the low-order positions of the succeeding fields must be separated by ten positions to agree with the low-order positions of the accumulators.

The accumulator track is addressed by the stored program characters L and M, as follows:

	<u>FROM TRACK</u>	<u>TO TRACK</u>
Accumulator add		L
Accumulator subtract		M
Accumulator read out	L	
Read out and reset	M	

Examples: To add the six-digit number located in positions 54-59 of track W into accumulator 2, the instruction is:

FROM		TO		No. Characters	Control
Track	Position	Track	Position		
W	5 9	L	2 9	0 6	

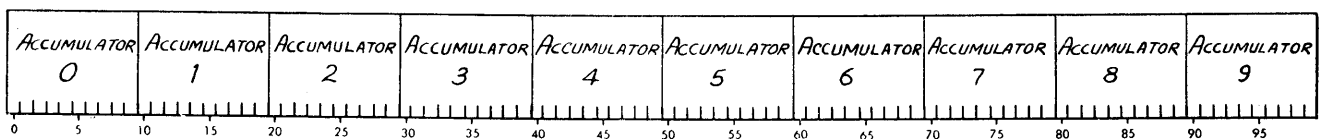

FIGURE 23. LAYOUT OF THE ACCUMULATOR TRACK

To subtract the three-digit number located in positions 13-15 of track X into the same accumulator, but shifted to the left two places, the instruction is:

FROM		TO		No. Characters	Control
Track	Position	Track	Position		
X	15	M	27	03	

This arrangement allows records to be entered with shifting to align the decimal points.

Reset — Add, Reset — Subtract

The accumulators may be caused to reset and then add or subtract on a single cycle by placing a 5 in the tenth position of the instruction. For example, to reset accumulator 8 and then add the quantity standing in positions 51-55 of track W, the instruction would be:

FROM		TO		No. Characters	Control
Track	Position	Track	Position		
W	55	L	89	05	5

To reset the accumulator and subtract the same quantity, the instruction would be

FROM		TO		No. Characters	Control
Track	Position	Track	Position		
W	55	M	89	05	5

Readout

Readout from the accumulator is the same as a normal transfer operation. To read out the difference developed in accumulator 2 by the instructions in the examples just shown, transferring the answer to positions 60-65 of track W, the instruction would be:

FROM		TO		No. Characters	Control
Track	Position	Track	Position		
L	29	W	65	06	

After the instruction is completed the result remains in the accumulator.

Read Out and Reset

To read out the difference in accumulator 2 and reset the accumulator, the instruction is:

FROM		TO		No. Characters	Control
Track	Position	Track	Position		
M	29	W	65	06	

When two or more accumulators are read out and reset on the same instruction, all accumulator positions of the affected accumulators are reset. For example, the instruction

FROM		TO		No. Characters	Control
Track	Position	Track	Position		
M	54	Y	72	10	

reads out the five high-order positions of accumulator 5 and the five low-order positions of accumulator 4, transferring these two fields to track Y. Although only five digits are read from each of them, both accumulators will have all 10 positions restored to zero. Figure 24 illustrates the effect of this instruction on the accumulators.

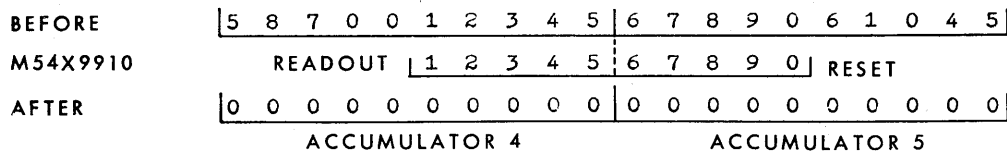

FIGURE 24. EFFECT OF READOUT-RESET INSTRUCTION ON THE ACCUMULATORS

Sign Control

For algebraic addition and subtraction, sign control is maintained by overpunching the low-order position of each negative field with an 11 (X) punch. The negative low-order positions thus stand on the processing tracks as alphabetic characters; for example, the amount -12.45 stands on track W as 124N. When this field is transmitted to the accumulator, the N is sent first, and then the 4, etc. If the instruction requires that this amount be added into the accumulator, the negative overpunch will cause the true amount, 1245, to be subtracted. If the instruction requires that this amount be subtracted into the accumulator, the presence of the negative overpunch will condition the accumulator to add the amount, thus maintaining the algebraic sign control.

When more than one field is transmitted to the accumulators on a single instruction, the machine looks for a sign overpunch on the first character transmitted. This low-order digit need not be read into the units position of the accumulator. The add-subtract controls are conditioned by the sign of the operation and the sign of the transmitted number. The machine looks for a sign overpunch at each incoming position that enters the low-order position of each subsequent accumulator, and reconditions the add-subtract controls accordingly. Figure 25 shows the effect of a transfer of this type of the accumulators. Although the negative numbers stand on the accumulator track as ten's complements, only true figures are read out.

When a negative accumulator is read out, the sign overpunch is automatically attached to the first digit read out of the accumulator, regardless of its position.

The coding of the 12-Zone (X and 0 bits) causes the machine to recognize a 12-overpunch as a negative sign.

Only the numerical portions of the characters sent to the accumulator track are retained. The signs as-

sociated with each of the 10 accumulators are available on the accumulator sign selectors on the control panel.

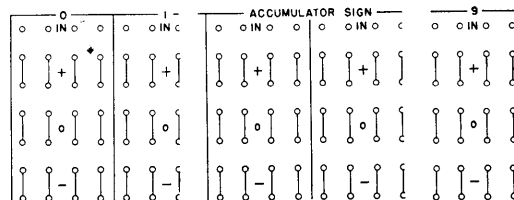

D-K, 1-40

Accumulator Sign. Each accumulator has an associated selector that shows its sign. By using a PROGRAM EXIT impulse, the sign selector may be tested to determine if the accumulator is positive, stands at zero, or has a negative balance. A test impulse, wired into the IN hub, emerges from the + hub if the accumulator is positive, from the 0 hub if the accumulator is zero, and from the - hub if the accumulator is negative.

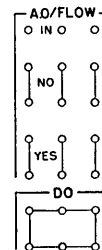

L-S, 1-3

Overflow. If an accumulated amount overflows an accumulator, the accumulator overflow selector is transferred and the overflow light at the console is turned on. The overflow selector is a latch-type selector; once transferred it remains in that condition until impulsed to dropout on the control panel. The programmer may make use of this selector to stop the machine if an overflow occurs, by wiring a PROGRAM EXIT impulse into the IN hub, and from the NO hub to the following program step. If an overflow occurs, the following step will not be set up, and the machine will stop. This practice is recommended where there is a possibility that the capacity of an accumulator may be exceeded.

TRACK X	9 0	X	9 9
	1 2 3 4 5	1 2 3 4 5	1 2 3 4 5
BEFORE	0 0 0 0 0 0 0 0 0 0	0 0 0 0 0 0 0 0 0 0	0 0 0 0 0 0 0 0 0 0
X99L5410	ADD 1 2 3 4 5	1 2 3 4 5	
AFTER	9 9 9 9 9 8 7 6 5 5	1 2 3 4 5 0 0 0 0 0	0 0 0 0 0 0 0 0 0 0
	ACCUMULATOR 4	ACCUMULATOR 5	

FIGURE 25. EFFECT OF SIGN CONTROL OVERPUNCH ON THE ACCUMULATORS

AVAILABILITY EDITING

FIGURE 26 shows the elements of an availability edit, in which the machine is programmed to look up the item record of any item ordered and determine whether the order can be filled from available stock.

The sectors of the disk memory have been loaded with the item records, the part numbers being arranged for direct addressing. Thus, part number 12345 has its item record stored at memory location 12345, etc. The item records

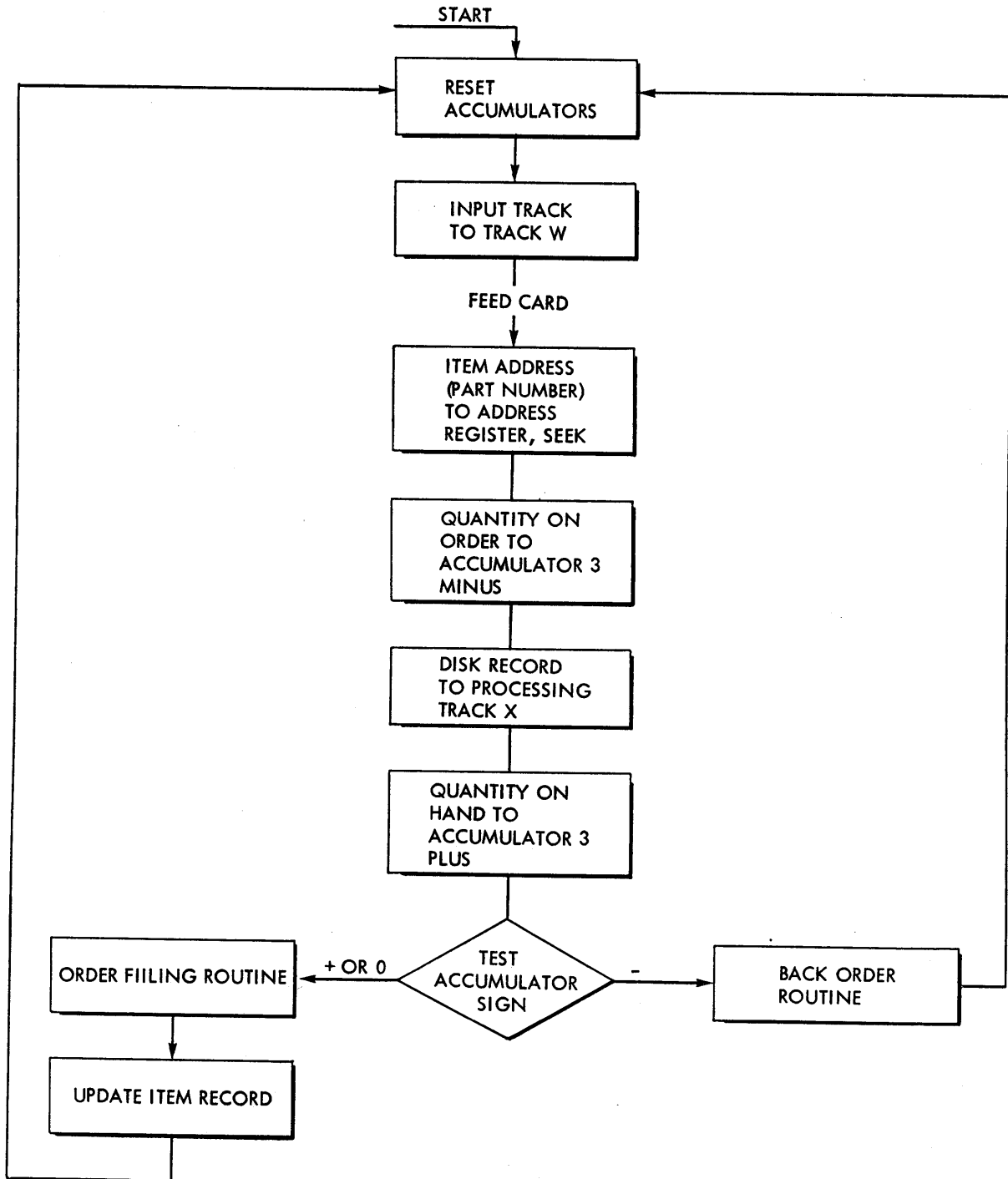

FIGURE 26. BLOCK DIAGRAM — AVAILABILITY EDIT

CARD TRACK OR RECORD		PART NO	DESCRIPTION	QTY ON HAND	QTY ON ORDER	QTY BACK ORDER	MIN BAL	MAX BAL	VALUE	UNIT COST	UNIT PRICE	
PART RECORD TO TRACK X												
INPUT CARD TRACK W		CUST No.	ITEM ORDERED PART No.	QTY								

FIGURE 27. TRACK LAYOUT DIAGRAM — AVAILABILITY EDIT

are arranged as shown in Figure 27. Each item record carries the number of parts on hand in columns 26-34.

The second track diagram in Figure 27 shows the arrangement of the input order card. This card contains the customer number, the part number being ordered, and the number of parts desired.

From the input card, the part number is used to address the disk memory to find the item record for the part. The quantity on order is subtracted into accumulator 3, then, when the item record has been found, the quantity on hand is added into accumulator 3. Now the accumulator sign selector is tested; if + or 0, the order can be filled, so the program branches to the series of instructions that result in filling the order and writing an invoice. These

steps will not be discussed at this time. Then the record is updated by writing the remaining quantity of parts on hand into the proper positions of the item record and returning the record to the disk memory. In this way, the disk records constantly show the current quantity on hand.

If, when the accumulator is tested, a negative balance is discovered, the order cannot be filled completely, so the program is branched to a series of instructions that result in setting up a back order. These steps will not be discussed at this time. When the order has been completed, the program is transferred to the starting point so that the next item can be processed. Figure 28 shows the control-panel wiring for this program.

Prog. Step	FROM		TO		No. Characters	Control
	Track	Position	Track	Position		
00	M	9 9			0 0	
01	K	9 9	W	9 9	0 0	A
02	W	0 9	J	9 9	0 5	
03	W	1 3	M	3 9	0 4	
04	R	9 9	X	9 9	0 0	
05	X	3 4	L	3 9	0 9	B

When the START hubs emit, the stored program is started at this step. The accumulators are reset by this instruction.

This instruction transfers track K, the input track, to processing track W. The Control code is wired to feed another card.

This instruction transfers the item address to the address register to cause the access arm to move to the item record.

The quantity of parts ordered is subtracted into accumulator 3.

The item record is transferred from the disk memory to track X.

The quantity of parts on hand is added into accumulator 3. Then the control code is emitted from the program exit B hub and wired to test accumulator 3. If the accumulator is negative, there is not enough stock to make shipment, so the program advances to step 06 to cause the order to be back-ordered. If the accumulator is positive or zero, the program is skipped to step 20, to a series of program steps that fill the order, write the invoice, and update the item record. The method of performing these operations will be shown in a later program.

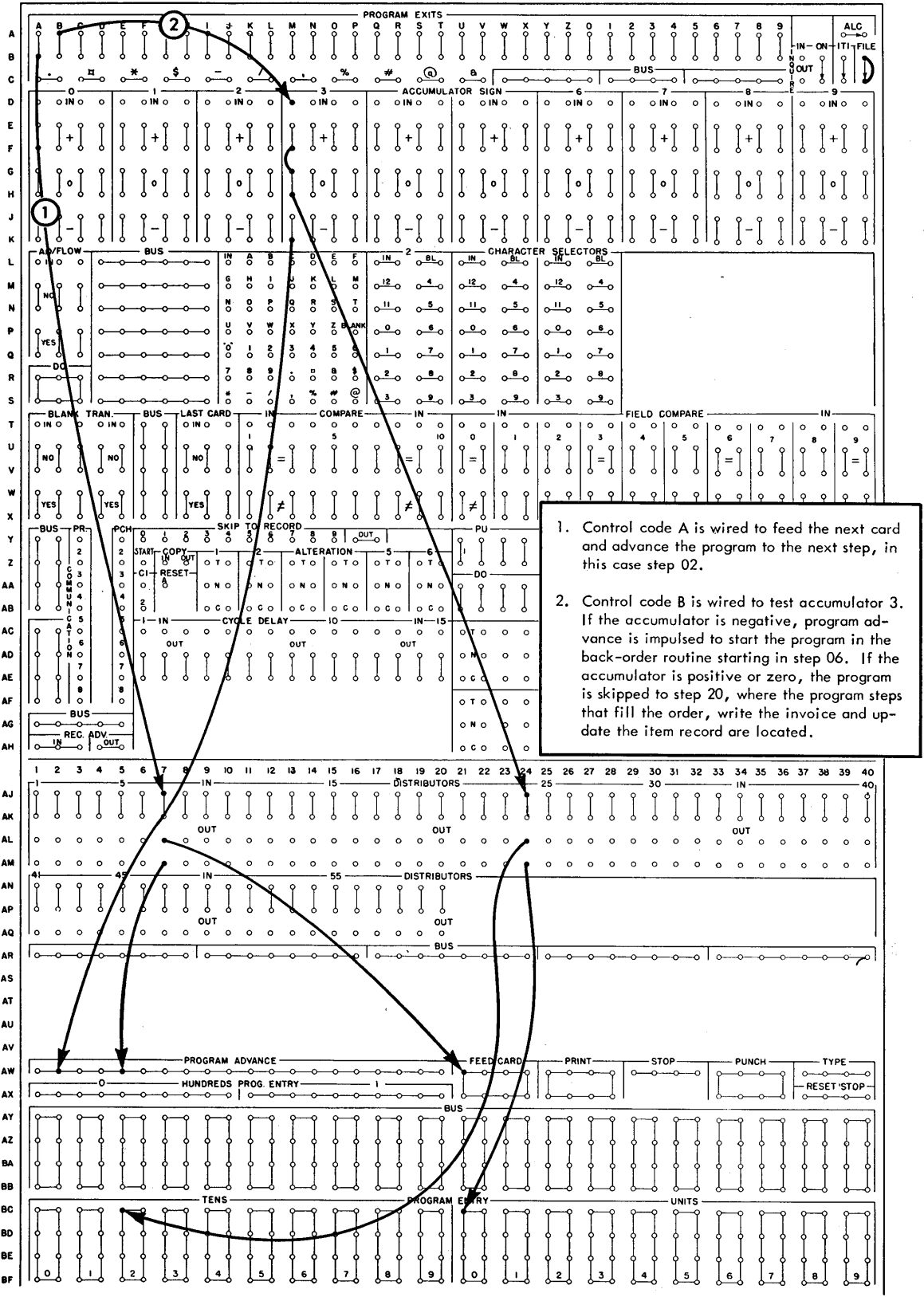

1. Control code A is wired to feed the next card and advance the program to the next step, in this case step 02.
2. Control code B is wired to test accumulator 3. If the accumulator is negative, program advance is impulsed to start the program in the back-order routine starting in step 06. If the accumulator is positive or zero, the program is skipped to step 20, where the program steps that fill the order, write the invoice and update the item record are located.

FIGURE 28. CONTROL PANEL WIRING — AVAILABILITY EDIT

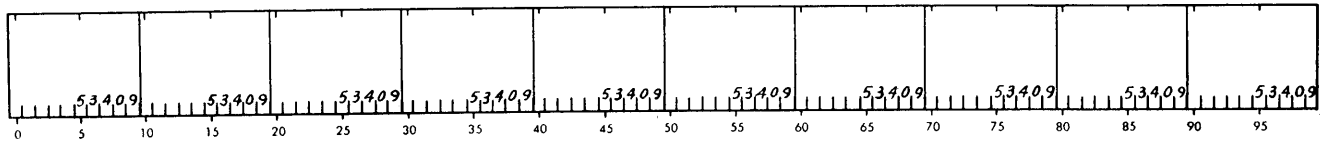

FIGURE 29. LAYOUT OF THE MULTIPLICAND TRACK

Multiplication

Programming a multiplication is a two-step operation. First, the multiplicand must be loaded on the multiplicand track in the processing unit by a normal transfer instruction. The maximum-length multiplicand that may be used for multiplication is 9 digits, so the number-of-characters part of the instruction must always be coded 09 or less. Ten digits may be loaded for programmed addressing as described later.

The second step is to move the multiplier into the magnetic-core unit and perform the actual multiplication as described below. The product is developed in accumulators 0 and 1; therefore these accumulators should not contain any information needed later. These accumulators should normally be reset before a multiplication is programmed. The multiplier may be as large as desired; however, the maximum size of the product is 20 digits, obtained when the multiplicand contains 9 digits. If the multiplier is greater than 11 digits, the least significant positions of the product will be dropped unless the multiplicand is positioned at the left or high-order positions of each multiplicand track field.

Assume that it is desired to multiply the 9-digit number in positions 82-90 of track W by the 11-digit number in positions 71-81 of track Z. The multiplicand is loaded by transferring positions 82-90 of track W to the multiplicand track, using the TO address V.

FROM		TO		No. Characters	Control
Track	Position	Track	Position		
W	90	V	99	09	

Loading the multiplicand is a normal 30-millisecond transfer operation. The transmitted multiplicand is written around the multiplicand track 10 times, cor-

responding to the 10 accumulator fields. The multiplicand is always written in the low-order positions of each field of 10 characters, and the remainder of the field is reset to blank. Any character transmitted to the multiplicand track is carried in full; zones and sign marks remain on the multiplicand track but are not used in the multiplication. A single multiplicand may be carried through several multiplications for group multiplication (Figure 29).

The actual multiplication begins when the machine receives an instruction with the TO address N. The transmitted multiplier is automatically sent to the magnetic-core unit. Under the control of successive multiplier digits, the multiplicand is read out and added into accumulator 0. Each digit of the multiplier is processed in one drum revolution (10 milliseconds).

During each 10-millisecond cycle, the partial product previously developed is shifted one place to the right in accumulators 0 and 1, and the multiplicand is added into accumulator 0 the number of times specified by the multiplier digit. During these operations all sign control is inactive, and the product is always positive.

The product is developed in accumulators 0 and 1. If this product results from a 1-digit multiplier, the product will be entirely in accumulator 0. For each additional multiplier digit programmed, the low-order digit of the product is shifted one position into accumulator 1. The total number of multiplier digits programmed is specified by the number-of-characters part of the program step that starts multiplication:

FROM		TO		No. Characters	Control
Track	Position	Track	Position		
Z	81	N	99	11	

SAMPLE MULTIPLICATION WITH HALF-ADJUSTMENT

8163.29 X 534.19 4.360.747.8851
5 Half-adjustment
4.360.747.89

INSTRUCTION	OPERATION	PARTIAL PRODUCT	ACCUMULATORS	START	TIME MILLISECONDS
				END	
M11 W50 09	Reset Accums. 0 and 1		0000000000	0000000000	(30)
Z05 L07 01	Emit 5 for half-adjustment		0000000500	0000000000	30
W90 V99 06	Load 6-digit multiplicand		0000000500	0000000000	30
W84 N99 05	Load 5 digit multiplier, multiply X 9	0007346961	0000000050 0007347011	0000000000 0000000000	30
	Multiply X 1	0000816329	0000734701 0001551030	1000000000 1000000000	10
	Multiply X 4	0003265316	0000155103 0003420419	0100000000 0100000000	10
	Multiply X 3	0002448987	0000342041 0002791028	9010000000 9010000000	10
	Multiply X 5	0004081645	0000279102 0004360747	8901000000 8901000000	10
M11 W50 09	RO Product Reset Accums.		0004360747 0000000000	8901000000 0000000000	30

NOTE: The first and last instructions are the same. If accumulators 0 and 1 are used only for multiplication, the last instruction accomplishes reset before the following multiplication, so the time for the first instruction need not be counted. For this reason, the 30 milliseconds is shown in parentheses. The 5 used for half-adjustment is recorded at Z 05, to be read whenever a 5 is needed.

FIGURE 30. METHOD OF MULTIPLICATION

If there should be more than 11 multiplier digits programmed, the excess low-order digits of the product will be lost by shifting out of the low-order position of accumulator 1 unless the multiplicand is positioned at the left or high-order positions of each multiplicand track field. For example, 15 digits can be multiplied by five digits if the five digits representing the multiplicand are loaded on the multiplicand track so that each field contains five zeros in the low-order positions.

The position of the low-order digit of the product in accumulator 1 is given by the formula:

$$\begin{aligned} &\text{no. of digits in multiplier including high-order zeros} \\ &+ 8 = \text{address of low-order position of product.} \end{aligned}$$

For example, when the multiplier is four digits, the address of the low-order product digit is L (or M) 12.

Half-Adjustment

When decimals are dropped from a product, it may be necessary to correct the number that is retained

to the nearest remaining decimal value. For example, to retain two decimal places from the product 12.7945, the value is 12.79; but from the product 12.7954 the value is 12.80. The last decimal retained in a multiplication may be half adjusted by adding a 5 into the highest-order position dropped. In this example, the 5 is added into the thousandths decimal position. When the product is 12.7945, adding the 5 raises it to 12.7995, and the last two decimal places are dropped, leaving 12.79. When the product is 12.7954, adding the 5 raises it to 12.8004, and when the last two decimal places are dropped, 12.80 is left. The method of programming a half-adjustment is shown in the example of Figure 30, which also shows how the product is built up through repetitive adding into accumulators 0 and 1.

For half adjustment, note that the 5 is placed in accumulator 0 one position higher than the number of places to be dropped. Because the accumulators shift to the right before the first multiplication occurs, the 5 is shifted to the correct position before the first partial product is added.

Programmed Division

Direct division is not available as an automatic machine function; however, division may be readily programmed. Three approaches that may be used are multiplying by reciprocals, trial divisor, and successive subtraction. The last method is presented here.

In this routine, the divisor is subtracted from the dividend in successive steps starting with the high-order position of the dividend. Each subtraction cycle is counted to develop the quotient, and the accumulator is tested for a minus condition. When the accumulator turns minus, the divisor is added back to the dividend one time, and the quotient count is corrected. The remainder and quotient are then shifted one column to the left, and the routine is continued.

A blank track (30 positions) is required to carry the divisor, quotient count (-1), and a constant (1) which is referred to as a housekeeping count. These factors can be entered on this track from an emitter track in positions corresponding to the accumulator track where they will be used. The high-order position of the divisor is in position 1 of the blank track, the quotient count (-1) in position 29, and the housekeeping count (1) in position 30. NOTE: The last two items are shown as being set up during the division routine; however, they could be established during the original program loading. This would eliminate these two steps on each division operation.

The dividend may be up to 19 digits. It is added into accumulators 0-1 with the high-order position shifted left as far as possible based on the application. This location is dependent on the size of the divisor, as well as the quotient to be developed. In the simplest situation, a 4-digit divisor (in positions 1-4) would require that the high-order position of the dividend be entered in position 5 of accumulator 0. This provides for a divisor of 0001 and prevents division by zero.

Using the preceding rule for locating the dividend

may, in many actual cases, cause a waste of process time. For example, to divide total earnings by hours worked to determine actual hourly rate on a payroll application, the maximum hours (divisor) may never exceed 110.00, and the maximum earnings (dividend) may never exceed 999.99. If, however, past experience shows that the hourly rate never exceeds 12.75 (four digits), strict adherence to this rule would waste processing cycles, because the maximum quotient would be developed as 00012.75. In this situation, therefore, the dividend should overlap the divisor by three digits to save excess cycles. This requires that the dividend be entered in accumulator 0-1 with the high-order position located in position three.

The following rule has, therefore, been developed to determine the location of the dividend to meet the requirements of a specific application. NOTE: The numbers illustrate the preceding hourly rate situation:

Digits to left of decimal in divisor plus 1	4
Add maximum number of possible digits to left of decimal in quotient	2
	—
	6
Subtract digits to left of decimal in dividend	-3
	—
Enter high order position of dividend in position	3

Accumulator 2 develops the quotient in the low order positions. Accumulator 3 is used for housekeeping (to count the number of positions in the quotient and the divide routine). The difference between 9 and the number of quotient digits (9's complement) is entered in the high-order position of the accumulator. An accumulator overflow signals the end-of-divide routine.

Figure 31 shows the track arrangement for a division problem. The factors on track Z are aligned to provide for simultaneous addition and subtraction in the accumulators.

The program for division by successive subtraction is illustrated in Figure 32.

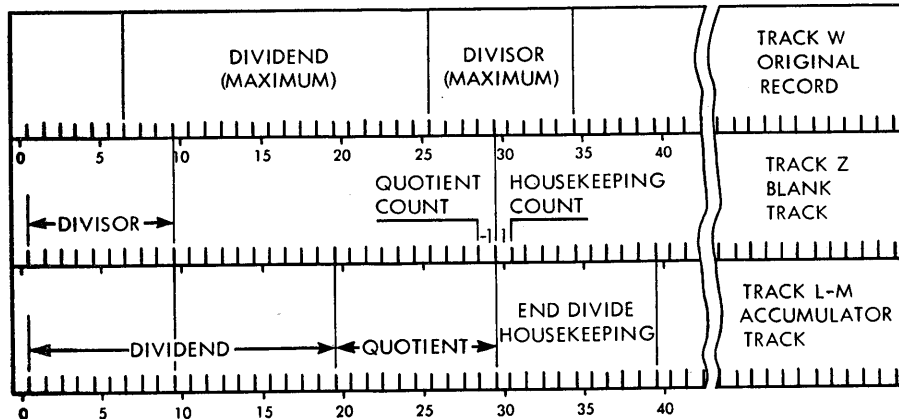

FIGURE 31. DIVISION BY SUCCESSIVE SUBTRACTION

Prog Step	From		To		No Characters	Control
	Track	Position	Track	Position		
00	W	25	L	*19	*19	
01	W	34	Z	*09	*09	
02	X	*21	Z	29	01	
03	X	*39	Z	30	01	
04	X	*41	L	30	01	
05	Z	29	M	29	29	A
06	Z	30	L	30	30	B
07	M	29	L	28	29	
08	Z	29	M	29	29	C

NOTE: * These items vary with application.

FIGURE 32. DIVISION BY SUCCESSIVE SUBTRACTION (PROGRAM)

I. SET-UP ROUTINE

Add dividend in accumulator 0-1 in proper position according to rule.

Transfer divisor to working storage track (Z) with high-order position to correspond with position 1 of accumulator 0.

Set up quotient count as a -1 on working track (Z) so that it will correspond with the low-order position of accumulator 2. Note that when the divisor is subtracted from the dividend in later steps, the quotient count is subtracted (added) as a - (-1) in accumulator 2. Track X is a constant or legend track used for setting up track Z.

Set up the housekeeping count by emitting a "1" onto storage track Z adjacent to quotient count so that it can be added into the high-order position of accumulator 3 on the restore cycle as described later.

Add a factor in the high-order position of accumulator 3 of 9 minus the number of quotient digits desired. The housekeeping count is added to this figure on each restore cycle, and the accumulator overflow selector on the control panel can be used to signal the end of divide routine.

Subtract divisor from accumulator 0 and subtract (add) the quotient count to accumulator 2. Test accumulator 0 on the control panel to see that factors are correct. If accumulator 0 is plus or zero, this indicates improper factors such as 0000 divisor, and the program should be stopped to indicate an impossible condition to the operator. If accumulator 0 is minus, proceed to the basic loop of the routine in step 06.

II. RESTORE--TEST FOR END--SHIFT

Restore cycle. Add the divisor back to the dividend to restore accumulator 0 to plus. Add (subtract) quotient count to restore the over count of the previous step. Add housekeeping counting to accumulator 3. Test the overflow selector on the control panel. If an overflow exists (which will occur only on the succeeding passes through this loop), it signals the end of divide routine for return to the regular program. If no overflow, continue through basic loop on step 07.

Shift dividend or remainder and quotient one column to left in accumulators 0-1-2.

III. SUCCESSIVE SUBTRACTION

Subtract divisor from dividend and subtract (add) quotient count in accumulator 2. Test accumulator 0 on control panel. If plus or zero, repeat step 8. When accumulator 0 is minus, return to step 06 to restore the over-subtraction and the quotient count, and adjust the housekeeping count. Steps 06 through 08 are repeated until the end of the routine, and step 08 is repeated within this basic loop as many cycles as are required.

OTHER LOGIC ELEMENTS

Character Selector. The character selector provides a way of analyzing any character on any drum track as a basis of control. This allows the character in a single control column to bring about multiple decisions. The character

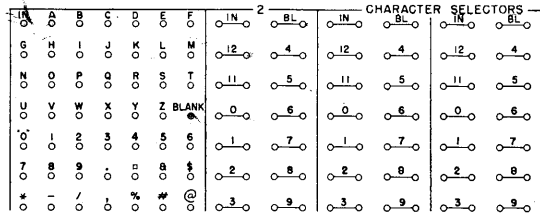

L-S, 10-28

to be entered into the character selector is sent to this unit by an instruction with the hyphen (-) code as the TO address. For example, to enter the control code recorded in position 05 of processing track W into the character selector, the instruction is:

FROM		TO		No Char-acters	Control
Track	Position	Track	Position		
W	05	-	99	01	B

Any character thus entered establishes test paths between each IN hub and the exit hubs corresponding to the character entered. On the basic machine, four distinct paths are set up. Three of these paths are arranged so that a PROGRAM EXIT impulse entered into the IN hub emerges from the hubs corresponding to the IBM card code of the character being tested. For example, if an A code is entered in the unit, a PROGRAM EXIT impulse wired into any one of these IN hubs would emerge from the 12 and the 1 hubs under that IN hub. Special characters emit zone and upper punch only; for example, the character * (X, 4, 8) emits X and 4.

In the fourth path, a test impulse wired into the IN hub emerges from only one of the 48 exit hubs representing the specific letters, numbers and special characters. The paths remain set up until another character is addressed to the unit,

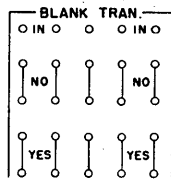

T-X, 1-5

Blank Transmission. Every transfer of information in the machine is monitored by the blank field device to allow

the control to determine if significant information is transferred. A path is established between each IN hub and the NO hub beneath it if the field is not blank or zero. Otherwise, the path is established between the IN hub and the YES hub. This happens when the instruction transfers only zeros and coded blanks. This device is very useful in the spread-card operation to be discussed later, where it is used to give an indication whenever the programming has completed the processing of the last recorded field. *The selector must be tested immediately*, using a PROGRAM EXIT impulse, because the next instruction sets up a new reading in the indicator.

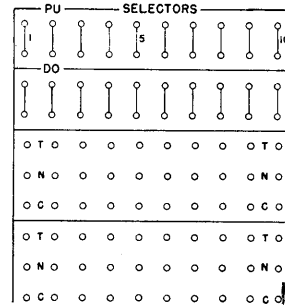

Y-AH, 21-30

Selectors. For the storage and analysis of control functions, latch-type selectors are provided. Each selector has two positions, and each position has a common, a normal, and a transferred hub. The COMMON hub is connected to the NORMAL hub until the selector is picked up by impulsing the PICKUP hub. Then the COMMON hub is connected to the TRANSFERRED hub until an impulse is sent to the DROPOUT hub.

Selectors furnish a convenient means of "remembering" specific routines that the machine has executed in the course of a program, especially when a number of alternative program sequences are possible. They may also be used to count the number of times that the machine goes through a certain routine. For example, it may be desired to substitute another item from stock if the item on an input order card is out of stock. If the item record of the ordered item contains the address of a possible substitute, the machine may look up the substitute record, and if enough stock is on hand, invoice the substitute. However, the substitute record could have as a substitute the address of the original part. If the substitute were out of stock, the machine would look up the record of the original part again, then go back to the substitute, etc. To prevent the machine from doing this, a selector may be used to allow the machine to look up one substitute, but to prevent going back to the original item record.



AA-7

Reset. Because it is frequently desirable to start a program sequence with all selectors dropped out, the selector reset hub is provided. Impulsing hub A drops out the 10 selectors.

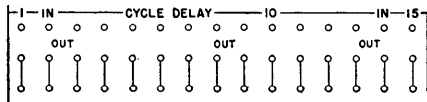

AC-AE, 6-20

Cycle Delay. These units provide a delayed impulse that may be used for control functions such as the pickup and dropout of selectors. The PROGRAM EXIT impulses are normally wired through selectors to control branching; these impulses should never be wired to the pickup or dropout of selectors they are testing, because this would cause the selector to change state while the impulse was passing through, resulting in erroneous operation. Instead, the impulse is wired into the cycle delay IN hub; it is stored and emitted from the corresponding OUT hub after the PROGRAM EXIT impulse has ended. The exit from the cycle delay is timed to allow selectors to be picked up or dropped out when there is no danger of disrupting a test impulse.

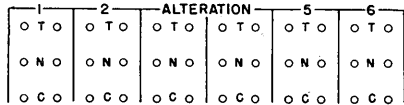

Z-AB, 9-20

Alteration Switches. A row of toggle switches on the operator's panel at the supervisory station is provided to allow various changes to be made in the program setup by changing the settings of the switches. On the control panel, these switches are wired in a manner similar to selectors. PROGRAM EXIT impulses wired into the IN hubs emerge from the N (normal) hub of the same vertical row if the corresponding toggle switch is in the normal position, and will emerge from the T (transferred) hub when the toggle switch is transferred.



AA-AB, 6

Control Impulse. Two keys are provided on the operator's panel at the console to allow a control impulse to be emitted on the control panel. This allows the operator to pick up or drop out selectors, or initiate other functions, from the console. The impulses are emitted from the correspondingly-numbered CI (control impulse) hubs on the control panel.



A, 39-40

ALC (Automatic Last Card). If the ALC switch is not plugged when the cards have run out of the card hopper, and if the last card has passed the second reading brushes, the card reader will stop. The last card information will have been transferred to the input track, and processed. The reader will then interlock on the next programmed instruction calling for a transfer of information from the input track. The operator may depress the reader

start key with the ready light out, and feed cards to the stacker. Just after the operator depresses the start key, a dummy (blank) record is transferred to the input track, and the last card selector transfers.

If the ALC switch is plugged, the card reader feeds the last card past the second reading brushes, processes this card, then feeds one additional cycle before stopping. During this additional cycle a blank record is transferred to the input track; the last card selector transfers, and any last-card routines (that have been programmed utilizing the last card selector) can be completed. The cards may then be fed into the stacker by depressing the reader start key.



B-C, 37-38

Inquire. The pair of hubs marked ON form a switch that is jackplugged if manual inquiries to the disk records are to be allowed.

The IN-OUT hubs form an interlock that is wired to allow the console to take control of the access arm at a time when it will not countermand the stored program instructions. The INQUIRE interlock is wired in the program at a point where the access arm has completed its use of the record, and is ready to move the access arm to some other record. If the arm is about to be moved by the program, no harm will be done if the operator moves the access arm to some other record to make an inquiry. When the record has been obtained for the operator, the stored program resumes control and moves the arm to the next record required.

A control impulse wired into the IN hub emerges immediately from the OUT hub if no inquiry has been set up at the console. The impulse from the OUT hub is wired to initiate the next program step.

The operator initiates an inquiry by depressing one of the three keys, Format 1, 2, or 3, on the keyboard at the console. The next time the program reaches the point where the control impulse enters the IN hub, it does not emerge from the OUT hub to continue the program, but instead lights the INQUIRE light on the console. Now the operator keys the 5-digit disk address. The access arm moves to the desired record and reads this record to the typewriter (Q) track automatically. When this has been done, the machine emits an impulse from the inquiry OUT hub to restart the stored program. The program proceeds while the requested record is typed from the Q track by the typewriter.



B-C, 39

ITI (Inquiry-Type Interlock). The typewriter may be used to make manual inquiries to the disk records as described in item 27. The typewriter may also be used as a secondary output printer by addressing the output

record to track Q and impulsing TYPE on the control panel (item 25). If *both* of these uses occur in the same program, the INQUIRY-TYPE INTERLOCK must be jackplugged to prevent either of them from writing on the Q-track while the track is being used by the other.

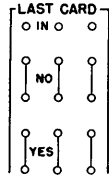

T-X, 8-10

Last Card. This selector is used to control machine operation on the run-out. Normally, a path exists between each IN hub and the NO hub beneath it. When the cards have run out of the card reader hopper and if no more cards are to be entered, the operator may depress the reader start key with the ready light out and feed the last cards to the stacker. When the last card passes the

second reading station, the last card selector transfers. The program control may be wired through this selector to control the run-out,

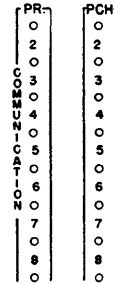

Y-AF, 3
Y-AF, 5

Communication. These hubs are connected to the correspondingly-numbered hubs of the communication section on the printer and punch control panels. They allow for signal communication between the machine units.

A SAMPLE PROGRAM

THE FOLLOWING example is presented to show the steps that are taken to plan and program an application for the machine. Although only one type of application is presented in detail, it will reveal the potential of this machine for related business applications.

Inventory Control, Billing and Accounts Receivable

A wholesale firm distributes 25,000 items to 10,000 customers. As orders arrive, they are punched and verified in the order cards, shown on the first line of the track diagram (Figure 34) and the cards are fed into the machine. For each order, the machine

1. determines availability of each item ordered,
2. prices each item,
3. adjusts stock balances,
4. invoices the customer, and
5. prepares the accounts receivable record.

The machine performs these operations in sequence for each order (Figure 33).

Some of the steps in programming the application depend on the policies and practices of the distributor. In this example, to determine availability, if there is enough stock on hand to fill the order for an item, the item is filled; but if the item cannot be filled completely, the entire quantity is back ordered. The program can be readily changed to cause the quantity on hand to be shipped, with the remainder back-ordered, or to pro-rate existing stock.

Each item in the inventory is recorded on a track in the disk memory in the arrangement shown in the track diagram. The items are coded with numbers between 00001 and 25000 to permit the part number to be used as a direct address to the corresponding part record in the disk memory.

Each customer's record is recorded on a track in the disk memory, arranged as shown in the track diagram. The customer's accounts have been assigned account numbers between 30000 and 39999 to permit direct access to these records by using customer number as address.

When an order is received, the information is punched into a card arranged as shown in the first track on the track diagram. This spread card can be punched with the item number and quantity ordered for eight items. Additional cards are used if the order is longer.

Because of the serial method used in the machine, the invoice will be set up line by line. When the cards are fed into the machine they are recorded automatically on the input track. So that no time will be lost feeding cards, the information from the input track is transferred by the program to processing track W, and another card is fed and recorded on the input track.

The customer number is used to address the memory, and when the customer record is located in the disk memory it is transferred to processing track X. Using information from the customer record and the input card, the machine assembles the invoice heading on track Y. The invoice number is supplied from an accumulator that is advanced for each invoice processed. The complete invoice heading track is transferred to the output track, from which the printer, under appropriate format control, prints the invoice heading.

As the heading is being printed, the machine reads the first item number from the order and finds the record of that item in the disk memory. This record is transferred to track Z. The quantity on hand (from the item record) is tested against the quantity ordered to determine if the order can be filled. If the quantity on hand is sufficient to fill the order, the item is invoiced; otherwise it is back-ordered.

If the item is to be shipped, the item balance is reduced by the quantity that is invoiced, and the item record is returned to the disk memory. In a similar manner, the machine processes the next item on the order, testing the availability, extending the amount, updating the item balance and printing the line on the invoice.

When the order has been completed, the total amount is printed on the invoice and added to the amount receivable on the customer's record. A test is made to determine if the customer has exceeded the credit figure established for his account; if the credit is overdrawn the order is referred to the credit manager for approval. This method relieves the credit manager of the editing of all except questionable orders.

The program planning charts and the explanations that follow show in detail how the orders are processed.

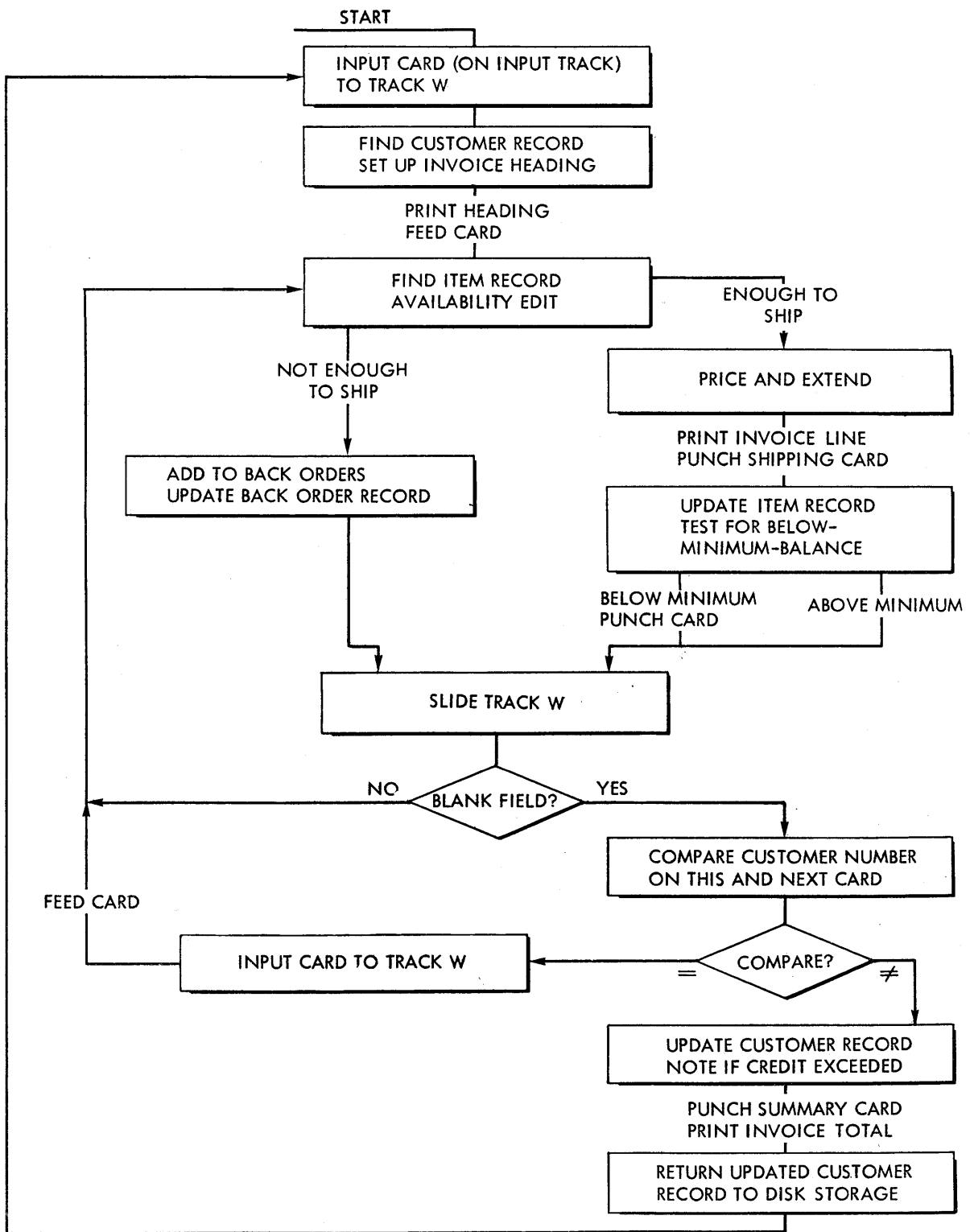

FIGURE 33. BLOCK DIAGRAM OF THE INVENTORY CONTROL AND BILLING APPLICATION

CARD, TRACK, OR RECORD		CUST. DISK ADDR.	CUST. ORDER No.	ORDER DATE M D	ITEM 1 ADDR. QTY.	ITEM 2 ADDR. QTY.	ITEM 3 ADDR. QTY.	ITEM 4 ADDR. QTY.	ITEM 5 ADDR. QTY.	ITEM 6 ADDR. QTY.	ITEM 7 ADDR. QTY.	ITEM 8 ADDR. QTY.							
INPUT CARD (CUSTOMER ORDER) TRACK W																			
CUSTOMER DISK RECORD TRACK X		CUST. DISK ADDR.	CUSTOMER NAME				STREET ADDRESS				CITY & STATE				AREA	SALES MAN	CREDIT MAX. \$	PRESENT BAL.	
CUSTOMER PRINTING RECORD INVOICE HEADING TRACK Y		CUST. DISK ADDR.	CUSTOMER NAME				STREET ADDRESS				CITY & STATE				CUST. ORDER No.	ORD. DATE M D	INVOICE NUMBER		
ITEM OUTPUT RECORD TRACK Y		ITEM DISK ADDR.	ITEM DESCRIPTION				UNIT	UNIT PRICE	ON HAND	ON ORD.	BACK ORD.	MIN. BAL.	ITEM CL.	ITEM CODE	QTY. SHIP	EXTENSION AMOUNT	CUST. ORD. No.	ORD. DATE M D	INVOICE NUMBER
BACK-ORDERED ITEM RECORD TRACK Y		ITEM DISK ADDR.	ITEM DESCRIPTION				UNIT	UNIT PRICE	ON HAND	ON ORD.	BACK ORD.	MIN. BAL.	ITEM CL.	ITEM CODE	QTY. BACK ORD.		CUST. ORD. No.	ORD. DATE M D	INVOICE NUMBER
ITEM DISK RECORD TRACK Z		ITEM DISK ADDR.	ITEM DESCRIPTION				UNIT	UNIT PRICE	ON HAND	ON ORD.	BACK ORD.	MIN. BAL.	ITEM CL.	ITEM CODE					
ACCOUNTS RECEIVABLE INVOICE SUMMARY RECORD INVOICE TOTAL FOR PRINTING TRACK Y		CUST. DISK ADDR.	CUSTOMER NAME				AREA	INDUSTRY	SALES MAN	CREDIT MAX. \$	PREVIOUS BAL.	AMOUNT OF THIS INVOICE	NEW BAL.	EXCEEDS CREDIT BY			CUST. ORDER No.	ORDER DATE M D	INVOICE NUMBER
DIGIT EMITTER TRACK I		0 1 2 3 4 5 6 7 8 9																	
ACCUMULATORS		PRODUCTS				NEW ITEM BALANCE		INVOICE TOTAL NEW CUST. BAL.		TOTAL BACK ORDERS				INVOICE NUMBER					
						ON HAND		EXCESS CR.						M D SERIAL					
		0 5 10 15 20 25 30 35 40 45 50 55 60 65 70 75 80 85 90 95																	

FIGURE 34. TRACK LAYOUT DIAGRAM

Prog. Step	FROM		TO		No. Characters	Control
	Track	Position	Track	Position		
00	K	9 9	W	9 9	0 0	
01	W	0 4	J	9 9	0 5	
02	I	0 1	L	8 9	0 1	
03	L	8 9	Y	9 9	0 8	
04	W	1 5	Y	9 1	0 9	
05	R	9 9	X	9 9	0 0	
06	W	0 4	X	0 4	0 5	A 1
07	X	7 9	Y	7 9	8 0	
08	Y	9 9	S	9 9	0 0	B
09	W	2 0	J	9 9	0 5	
10	W	2 3	Y	6 1	0 3	

When the START hub emits, the stored program is started at step 00.

This program step moves the input card from the input track to track W in the processing unit. Because the card on the input track contains only 80 columns, the last 20 positions of the input track will always be blank. The input card contains a spread order of up to eight items. If the card is filled, the machine will recognize that it has completed the card when it reaches the blank columns. If the card is not filled, the machine will recognize that it has completed the card when it reaches a blank field.

The first five digits of track W contain the customer number. This is sent to the address register to cause the access arm to move to the location where the customer record is stored in the disk memory.

While the access arm is moving to the location of the customer record in the disk memory, other operations may be performed. This instruction causes a 1 from emitter track I to be added into accumulator 8 to increase the invoice number.

The new invoice number is transferred from the accumulator to processing track Y:

The customer order number and order date are assembled on track Y, which also contains the invoice number. Steps 02, 03 and 04 take place while the access arm is moving to the location of the customer record.

When the access arm has reached the record, the customer record is transferred from the disk to processing track X.

The customer disk address from the input card and the disk address on the disk record are compared to prove that the machine obtained the proper record.

To complete the assembly of the invoice heading, the customer name and address are transferred from track X to track Y and combined with the invoice number, customer order number and order date that have already been recorded on the track. The invoice heading information is now completely assembled on track Y.

The assembled heading is transferred to the output track, and the control code B brings the control to the control panel, where the control impulse is wired to cause the printer to print the invoice heading. Format control on the printer allows the information to be rearranged as desired.

While the printer is printing the invoice heading, the following program instructions determine the availability of the first item on the order. First, it is necessary to locate the item record in the disk memory and bring it to the processing unit. The item number is the address of the item record.

This instruction places the item number in the address register to cause the access arm to move to the location where the item record is stored in the disk memory.

While the access arm is moving to the location of the item record, the invoice line is assembled on track Y. This step moves the quantity ordered to track Y.

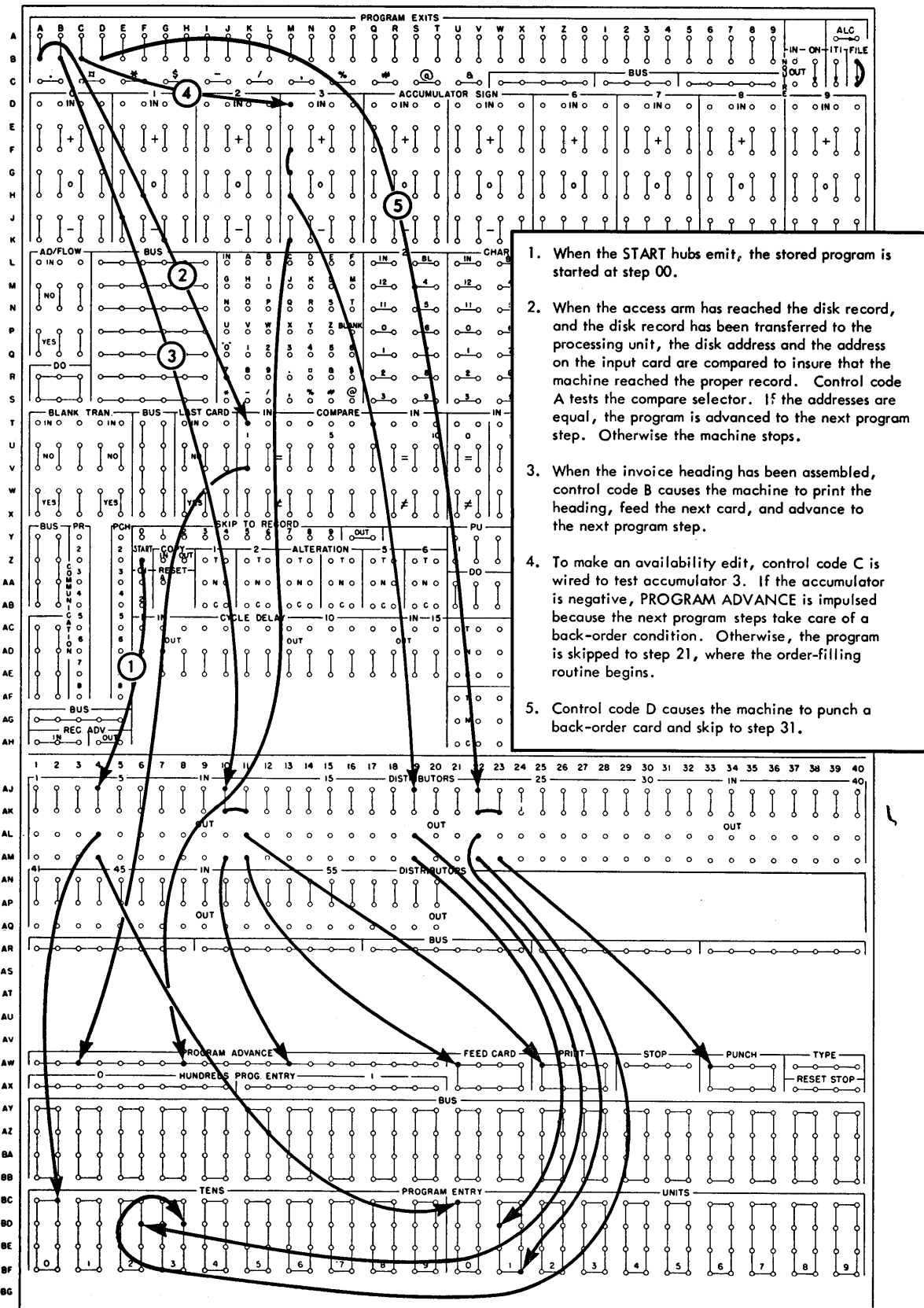

1. When the START hubs emit, the stored program is started at step 00.
2. When the access arm has reached the disk record, and the disk record has been transferred to the processing unit, the disk address and the address on the input card are compared to insure that the machine reached the proper record. Control code A tests the compare selector. If the addresses are equal, the program is advanced to the next program step. Otherwise the machine stops.
3. When the invoice heading has been assembled, control code B causes the machine to print the heading, feed the next card, and advance to the next program step.
4. To make an availability edit, control code C is wired to test accumulator 3. If the accumulator is negative, PROGRAM ADVANCE is impulsed because the next program steps take care of a back-order condition. Otherwise, the program is skipped to step 21, where the order-filling routine begins.
5. Control code D causes the machine to punch a back-order card and skip to step 31.

FIGURE 35. SAMPLE PROGRAM — CONTROL PANEL WIRING — PART 1

Prog. Step	FROM		TO		No. Characters	Control	
	Track	Position	Track	Position			
11	W	2 3	M	3 9	0 3		5
12	R	9 9	Z	9 9	0 0		
13	W	2 0	Z	0 4	0 5	A	1
14	Z	5 8	Y	5 8	5 9		
15	Z	3 9	L	3 9	0 4	C	
16	I	0 5	Y	0 6	0 1		
17	Y	6 1	L	7 9	0 3		
18	Z	4 7	L	7 9	0 4		
19	M	7 9	Z	4 7	0 4		
20	Y	9 9	S	9 9	0 0	D	
21	I	0 3	Y	0 6	0 1		
22	Z	3 5	V	9 9	0 5		
23	W	2 3	N	9 9	0 3		
24	L	1 1	Y	6 9	0 8		
25	M	1 1	L	4 9	0 8		

For an availability edit, the quantity ordered is subtracted into accumulator 3. Note the use of the reset-subtract instruction.

The item record is brought from the disk memory to track Z.

The item disk address from the input card and the disk address on the item record are compared to prove that the machine obtained the proper record.

The item record is inserted on track Y to assemble the item printing line.

The on-hand quantity in the item record is added into accumulator 3. Now, if the accumulator is zero or positive, there is a sufficient quantity of the item on hand to make shipment. If the accumulator is negative, the item must be back-ordered. Program exit C emits an impulse that is used to test the condition of the accumulator. If accumulator 3 has a positive or zero balance, it indicates that sufficient stock is available for the order to be filled, and the program is transferred to step 21. If the accumulator is negative, the control panel wiring transfers the control to step 16.

The following instructions handle the back-order condition.

This instruction places a 5 in the application code column to indicate to the output units that the record is a back-order.

The quantity back-ordered is added into accumulator 7.

Any previous quantity back-ordered is added into accumulator 7 to obtain a new total of back orders for the item.

The back-order total is inserted in the item record.

The assembled back-order record is moved to the output track, and the machine is controlled to punch the back-order card and skip to program step 31. Step 31 will return the updated item record to the disk memory.

If there is sufficient stock on hand to make shipment, the program will have been skipped from step 15 to step 21. The following program steps prepare a detail line on the invoice.

Code 3 is inserted into the application code column to identify the output record as a shipment.

The unit price is loaded on the multiplicand track as the machine prepares to obtain the item extension.

The quantity is used for the multiplier to obtain the extension. When the machine reaches this instruction, multiplication will take place.

The product is developed in accumulators 0 and 1. From the accumulator, the product is transferred to track Y.

The extension is added into accumulator 4 to obtain a total of all the items on the invoice. This instruction also resets accumulators 0 and 1.

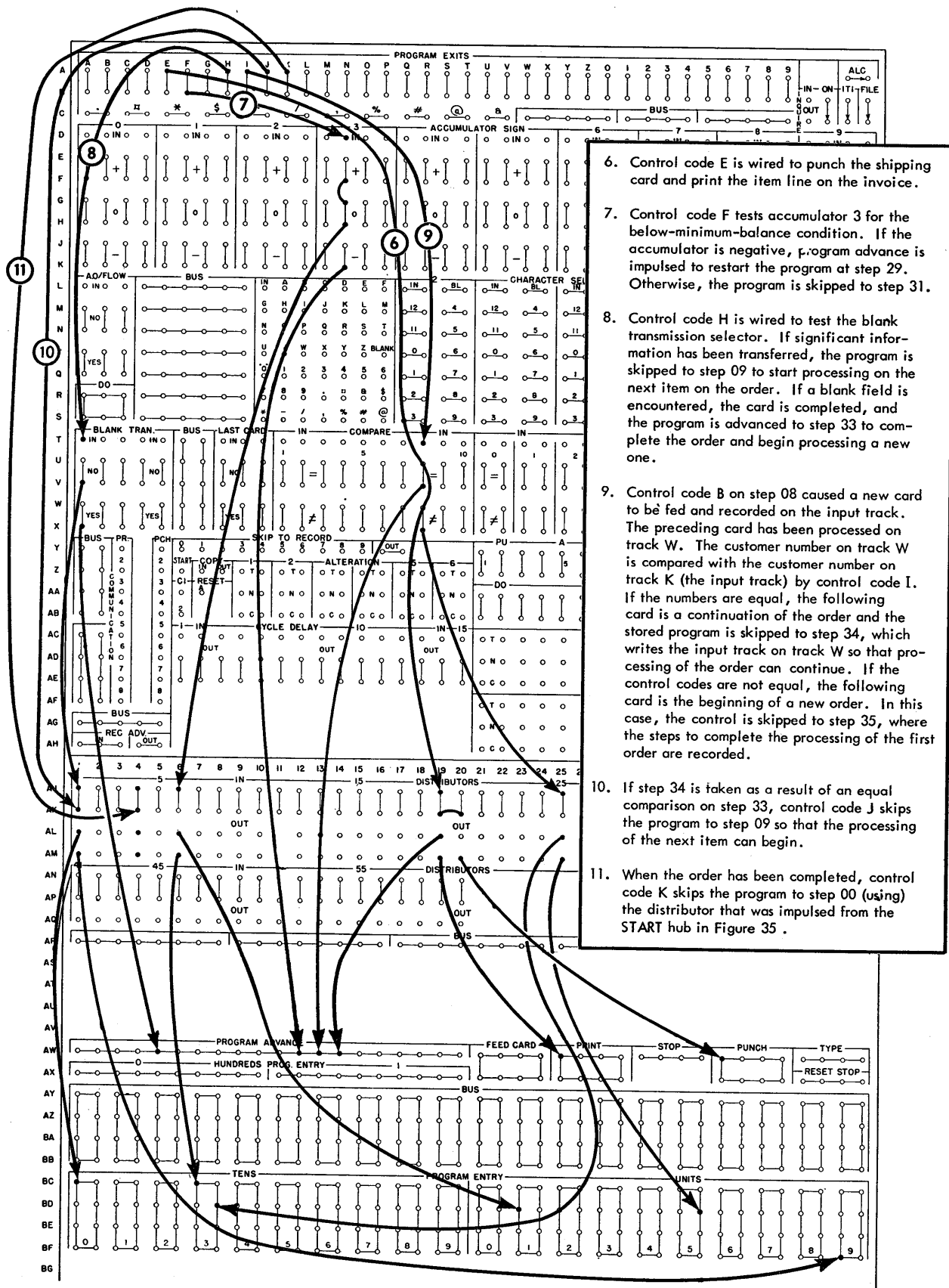

6. Control code E is wired to punch the shipping card and print the item line on the invoice.
7. Control code F tests accumulator 3 for the below-minimum-balance condition. If the accumulator is negative, program advance is impuled to restart the program at step 29. Otherwise, the program is skipped to step 31.
8. Control code H is wired to test the blank transmission selector. If significant information has been transferred, the program is skipped to step 09 to start processing on the next item on the order. If a blank field is encountered, the card is completed, and the program is advanced to step 33 to complete the order and begin processing a new one.
9. Control code B on step 08 caused a new card to be fed and recorded on the input track. The preceding card has been processed on track W. The customer number on track W is compared with the customer number on track K (the input track) by control code I. If the numbers are equal, the following card is a continuation of the order and the stored program is skipped to step 34, which writes the input track on track W so that processing of the order can continue. If the control codes are not equal, the following card is the beginning of a new order. In this case, the control is skipped to step 35, where the steps to complete the processing of the first order are recorded.
10. If step 34 is taken as a result of an equal comparison on step 33, control code J skips the program to step 09 so that the processing of the next item can begin.
11. When the order has been completed, control code K skips the program to step 00 (using) the distributor that was impuled from the START hub in Figure 35.

FIGURE 36. SAMPLE PROGRAM — CONTROL PANEL WIRING — PART 2

Prog. Step	FROM		TO		No. Characters	Control	
	Track	Position	Track	Position			
33	K	04	W	04	05	I	1
34	K	99	W	99	00	J	
35	X	04	J	99	05		
36	X	31	Y	31	32		
37	X	99	Y	51	20		
38	L	49	Y	58	07		
39	X	99	L	49	07		
40	L	49	X	99	07		
41	L	49	Y	65	07		
42	X	92	M	47	05		
43	M	49	Y	72	07		
44	I	07	Y	06	01		
45	Y	99	S	99	00	E	
46	R	99	Z	99	00		
47	Z	04	X	04	05	A	1
48	X	99	R	99	00	K	

If the test on step 32 indicates that the card has been completed, it will be necessary to transfer the next card to the processing unit to continue operation. The following card may be a continuation of the order that is being processed, or it may contain a different order, in which case the current order must be completed before processing can begin on the new order. This instruction compares the customer number of the order being processed with the customer number on the following card, which has been recorded on the input track. If the codes are equal, the next card is a continuation of the order, and the program advances to step 34. Otherwise, the present order must be completed and the following order started from the beginning. In this case, the control is skipped to step 35.

If the following card is a continuation of the order, this instruction transfers the card to processing track W, and the control code J then skips the program to step 09 so that the next item can be processed.

If the following card is not a continuation of the order, this instruction begins the sequence of steps that result in completing the invoice and updating the customer record. This instruction directs the access arm to return to the customer record in the disk memory. It is placed here so that the access time may be used to perform the operations of program steps 36-45, thus reducing the effective access time.

Customer information is transferred from track X to track Y to assemble the summary card.

The invoice total is transferred from accumulator 4 to track Y.

The customer's previous balance is added to the invoice total in accumulator 4.

The new customer balance is transferred to track X to update the customer record.

The new customer balance is transferred to track Y to appear in the summary card.

The customer's allowed credit maximum is subtracted from accumulator 4 to determine if the customer has exceeded his credit.

The result from accumulator 4 is transferred to track Y to appear on the summary card. The maximum credit information will be printed with the total amount of the invoice, but it will be printed on the margin and torn off before the invoice is sent out. This serves as a signal to the credit manager that a customer's credit has been exceeded.

A 7 is emitted to identify the accounts receivable summary card.

Track Y is transferred to the output track. From the output track, the total amount of the invoice and the credit information will be printed. The remaining information assembled above will be used to punch a summary card.

When the access arm has reached the customer's record, the record is transferred to track Z, so that its location may be checked.

The address on the record on track Z is compared with the address on track X. If the addresses are the same, the head is located on the right track. Otherwise the machine will stop.

The updated customer record is returned to the disk memory. The K program code returns the program to step 00.

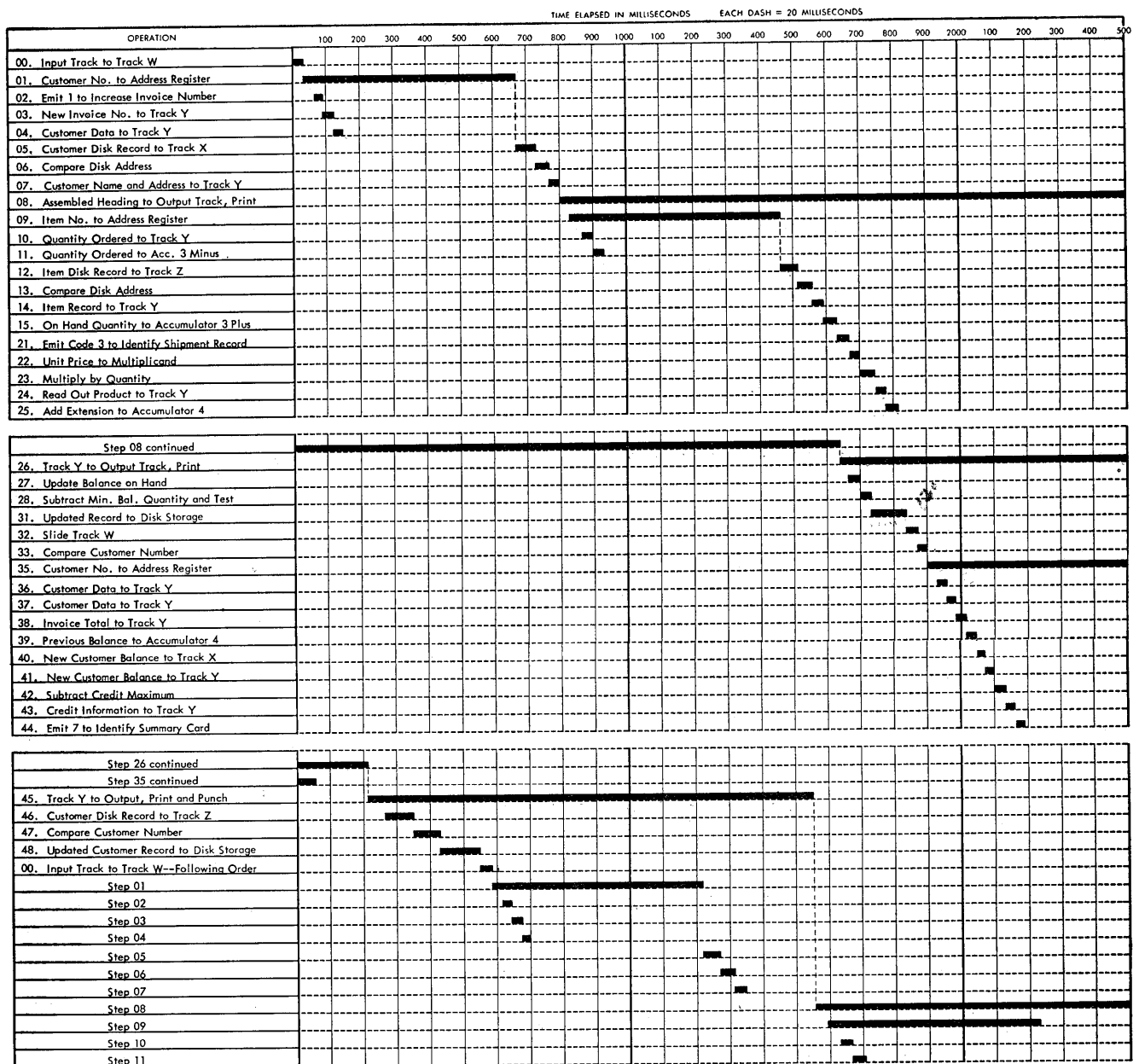

FIGURE 37. SAMPLE PROGRAM — OPERATION SCHEDULE CHART

Time Required

The operation schedule chart (Figure 37) shows the time consumed by each program step. The chart is drawn on the assumption that the invoice heading will have three lines of 40 characters each and that each body line will contain about 40 characters, including spaces. An approximate access time of 600 milliseconds is used for the disk storage; actual time should be better than this if the item records are grouped.

The chart shows that virtually all of the processing time can be overlapped with the printing. The time for each invoice may be determined as approximately 4500 milliseconds for the invoice heading and total line, plus 1160 milliseconds for each item line. Each back-ordered item will add about 600 milliseconds to the time required for the invoice. Assuming an average of three items per invoice and neglecting back orders, the machine will process about 450 invoices per hour, maintaining all pertinent records.

A sample invoice is shown in Figure 38.

CABLE ADDRESS: HENFA		MEMORIAL 7-8881			
HENRY JOHN & CO.					
MEMORIAL SQUARE PATERSON, NEW JERSEY					
SHIP TO: HENRY SMITH AND CO		3792 LINDANE DRIVE		JUNCTION, N. Y.	
				INV. NO. 81630	
				ORDER NO. 1592A	DATE 7 15
QUAN.	UNIT	PART NUMBER	DESCRIPTION	UNIT PRICE	AMOUNT
15	EA	20019	MONKEY WRENCH	2.49	37.35
2	EA	30103	TWIST DRILL	.53	1.06
100	LB	90012	PLASTER PARIS	.05	5.00
					43.41

FIGURE 38. SAMPLE INVOICE

DISK STORAGE ORGANIZATION

THE disk storage unit is divided logically into 50,000 100-character sectors. The master accounting records must be fitted into these 50,000 sectors. The best arrangement of the accounting records on the disks will be determined by:

1. The number of different types of records that must be stored.
2. The number of records of each type.
3. The number of characters in the records of each type.
4. The method of addressing the records.

Ideally, the accounting records to be stored in the memory are given the account number of their disk address. For example, part number 12345 has its record stored at disk location 12345. This arrangement is called *direct addressing* and it has the obvious advantage that the account number can be used directly to address the disk storage.

When only one type of record is stored in the disk storage, if the account numbers are assigned between 00000 and 49999 they can readily be used for direct addressing. If more than one type of record is stored, it is desirable to group the records in the memory.

EXAMPLE: It is desired to provide disk storage for:

- 15,000 inventory item records
- 8,000 accounts receivable records
- 4,000 accounts payable records
- 4,000 employee records
- 3,000 miscellaneous records

To allow room for future expansion, these records could be arranged as follows:

	<u>ADDRESSES</u>
Miscellaneous records	00000-04999 (5 disks)
Accounts payable records	05000-09999 (5 disks)
Accounts receivable records	10000-19999 (10 disks)
Inventory item records	20000-39999 (20 disks)
Employee records	40000-49999 (10 disks)

With the records organized in this way, programming may be simplified because the machine can immediately determine that 12345 is the address of an accounts receivable record.

Because employee records will most probably require more than 100 characters, two sectors have been allowed for each employee record. With this arrangement, the employee record would always start on an even address and end on the following odd address. For direct addressing, employees would be assigned even employee numbers only.

A modification of this system would be to assign employee numbers between 20000 and 24999, assigning both odd and even numbers. An auxiliary code punched in the input card would allow the machine to recognize an employee card. By doubling the employee number, an *even* address between 40000 and 49998 would be obtained. As an example, employee number 23433 would be doubled to 46866, an even address that contains the first 100 characters of the employee record. After sector 46866 is obtained, record advance is impulsed and the machine obtains sector 46867, which contains the last 100 characters in the employee record.

Ease of unloading is another advantage that is obtained by grouping records in a manner similar to the example just shown. Periodically, it will be desirable to punch or print out certain records to obtain a permanent record of the status of the disk storage for auditing purposes. The machine may be easily caused to punch or print out only the accounts receivable records by a program that causes the access arm to obtain record 10000 and then advance to 10001, etc., until 19999 has been processed. If the records are not grouped, but are scattered through the memory, it will be necessary to run a deck of cards through the reader to specify which of the scattered records are desired.

Where it is not possible to assign a direct disk address it is sometimes possible to punch the disk address in the input cards. Sometimes the disk address can be prepunched in the card; this is the case when IBM time cards are used for input when calculating payroll. It may be possible to append the disk address to the account number. For example, part number 4709GXP could become 4709GXP-23456, where 23456 is the disk address of the part record.

Programmed Addressing

Where none of these methods is possible it will be necessary for the machine to perform arithmetic operations on the existing part or reference numbers to arrive at disk addresses between 00000 and 49999. It is not possible to specify any one method of making this translation; each situation must be studied individually to determine the best method of changing an external address, such as a part or employee number, into a disk address between 00000 and 49999. Some of the methods that have been investigated and found practical are:

1. Using a fixed portion of the external address.

Shown below are a random sampling of part numbers from a catalog of a prominent mail-order firm:

24W356
53TP4152
53T4149
30T1441
MW5092
48T773
78T3560
45TP4959
67TN12

Of course, this analysis would normally be made on an entire catalog. When this part number arrangement is analyzed, it is found to have a two-digit prefix, a one or two-digit letter code and a four digit item code. The following codes are obtained by listing the preceding codes in columnar form and inserting zeros where there are no characters in the code:

24	W0	3560
53	TP	4152
53	T0	4149
30	T0	1441
00	MW	5092
48	T0	7730
78	T0	3560
45	TP	4959
67	TN	1200

The first method that suggests itself is to use the four-digit numerical code with one other digit to generate a unique five-digit address. If the first digit of the prefix code is combined with the four-digit code, some addresses would result that are greater than 49999. To insure that all addresses are acceptable

the machine could be programmed to subtract 5 from any prefix digit greater than 4. The following addresses would then be obtained:

23560
04152
04149
31441
05092
47730
23560
44959
11200

These are all acceptable disk addresses. Unfortunately, address 23560 has been duplicated. If it is not possible to change the part number of one of these items, another method must be used. However, before this method is abandoned, other combinations of digits should be tried. Note that the numerical portions of the alphabetic characters can be used as another digit, and the zone portions can be translated to digits through programming. Conventional punched-card equipment can be used to facilitate these analyses.

If a workable address system is obtained by this method, after the disk storage is loaded it will be possible to punch or print out the unused disk addresses to supply a list for future part number assignments.

This method has the advantage that comparatively little arithmetic must be performed on the part numbers to obtain disk addresses, and no disk storage is required for indexing the records.

2. *Derivation of a Disk Address from Sums.* Another method involves smoothing of the original distribution by converting the existing set of external addresses to another set, and in the process removing practically all of the effects of the original number assignment policy. Mathematicians call this process "randomizing" and have developed several methods for performing the conversion. One method of randomizing is to develop new disk addresses from the sums of certain columns in the existing address.

Because the accumulators accept only the numeric

portion of the alphabetic characters, the later can be treated as numbers. The sample part numbers used earlier now become:

24603560
53374152
53304149
30301441
00465092
48307730
78303560
45374959
67351200

Now if the low-order four digits are added to the high-order four digits, but shifted one position to the left, the following addresses are obtained after 5 is subtracted from any high-order position greater than 4:

38060
46857
46820
17440
00966
32130
43430
04127
18735

If there are no duplications of addresses when the entire set of external addresses is processed, this method would be practical. Note that the disk addresses bear no resemblance to the catalog numbers from which they are generated. The effect of this operation is to distribute the records evenly into the 50,000 sectors in the memory. The arithmetic is performed on the external addresses when the record is first entered into the memory, and whenever the record is to be brought from the memory.

Another method of randomizing is by squaring a portion of the external address and extracting an internal address from the result. This method will be treated in detail later.

It is not very probable that the procedures outlined above will yield unique internal addresses for all external addresses. As the number of items increases, the probability that an address will be duplicated increases at a rapid rate. To illustrate, suppose ten buckets are placed in a cluster and a blindfolded person tosses ten balls, one at a time, into the cluster. The cluster is arranged so that each ball must fall into one of the buckets, and there is an equal

chance that it will fall into any bucket. When the first ball is tossed, there is no possibility that it will fall into a bucket that already contains a ball; but when the second ball is tossed, there is one chance in ten that it will fall in the bucket that already contains the first ball. When the third ball is tossed, there are two chances in ten that it will fall into a bucket that already contains a ball, provided the second ball did not fall into the bucket containing the first ball. If it did, there is now one chance in ten that the third ball will fall into the bucket containing the other two. From this it can be seen that the chance of the tenth ball falling into an empty bucket is very slight.

Now suppose that 1000 balls are tossed into the ten buckets. There is an excellent chance that about 100 balls will fall into each bucket. As the number of balls is further increased, the probability of an even distribution is increased. Therefore, although it is not very probable that the address modification processes described earlier will yield *unique* disk addresses, there is an excellent probability that, as the number of records that can be assigned to an address increases, the probability of an approximately even distribution of the records into the storage increases.

The organization of the random-access memory suggests a method of applying this principle for programmed addressing. Each disk track contains ten sectors. In effect, a disk track is a "bucket" in which ten records can be stored *at the same address*. Instead of the 50,000 sectors that store 100 characters each, the memory will be considered to have 5000 tracks, each of which can store up to 10 records of 100 characters each. The techniques shown earlier can be used to generate a 4-digit address between 0000 and 4999. This address is then used to reach the first sector on a track. For example, if the address arithmetic yields 1234 as an address, the arm would be sent to disk number 12, track number 34. If the memory is being loaded, the machine would be programmed to record in the first empty sector on this track.

This technique will result in the majority of records being located at the track address generated by the address arithmetic. Occasionally, more than 10 records would have the same address. When this occurs, the excess records may be stored on *overflow* tracks. To move the access arm to an overflow track requires

another seek operation, with an inherent loss of time; therefore it is desirable to use the overflow tracks for the least-often-used records. This can be done by loading the most-often-used records first; these records will be recorded in preferred locations. Less-used records are then loaded in less preferable positions. When the least used records are loaded, they are recorded on any sectors that are left in the main storage area, and then any overflow is recorded in the overflow area.

Although it is possible to record ten records on each track, better access will be achieved by reserving one sector on each track as an index to the other nine sectors. A method of programmed addressing that uses this technique will now be shown. This method has the following advantages:

All but a small percentage of the records are reached with a single movement of the access arm.

Additional access motions are limited to items of low activity.

The index to the records is automatically constructed and maintained as each item is added to or deleted from the disk storage.

Any portion of the memory can be assigned for a group of records. Thus, several different groups of records can be stored in the same disk storage unit.

The method can be applied to practically any external addressing system.

The method of loading a record into the disk storage will now be traced, first in an example and then with the presentation of the actual blocked program routine. To show the flexibility of the method, the example will be concerned with loading the inventory item records in the example discussed earlier, in which 15,000 inventory item records were to be loaded into addresses 20000-39999. Consider the inventory item 53TP4197 which, to the arithmetic sections of the machine appears as 53374197.

It is possible that the numerical portion, 4197, is a part of a randomly-assigned sequence of numbers having nearly equal distribution over the range from 0000 to 9999. If the distribution is approximately even, there would be no need to perform a randomizing arithmetic operation on the number. Merely subtract 5 from the high-order position of any number above 4999.

If it is assumed that the distribution is uneven, the entire external address should be used to develop a 4-digit random address. From the arithmetic standpoint, this is most easily done by squaring the address. For the item address 53TP4197,

$$\begin{array}{r}
 53TP4197^2 = \quad 53374197 \\
 \quad \quad \quad \quad 53374197 \\
 \hline
 \quad \quad \quad \quad 373619379 \\
 \quad \quad \quad 480367773 \\
 \quad \quad 53374197 \\
 \quad 213496788 \\
 \quad 373619379 \\
 \quad 160122591 \\
 \quad 160122591 \\
 266870985 \\
 \hline
 2848804905394809
 \end{array}$$

The center four digits, 4905, are each obtained by adding seven or eight other digits. These four digits can be expected to be the most random in the product, and when additional item addresses are treated in this manner these digits will tend to have an even distribution over the numbers between 0000 and 9999. In other words, squaring a number and extracting an address from the center of the square tends to assign addresses in a random manner.

In the event that the external address is too large to be handled in this way, the address could be overlapped and added, as described earlier, and the reduced address could then be squared.

The random numbers obtained from the center of the squared external address range between 0000 and 9999. The available addresses in the machine are between 0000 and 4999. It is therefore necessary to "compress" the random numbers to fit the disk storage. Multiplying by a factor of .5 will reduce the random address to a disk address between 0000 and 4999, as shown in the following examples:

Random Address	0000	5555	9999
	× .5	× .5	× .5
Disk Address	0000.0	2777.5	4999.5

However, in this example, it is desired to store the item records on the 20 disks having the addresses 20000-39999. This could be done by multiplying by a compression factor of .2, but because of the overflow possibility it is desirable to have an overflow

area at the end of the assigned addresses. The application of a compression factor of .19 will assign the item records to the first 19 disks, reserving the 20th disk for overflow. Part number 53TP4197, randomized to 4905, now becomes

$$\begin{array}{r}
 4905 \\
 \times .19 \\
 \hline
 44145 \\
 4905 \\
 \hline
 0931.95
 \end{array}$$

Address 0931 would locate the record on track number 31 of disk number 09. To cause the address to fall into the range between 20000 and 39999, a shifting factor of 20000 is added to all addresses. The address now becomes

$$\begin{array}{r}
 20000 \\
 0931 \\
 \hline
 29310
 \end{array}$$

In the process of adding the shifting factor, the low-order zero may be added to the address. This address is now sent to the address register, and when the access

arm has moved to the disk track the zero record is brought to a track in the processing unit (Figure 40).

Sector 29310 contains an index to the nine records stored at addresses 29311-29319, as shown in Figure 39. The 100 characters on this track are organized into ten fields of ten characters each, corresponding to the accumulators. When a record is entered into the memory, its external address is entered in the corresponding ten-digit field. If no entry has been made, the field will be blank.

The index record is read from the disk to track X of the processing unit (Figure 41). From track X, it is added into the accumulators. Each accumulator is scanned for blanks. If an entry is present, the accumulator will be positive, but if the field is blank a zero reading will be obtained.

To enter record 53TP4197 in the memory, the machine is programmed to find the first open sector in the series 29311-29319. The external address is entered in the corresponding field of the index record. The index record is returned to the disk storage and the address of the open sector is obtained by use of

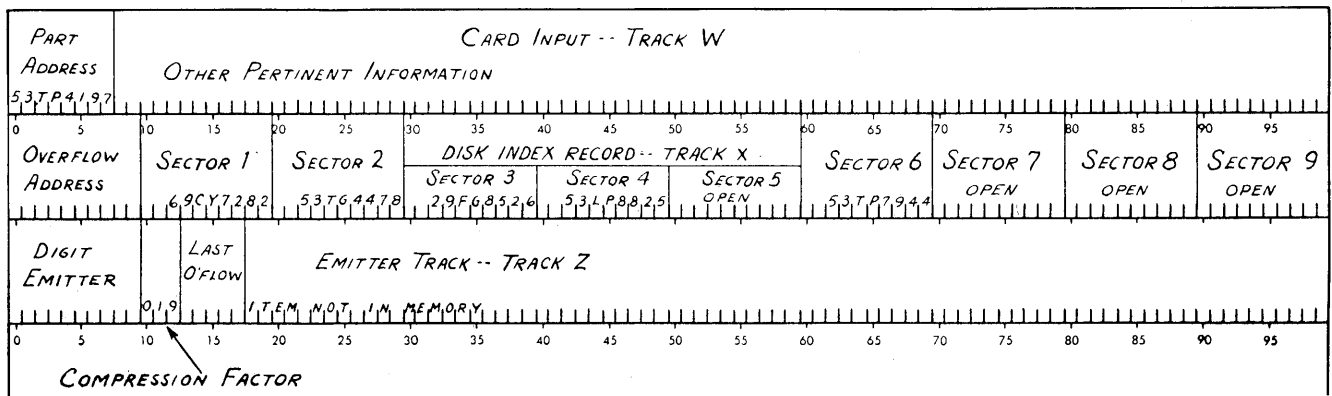

FIGURE 39. TRACK DIAGRAM

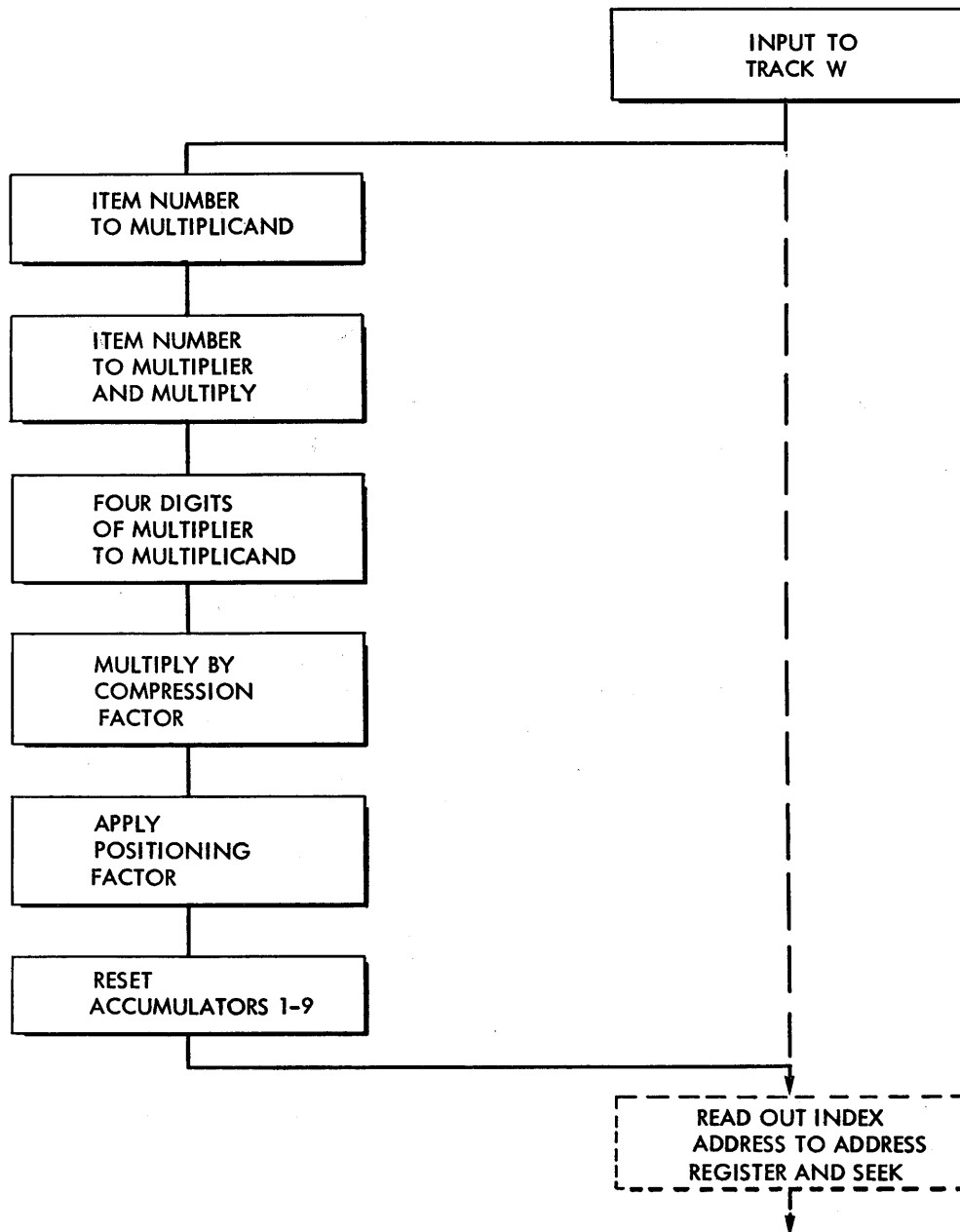

FIGURE 40. BLOCK DIAGRAM — GENERATING THE INDEX ADDRESS

the record advance feature on the control panel. Because the access arm is already positioned on the track, no movement of the arm is required. The record of part 53TP4197 is now recorded in the open sector,

When, on testing the accumulators, all sectors are found to be filled, an overflow condition exists and the record must be stored on another track. The

randomized address may be increased by 10, and an attempt made to store the record on the next track. Alternatively, the address of an overflow track may be recorded in the zero index record. Although this method requires longer access time for overflow items, it results in easier file maintenance and will be carried through in the program that follows. This program is blocked out in Figure 41.

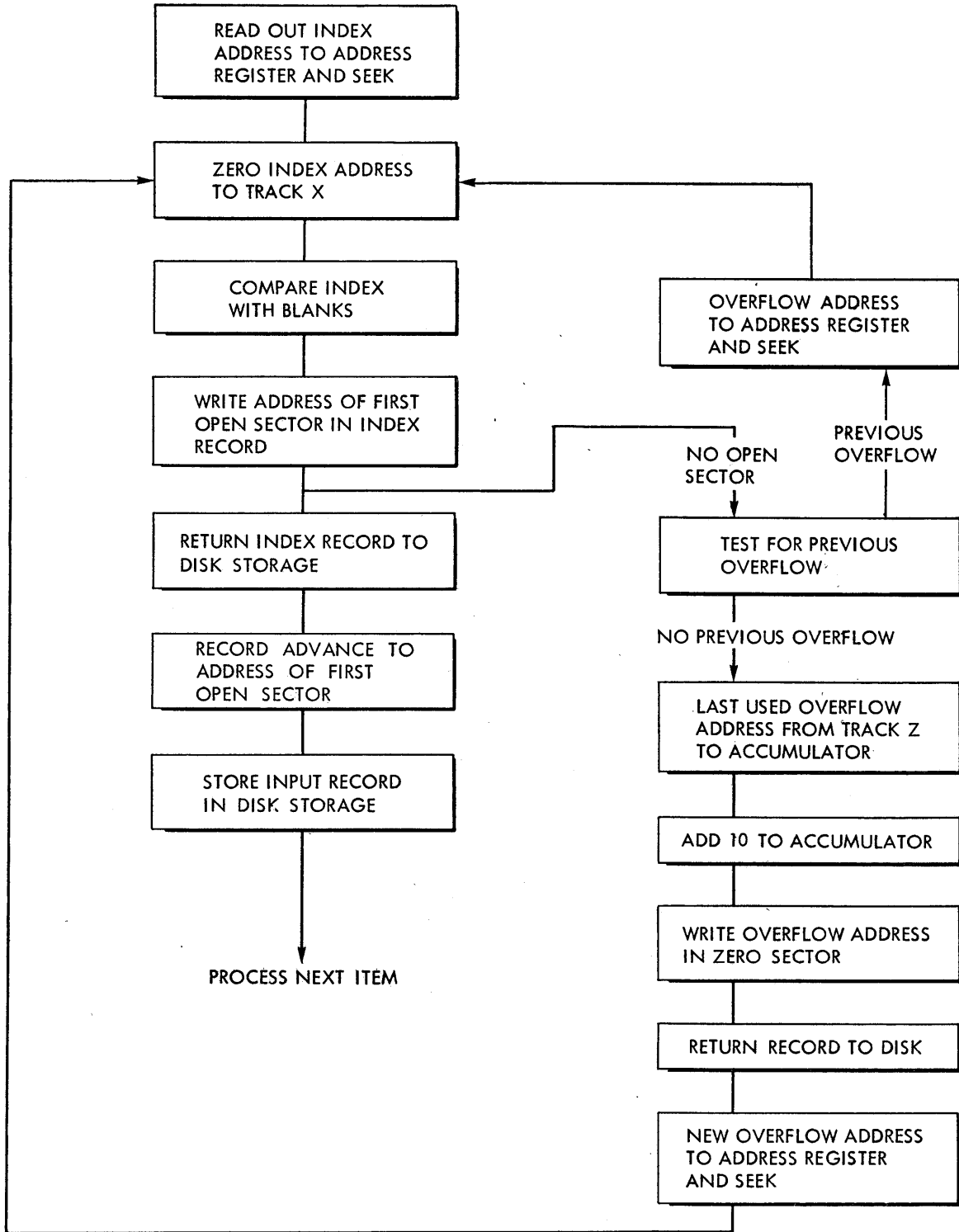

FIGURE 41. BLOCK DIAGRAM — CONSTRUCTING THE SECTOR INDEX AND STORING THE RECORD

Locating the Record During Processing (Figure 42)

When the records are required for processing, a similar operation is performed. The external address is transformed to the random address and the index record is obtained from the disks. While the arm is moving to the location of the index record, the input address is sent to the multiplicand track, where it is written ten times in positions corresponding to the fields of the field-compare unit. When the index record is obtained, it is compared with the external address from the multiplicand track. If any field compares equal, the corresponding sector contains the de-

sired record. The SKIP-TO RECORD hub for that sector is impulsed, and the record is brought to the processing unit.

If none of the fields compare equal, the zero field is tested to determine if an overflow has been recorded. If an overflow address is present, it is sent to the address register, the zero index record is brought to the processing unit, scanned, and if an equal is found, the corresponding sector contains the desired record. If no equal is found, and there is no overflow address, the item is not recorded in storage, and the machine may be programmed to indicate this condition on the typewriter.

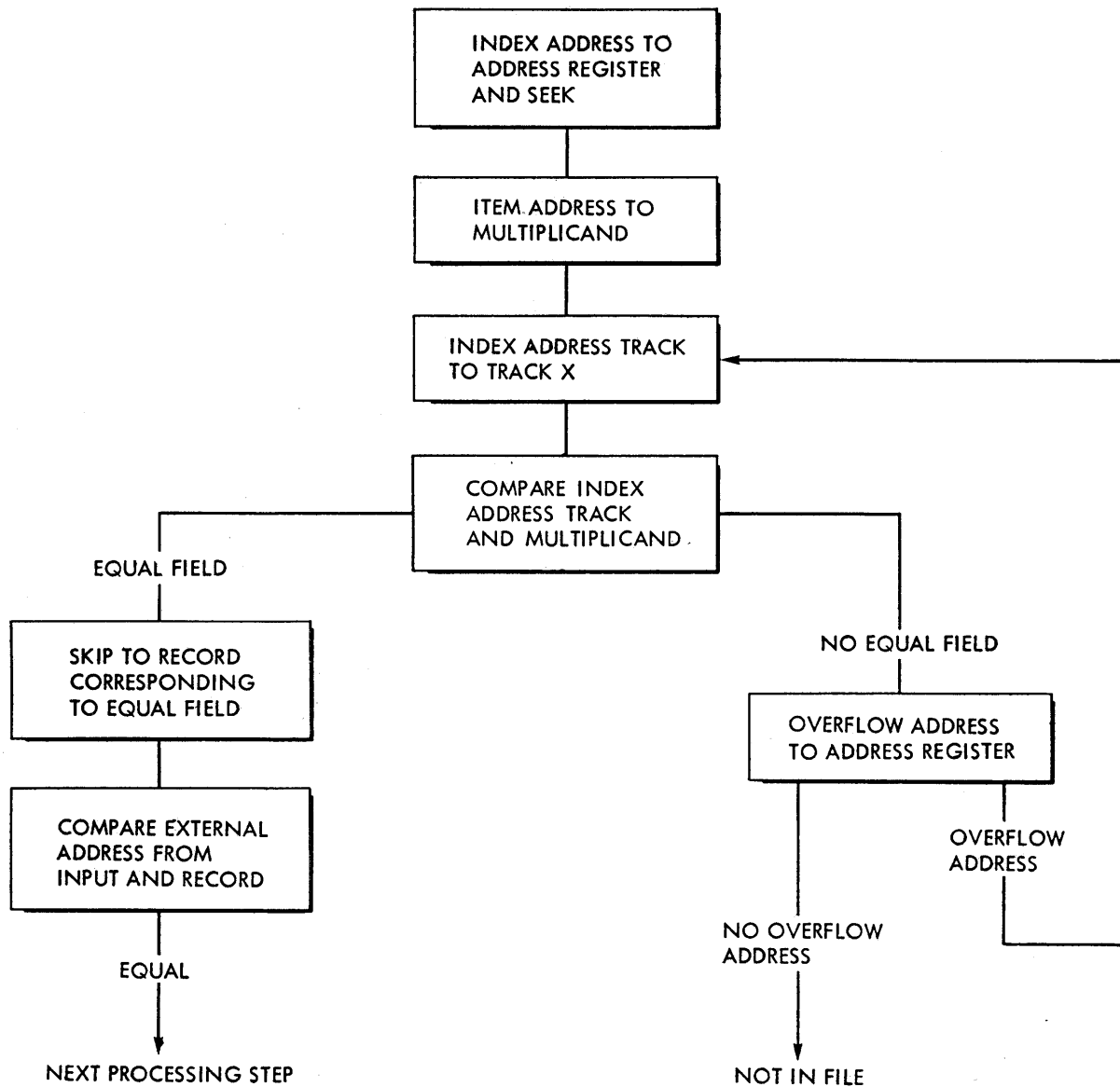

FIGURE 42. BLOCK DIAGRAM — LOCATING THE RECORD DURING PROCESSING

INTERNAL CHECKING

INTERNAL checking devices are built into the machine to monitor the transfers of information and assure that characters transferred are permissible codes.

Character Coding System

Figure 43 shows the coding system used for recording information in IBM punched cards. Punching is done in two main areas in the card. The lower (numerical) section records the digits 0-9 and the upper section, used in combination with the numerical section, records alphabetic and special characters.

The numerical section is divided into ten horizontal rows, one row for each digit 0-9. The zone section is divided into three horizontal rows, 0, 11 and 12. The zero row is common to both zone and numerical sections. The digits are identified by single punches; the letters and special characters by combination of zone punching with digits.

The 12-zone in combination with the digits 1-9 forms the letters A-I, the 11-zone with the digits 1-9 forms the letters J-R and the 0-zone with the digits 2-9 forms the letters S-Z.

The method of coding these characters on the disk

and drum tracks is shown in Figure 44. Information is recorded on the disks by making a series of magnetic spots or *bits* in the ferrous oxide coating. The serial arrangement of bits forms letters, digits and special characters.

The recording area for a character is divided serially into three sections:

1. The zone section consists of the first two positions in the code pattern. The presence of a magnetized spot in both positions corresponds to a 12-zone punch in an IBM card. The presence of a magnetized spot in the first (0) position corresponds to a 0-zone in the card, and the presence of a spot in the second (X) position corresponds to an 11-zone punch.

2. The numerical section consists of four positions, which are serially assigned values of 1, 2, 4 and 8. Combinations of punches in this section correspond to numerical punches in the IBM card.

3. The check section consists of one position which receives a magnetic spot for those characters that would otherwise have an even number of spots. By filling this position with a magnetic spot for all characters that would otherwise be even, all characters are coded with an odd number of spots.

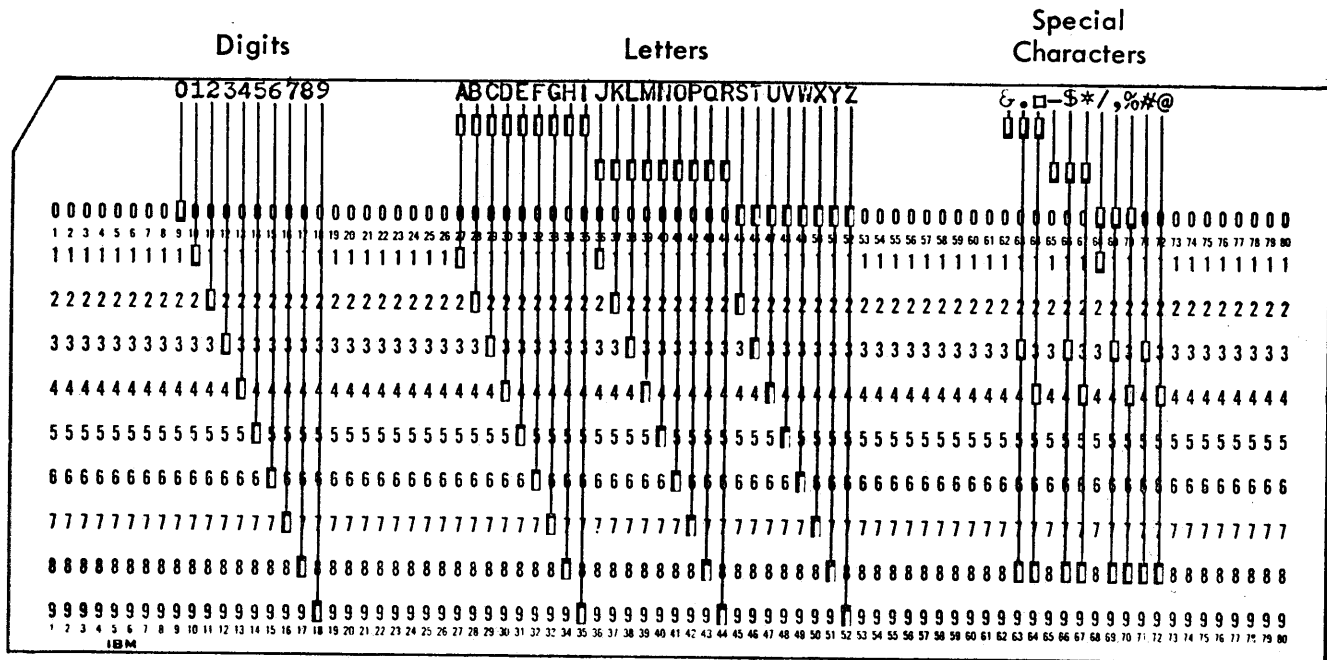

FIGURE 43. CHARACTER CODING IN IBM PUNCHED CARDS

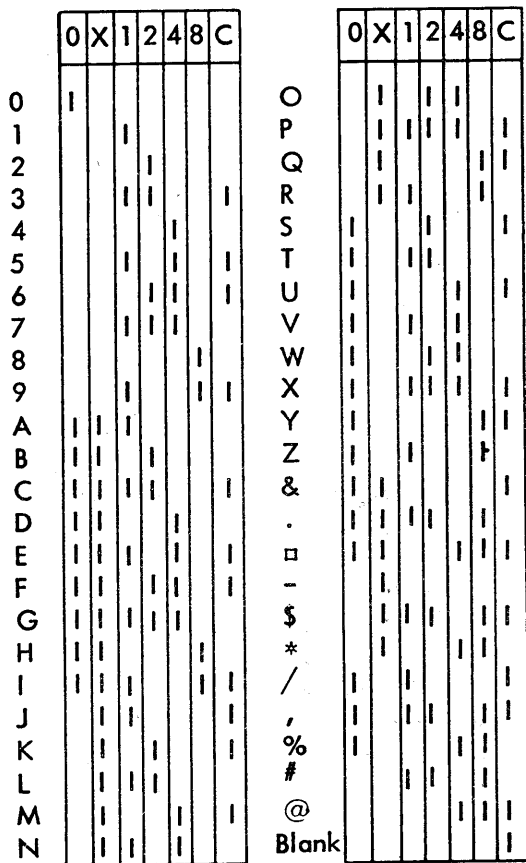

FIGURE 44. CHARACTER CODING, DISKS AND DRUM

As an example, the character J is coded on an IBM card with the combination of the 11-zone punch with the 1-digit punch. On the magnetic disk, the zone section is recorded with an X bit, and the numerical section has a bit recorded in the 1 position. Because an even number of bits results, the check position is filled with a magnetic spot to result in an odd number of bits (3) for the character. Similarly, the character T is coded by a combination of the 0 and 3 punches in an IBM card. On the disk it is recorded with a bit in the 0 position, bits in the 1 and 2 positions to represent 3, but no bit in the check position, because the code already has an odd number of bits.

The coding system shown in Figure 44 is used throughout the machine for magnetic recording on the disks and drum. As the information passes to and

from the magnetic core unit on each transfer instruction, every character is checked for an odd number of bits. This type of checking is called a *redundant-bit* check. If a character is found with an even number of bits, it is recognized as an error.

Checking

The 305 is equipped with check indicators that provide the operator with a check on the accuracy of the information being processed by the machine. Check lights are provided at the supervisory control station as follows:

- Read Check
- Feed Check
- Parity
- File error
- Clock

Read Check

In the card reader, as each card passes the first reading station (Figure 45) it is read, encoded into the 6-bit code used in the machine, and recorded on input track 1 on the processing drum. As the next card feed cycle begins, the characters on input track 1 are read off and transferred to input track 2, and check bit is added to any characters that would otherwise have an even number of bits. Input track 1 is erased, and the next card is recorded on it from first reading. Meanwhile, the first card is passing second reading, and this card is read again, re-coded, and checked against the original reading and coding. Any deviation between the two results stops the machine and turns on the read check light. The information in error will not have entered the system. If the two results are exactly the same, the input track is made available to the process unit. Restart procedures are covered under *Error Correction*.

Feed Check

If the reader fails to feed a card, the feed check light is turned on and the machine stops. The operator may determine the reason the card did not feed and restart the machine. Restart procedures are covered in a later section entitled *Error Correction*.

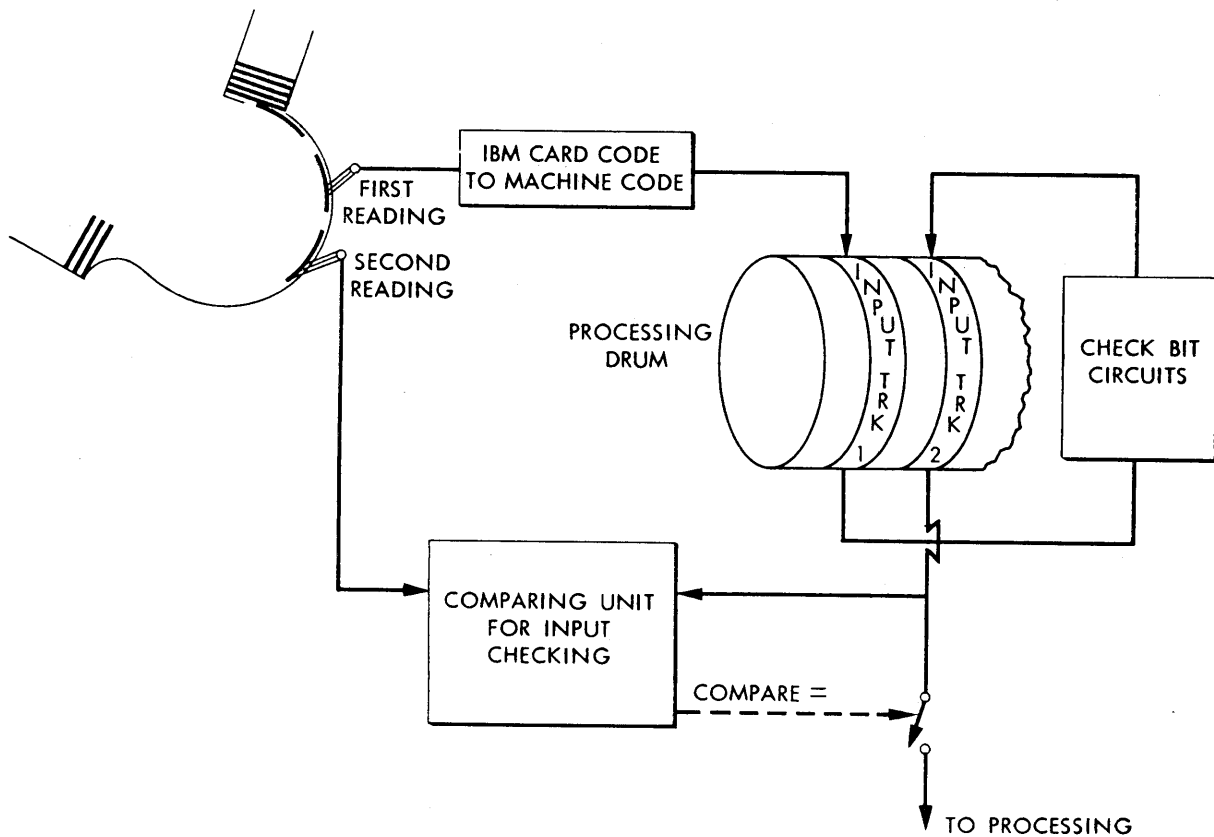

FIGURE 45. CHECKING OF INPUT CARD READING

Parity Check (Figure 46)

Each character that enters or leaves the magnetic-core unit is checked to insure that it contains an odd number of bits. Because all information transfers (except certain arithmetic operational transfers) take place through the magnetic-core unit, the machine will recognize an error whenever an inadmissible char-

acter is transferred. Any combination of bits that give an even count will stop the machine and turn on the parity check light. Restart procedures are covered under *Error Correction*.

Parity checks are also made on the coded program instructions entering the instruction register, and on all information as it is transferred from the output track to the printer or punch.

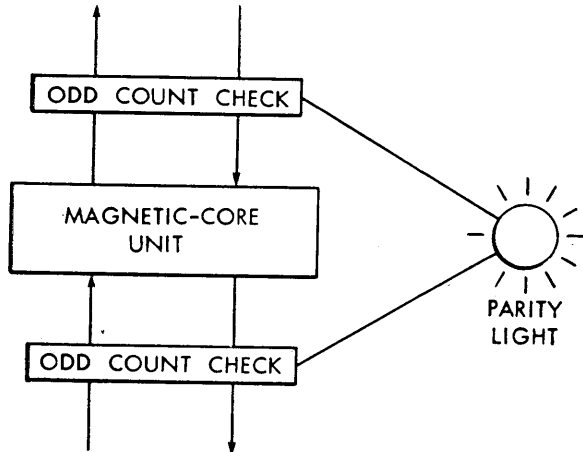

FIGURE 46. PARITY CHECK

File Error (Figure 47)

The file check is a check on the recording of information on the disks. Whenever a record is written in the disk storage, the machine automatically re-reads the same record into the core unit. Then the record is read back from the disk storage track and compared, character by character, with the re-reading of the record in the magnetic-core unit. A difference in comparison causes the file error light to be turned on and stops the machine.

If information is transferred from the accumulator track to the disk storage on a readout and reset instruction, a file error stop occurs, because the contents of the accumulator has been reset, and this will not compare with the information from the disks.

If the file interlock is not connected during program testing, there will be a file check light on every write operation, because the contents of the disk track is not changed. The disk track, therefore, will not compare with the sending track. This also serves to prevent running the actual application without plugging the file interlock.

File error correction procedures are covered under *Error Correction*.

Clock

The machine makes an automatic check to determine that the timing control circuits are operating correctly. If these circuits are out of time, the clock light is turned on, and the machine stops. Clock error correction procedures are covered under *Error Correction*.

370 Printer Output Check

As each character is printed from the output track, the 370 makes a check that the print unit is set up

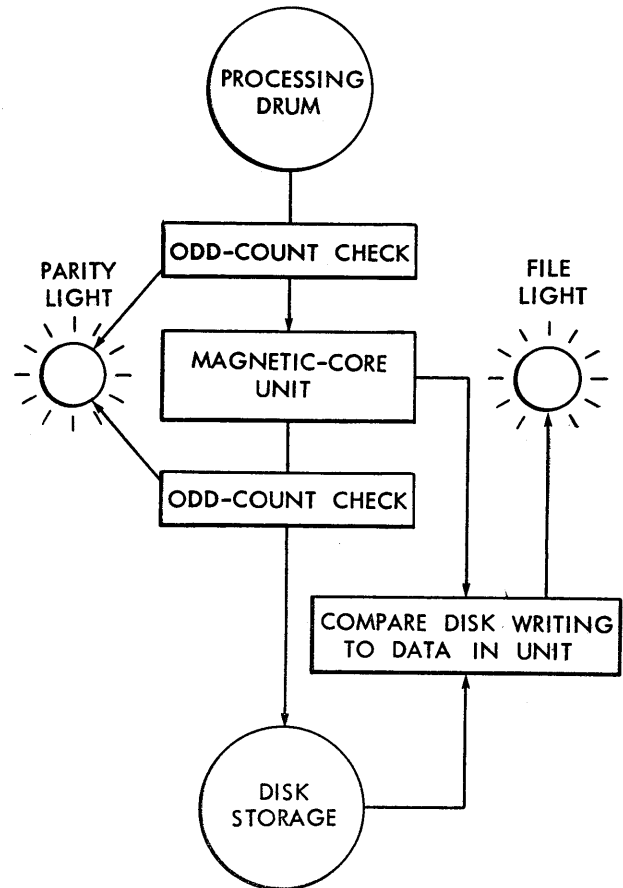

FIGURE 47. FILE ERROR CHECK

correctly for printing the desired character. If a wrong setup should occur, the 370 output check light will be turned on. After the line is printed, the machine will either stop, print a Δ , or both, depending upon control panel wiring. The output check light will also be turned on if a parity error occurs between the output track and the printer.

323 Punch Check

Associated with the 323 Punch are three checking features: feed check, double punch and blank column, and parity. Any misfeed in the punch unit causes the feed check light to be on. It is also on when the hopper is empty or when the stacker is full. A double-punch blank-column light will be on when either a double-punch or blank-column error is detected, if the error exit is wired to stop on the punch control panel. The parity light will be on if any character being transferred from the output track to the punch (including those positions not being punched) fails to pass the parity checking requirements.

380 CONSOLE

THE CONSOLE (Figure 48) provides manual or semi-automatic control over the machine. It contains an indicator panel, keyboard, card reader, and a typewriter with its associated control panel. It allows an operator to investigate the source of an error, and to manually restore operation. Inquiries can be made requesting information stored on the disks or processing drum. In addition, it provides a convenient method for testing new programs.

Control Keys

The following control keys are located on the console.

Master Power Off. This switch is located under the console clock. When it is used, all power is removed immediately. It is for emergency purposes and should not be used as part of the normal power removal procedure.

Power Off (Figure 49). When this key is depressed, the power is removed from the machine; however, the blowers will remain in operation for a short pe-

riod of time. Use this key instead of the master power-off to remove power from the system in a normal manner.

DC Off. Depressing this key removes the dc power from the machine. This is desirable if the machine is to remain idle for an extended period of time.

Power On. By depressing this key, ac power is applied to the machine. It also restores dc power if the dc off key has been previously depressed.

Reset. When the reset key is depressed, the processing unit is placed in a ready condition. It also resets clock errors. It should not be used to reset parity error indications and should not be depressed while a program is running.

Reader Stop. The reader stop key stops the card reader immediately. The program or process unit continues running until a reference is made to the input track; then, the processing unit stops. The reader stop key is also used to remove the reader from a ready status so that the non-process runout key can be used to run cards out of the card reader without processing these cards.

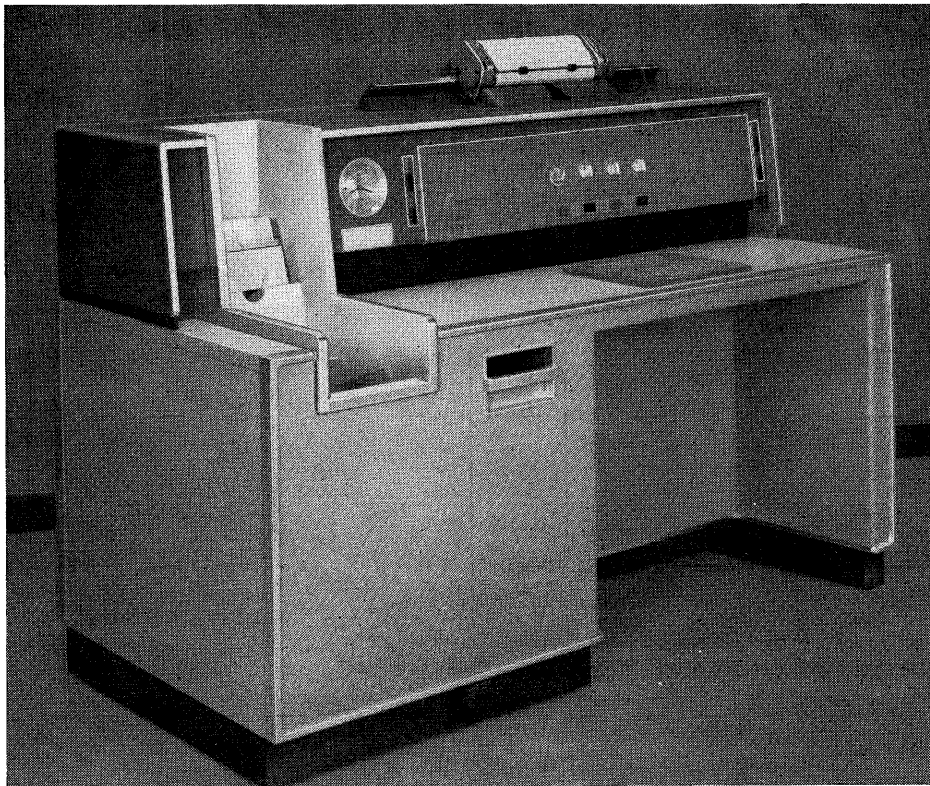

FIGURE 48. 380 CONSOLE

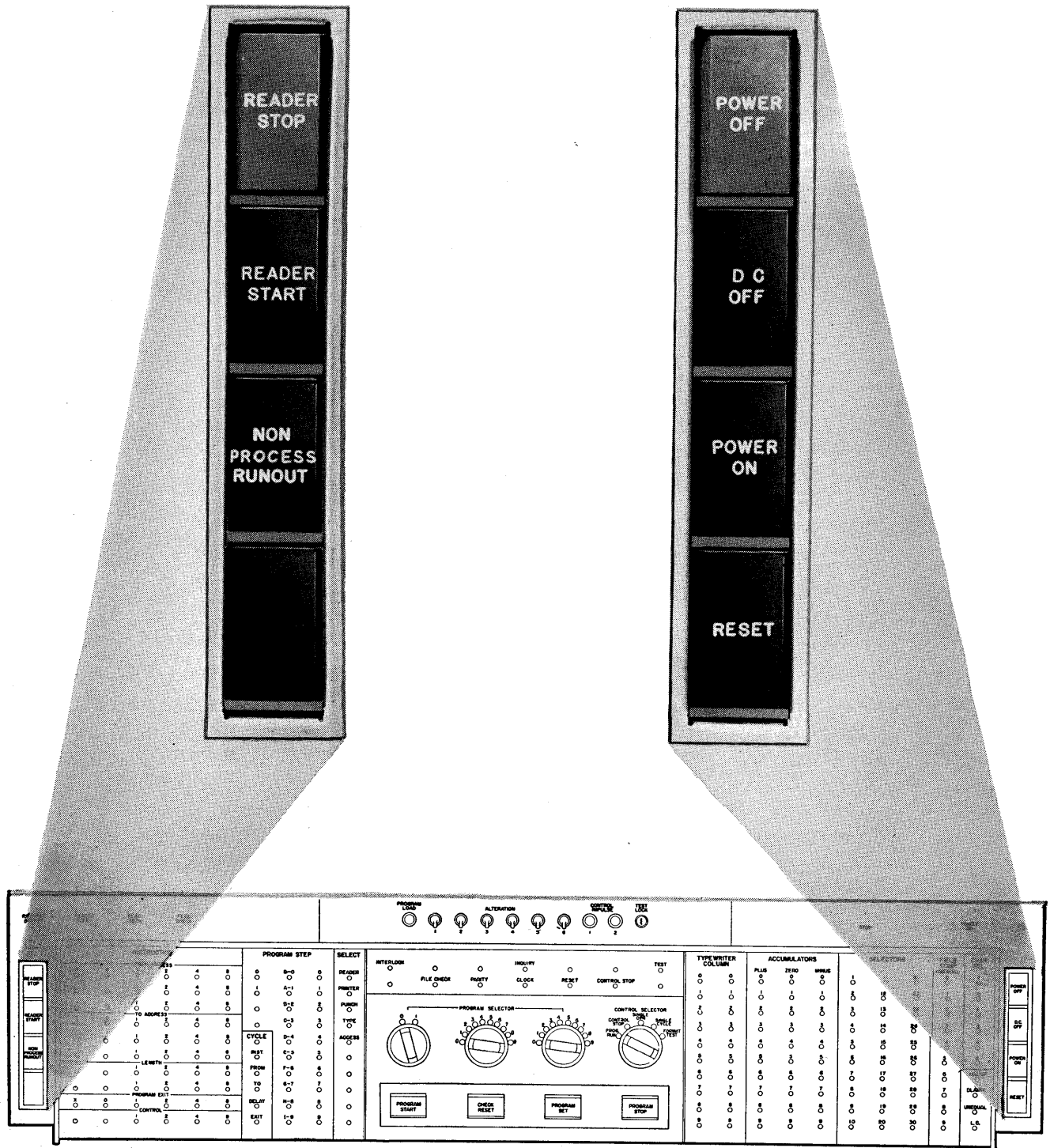

FIGURE 49. POWER, RESET AND READER KEYS

Reader Start. Depressing this key causes the reader to run cards into or out of the card reader. In addition, it restores the reader to a ready condition if the reader stop key has been previously depressed.

On the initial run-in of cards into the machine (provided the processing unit is in a reset condition), depression of this key causes the following: three cards are fed; the first card is checked and made available to the processing unit if all checks are satisfied;

the start hub on the processing control panel emits an impulse.

Non-Process Runout. When this key is depressed, cards feed out of the card reader without being processed if the hopper is empty. It is generally used after a read check or a feed check stop. The non-process runout key is inactive unless the reader stop key was previously depressed.

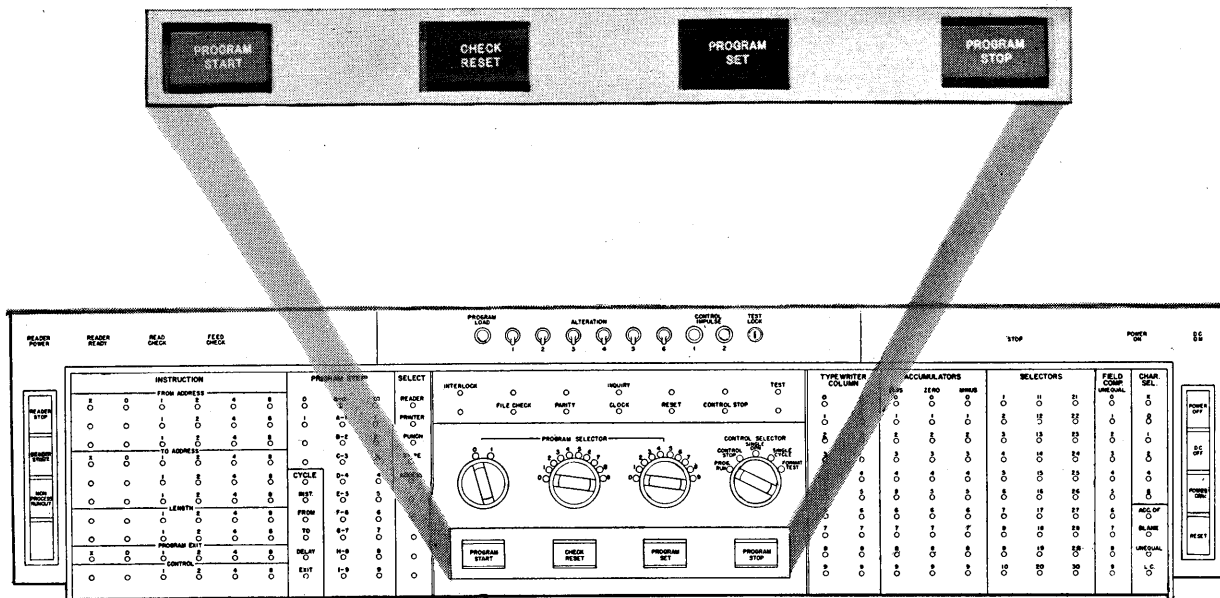

FIGURE 50. PROGRAM KEYS

Program Start (Figure 50). This key starts the program at the next detail operating cycle if the program is stopped. After the program stops, the function of this key will depend upon the mode of operation of the machine. Examples of its use are covered under *Control Selector*, *Program Selector*, *Program Set*, and *Examples of the Use of the Console*.

Check Reset. This key resets parity errors. Depressing it restores the error detecting circuits and leaves the machine ready to repeat the instruction on which the error was made. Operation can be resumed after depressing the program start key. Check reset should not be depressed while a program is running.

Program Set. Depressing this key sets the program to the operating step set on the program selector switches. The instruction set up in this manner will not be executed until the program start key is depressed. Examples of its use are given in a later section.

Program Stop. Depressing this key stops the machine prior to the execution of the next program step. The next program step is then ready to be executed as soon as the program start key is depressed.

Control Switches

The following control switches are located on the console.

Alteration Switches (Figure 51). Six toggle switches are provided so that control panel operations may be

altered by the switches without removing the control panel from the machine. The switches are connected to control panel hubs in the processing unit, and are represented in the same manner (T-N-C) as selectors.

Control Selector Switch. This is a five-position switch that sets the mode of operation for the machine. This switch may be turned while the machine is running to select a different mode of operation. The five modes of operation are:

1. *Program run* allows the machine to proceed automatically. The operation is under complete control of the process control panel and the stored program.

2. *Control stop* causes the machine to stop prior to the execution of the program that has been set up on the program selector switches. For example, if program 159 is set up on the program selectors, the machine will stop just prior to the execution of program step 159.

3. *Single operation* allows the machine to proceed through one complete instruction each time the program start key is depressed.

4. *Single cycle* allows the operator to step through each program step, one cycle at a time. For example, when the machine is in a single-cycle mode of operation, one depression of the program start key executes the INSTRUCTION cycle and stop prior to the execution of the FROM cycle. Another depression executes the FROM cycle and stops before the TO cycle.

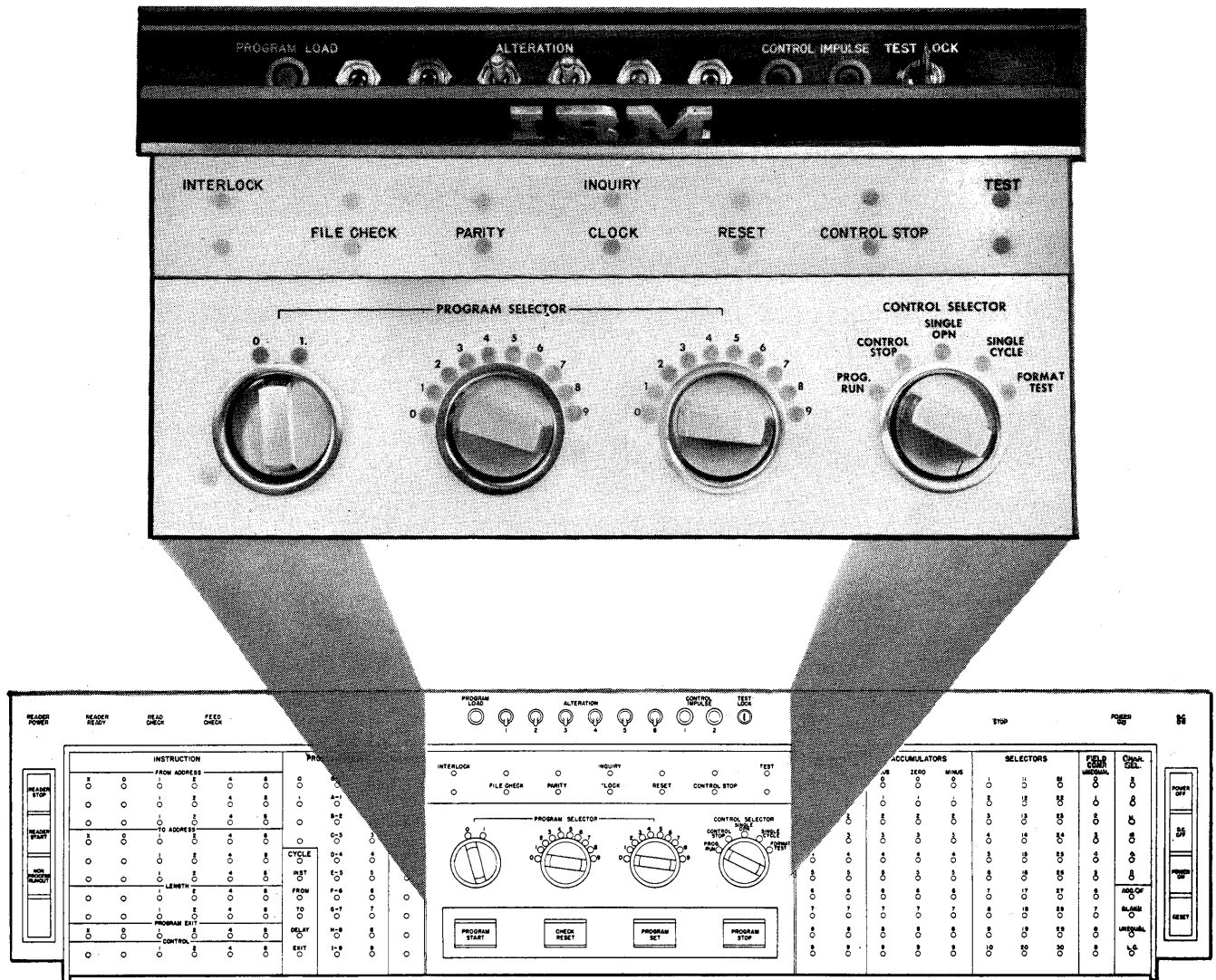

FIGURE 51. CONTROL SWITCHES, BUTTONS, AND LIGHTS

5. *Format test* allows the program start key to control the mode of operation so that the typewriter control panel program may be stepped through one cycle at a time.

Program Selector Switches. Three dial switches are provided so that any desired program number may be set up by the operator. The switches correspond to the hundreds, tens, and units positions of the program. Depressing the program set key sets the program counter to the step shown on the switches. When the control selector switch is set to CONTROL STOP, the program stops on the step indicated by the switches.

Control Buttons

The following control buttons (Figure 51) are located under a cover at the top of the console indicator panel.

Control Impulse. Two pushbuttons are provided. They cause impulses to be emitted from two hubs labeled *CI* on the process control panel. These impulses are normally used to pick up or drop out selectors and latch devices.

Program Load. Program load starts the set up of a new program on the machine. Before this device is used, the machine must be in a reset condition and program set up cards must be in the reader hopper.

When these conditions are satisfied, depressing this button causes the following:

1. cards feed into the reader,
2. after the first setup card has been checked and becomes available to the processing unit, the card information will be automatically copied onto program track I,
3. an impulse will be emitted from the COPY OUT hub on the process control panel which may be used to select the beginning program step of the setup routine on track I.

Test Lock (Figure 51)

Under normal operation (test lock off), the keyboard may be used only for making manual inquiries and correcting redundancy errors. No manual changes to the processing tracks or to the disk records are possible when this switch is off. When the switch is on as during program testing, it is only possible to change data on the tracks of the processing drum; normal file addresses are not available.

If information in the disk storage must be changed manually, the desired record should be transferred to the typewriter track by an inquiry operation. Then the key is turned on (to place the machine in the manual mode of instruction), and the information on

the typewriter track may be rewritten or corrected. After the corrections have been made, the test lock is turned off, and the machine is started at an instruction that will transfer the record on the typewriter track back to the disk. This procedure is designed so that miskeying will not transfer information to an incorrect disk address.

Indicator Lights

Power On (Figure 52). This light is on when ac power is supplied to the machine after depressing the power-on key.

DC On. This indicator light is on when dc power is being supplied to the machine circuits.

Stop. This light will be on after a time delay any time the machine stops. It is an indication to the operator that processing has been halted, but does not indicate the exact cause for stopping. In the event of an error, the cause will be shown on one or more of the other indicator lights.

Reader Power. This light is on when the reader has power supplied.

Reader Ready. The reader ready light will come on when the reader is under the control of the process unit. That is, no recode or card feed errors have been detected, and a checked card has been made available to the process unit.

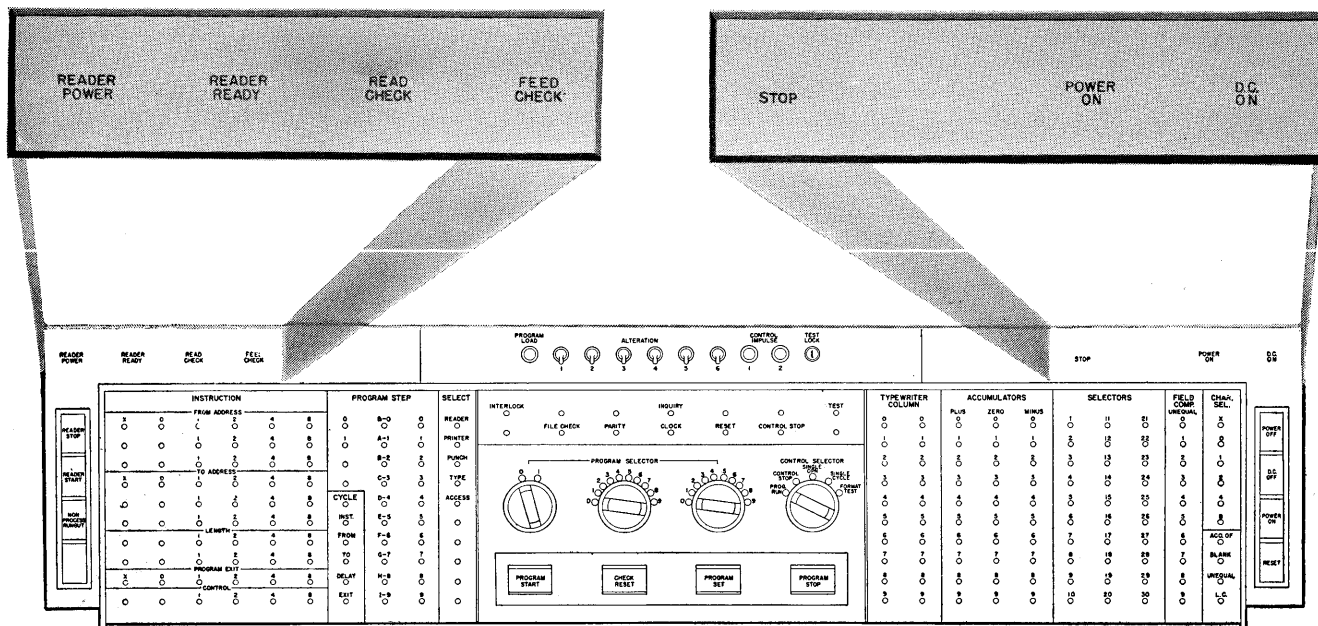

FIGURE 52. POWER, MACHINE STOP, AND READER LIGHTS

INSTRUCTION					PROGRAM STEP			
		FROM ADDRESS						
X	0	1	2	4	8	0	&0	0
		1	2	4	8	1	A-1	1
		1	2	4	8		B-2	2
		TO ADDRESS						
X	0	1	2	4	8		C-3	3
		1	2	4	8		D-4	4
		1	2	4	8		E-5	5
		LENGTH						
		1	2	4	8		F-6	6
		1	2	4	8		G-7	7
		PROGRAM EXIT						
X	0	1	2	4	8		H-8	8
		CONTROL						
		1	2	4	8		I-9	9

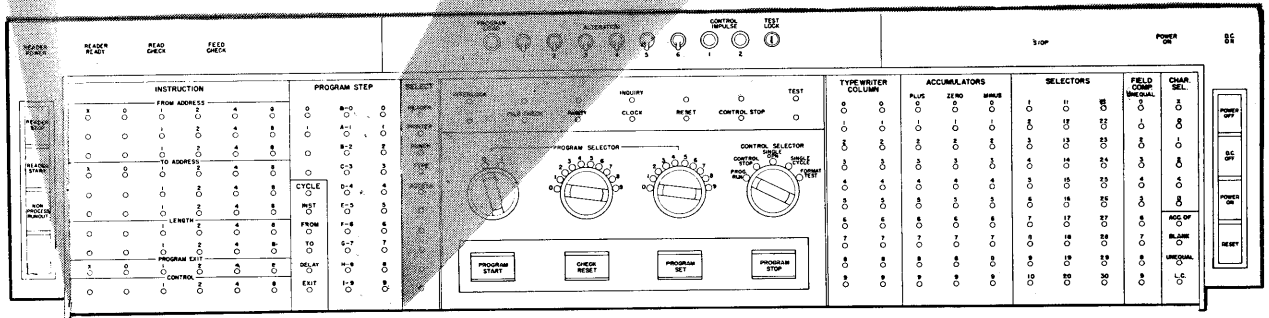

FIGURE 53. PROGRAM INSTRUCTION LIGHTS

Read Check. This light comes on when a comparing error is detected in the card reader. A failure either to read correctly or recode properly will stop the reader immediately so that incorrect information will not be transferred to the processing unit. Restart procedures are explained in a later section, *Start-Stop Procedures*.

Feed Check. This light signifies a misfeed in the card reader. Restart procedures are explained in a later section, *Error Correction*.

Program Step Indicators (Figure 53). This bank of lights shows the number of the program step that is being executed. For example, program step number 127 would have the 1-B2-7 lights glowing. It can further be seen that program step 127 is actually on

track B. The alphabetic track references are used when the program steps illustrated are 100 through 199. For steps below 100, the tens position of the step number defines the program track.

Instruction Lights. Any instruction, as it is being executed, will appear at this bank of lights in coded form. When the machine is being operated in the single-cycle or single-operation mode, these lights may be investigated to determine if the instruction is correct. The FROM address, TO address, and the PROGRAM EXIT are represented in machine code, that is, an A would light the X, 0, and 1 neons. The LENGTH, and CONTROL banks are in straight binary form, that is, a 5 would light the 1 and 4 neons, etc.

Cycle. These five lights show the cycle of the instruction that will be executed next unless an error has occurred. If an error is indicated, the lights show the cycle on which the error occurred. When the machine is in a single-cycle mode of operation, an operator may step through an instruction one cycle at a time using these lights as a convenient means of keeping track of each cycle of the instruction. In order of occurrence, the cycles are INSTRUCTION, FROM, TO, DELAY and EXIT. DELAY and EXIT occur only when the ninth position of an instruction contains either a digit, special character, or an alphabetic character, or when an address is sent to the address register.

Typewriter Column (Figure 54). These lights indicate the column of the typewriter track (Q) that is to be written on, or the Q-track position to be typed if the typewriter is writing a record.

Accumulator Signs. The condition of each accumulator is represented here whether it is plus, zero, or minus. The light will stay on until the condition of the accumulator is changed through programming. At the completion of a multiplication, the signs of accumulators 0 and 1 are always plus.

Selectors. An indicator light is associated with each selector. When the selector is transferred, the light is turned on. It will remain on until the selector is dropped out.

Field Compare. Each field-compare light will come on if its respective field is unequal as a result of a field comparison. The light will remain on until another comparison changes its status.

Character Selector. When a character is sent to the character selector, these lights indicate its identity in coded form. The lights will remain the same until another character is transferred into the character selector.

Accumulator Overflow. If this light is on, one of the accumulators has had an overflow. It will remain on until dropped out by control panel wiring.

Blank. The machine monitors all transmissions of data through the magnetic-core unit. If the last transmission was either blank or zero, the light will glow. The status is indicated anew as a result of each data transfer; therefore, reference to the blank transfer device on the process control panel must be made immediately following a data transfer instruction.

Unequal. This light will come on if the last programmed compare (using the 1 or 3 control code) was unequal. It will stay on until another comparison changes it.

LC. When this light glows, it signifies to the operator that the last card has been processed and the reader has run out of cards.

TYPEWRITER COLUMN		ACCUMULATORS			SELECTORS			FIELD COMP. UNEQUAL	CHAR SEL.
0	0	PLUS 0	ZERO 0	MINUS 0	1	11	21	0	X
1	1	1	1	1	2	12	22	1	0
2	2	2	2	2	3	13	23	2	1
3	3	3	3	3	4	14	24	3	2
4	4	4	4	4	5	15	25	4	4
5	5	5	5	5	6	16	26	5	8
6	6	6	6	6	7	17	27	6	ACC. OF
7	7	7	7	7	8	18	28	7	BLANK
8	8	8	8	8	9	19	29	8	UNEQUAL
9	9	9	9	9	10	20	30	9	L. C.

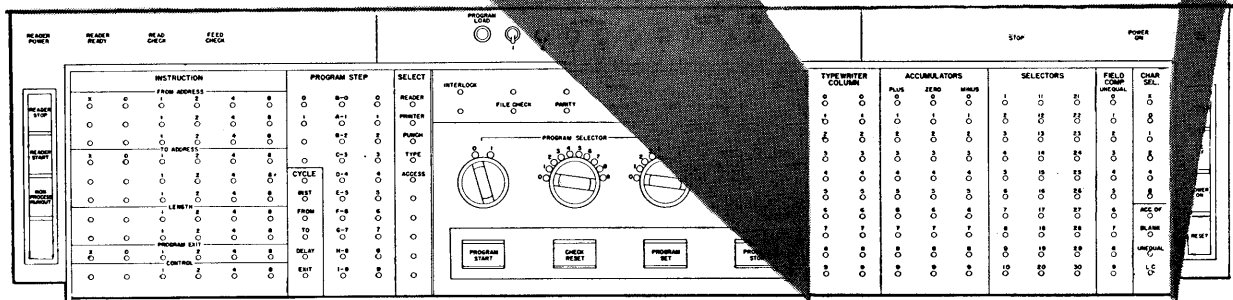

FIGURE 54. TYPEWRITER AND PROCESS CONTROL PANEL STATUS LIGHTS

Select (Figure 55). A row of lights are provided to indicate when a particular device has been selected. As each unit is selected, the associated light will come on and will remain on throughout the operation. If the selected unit should fail to operate, the light will stay on and the program will stop the next time that the unit is referred to by programming. This bank of lights includes reader, printer, punch, typewriter and access.

Interlock. The interlock light will be turned on whenever processing has been stopped due to a failure of a selected unit to function properly. To determine which unit is causing the interlock stop, the operator can refer to the bank of lights labelled *Select*.

Inquiry. This light will glow when the machine will allow a manual inquiry. Manual inquiries are covered in a later section, *Inquiries*.

Test. This light will glow when the test lock is on.

File Check. Each time a record is written into the disk storage, it is automatically read back and compared against the source record. If the record is stored correctly, the machine will proceed with its operation. However, if the readback from the disk does not compare, the machine will stop and the file light will be turned on. Correction procedures are covered in a later section, *Error Correction*.

Parity. This light is turned on whenever the machine detects an inadmissible code during a transfer. The machine will stop. Restart procedures are covered in a later section, *Error Correction*.

Clock. The machine makes an internal check to insure that the timing circuits are operating properly. If these circuits fail, the machine will stop and the clock light will come on indicating a possible error. The light may be turned off by depressing the reset key. Techniques for clock error correction are covered in a later section, *Error Correction*.

Reset. This light will be turned on when the machine stops because of depression of the reset key, or any time the hubs labeled *Reset Stop* on the process control panel are impulsed.

Control Stop. This light will come on and the machine will stop when the hubs labeled *Stop* on the process control panel are impulsed, when the control selector switch is placed on SINGLE OPN. or SINGLE CYCLE, or when the machine stops after a control stop. Operation may be resumed by depressing the program start key,

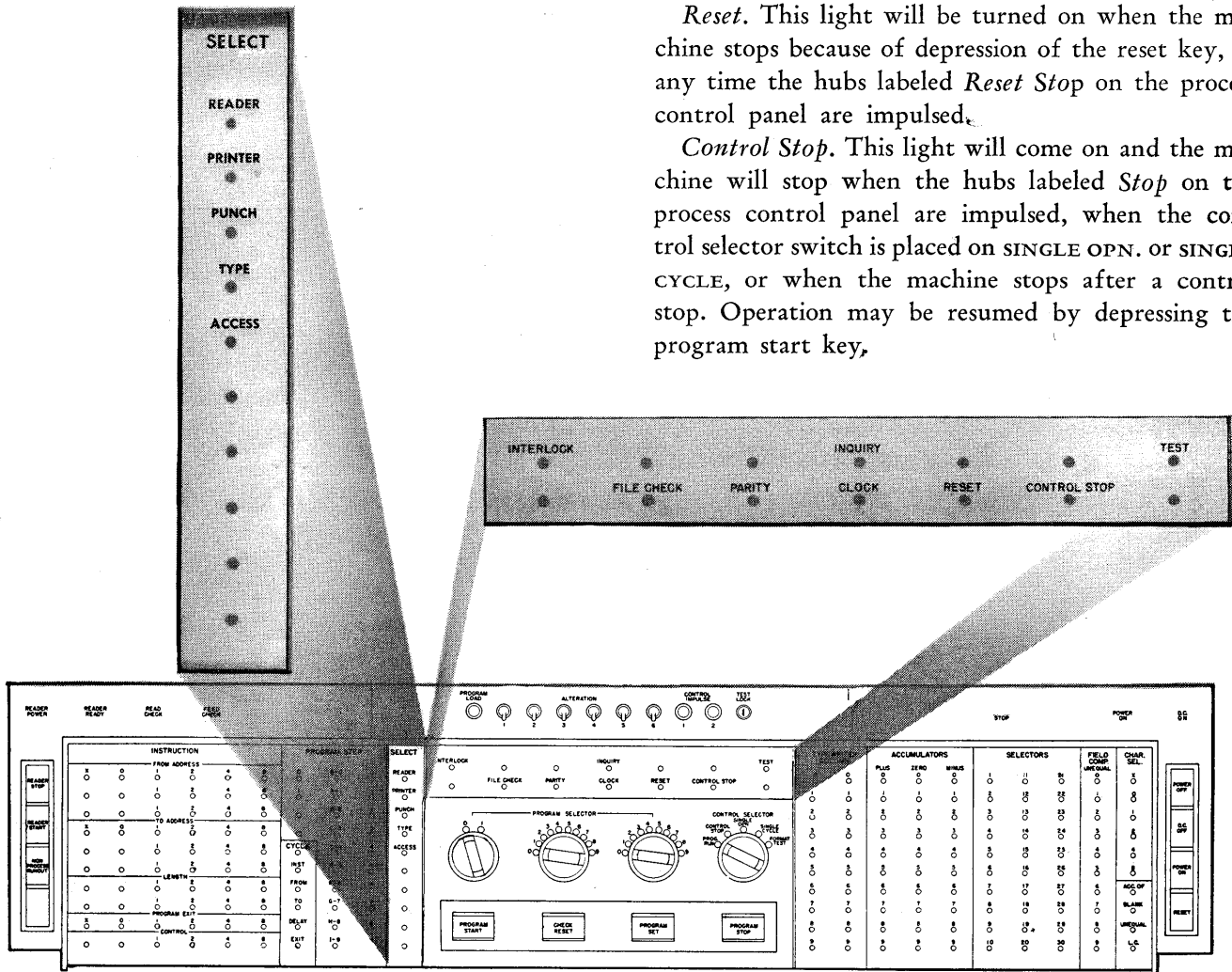

FIGURE 55. ERROR INDICATION AND CONTROL LIGHTS

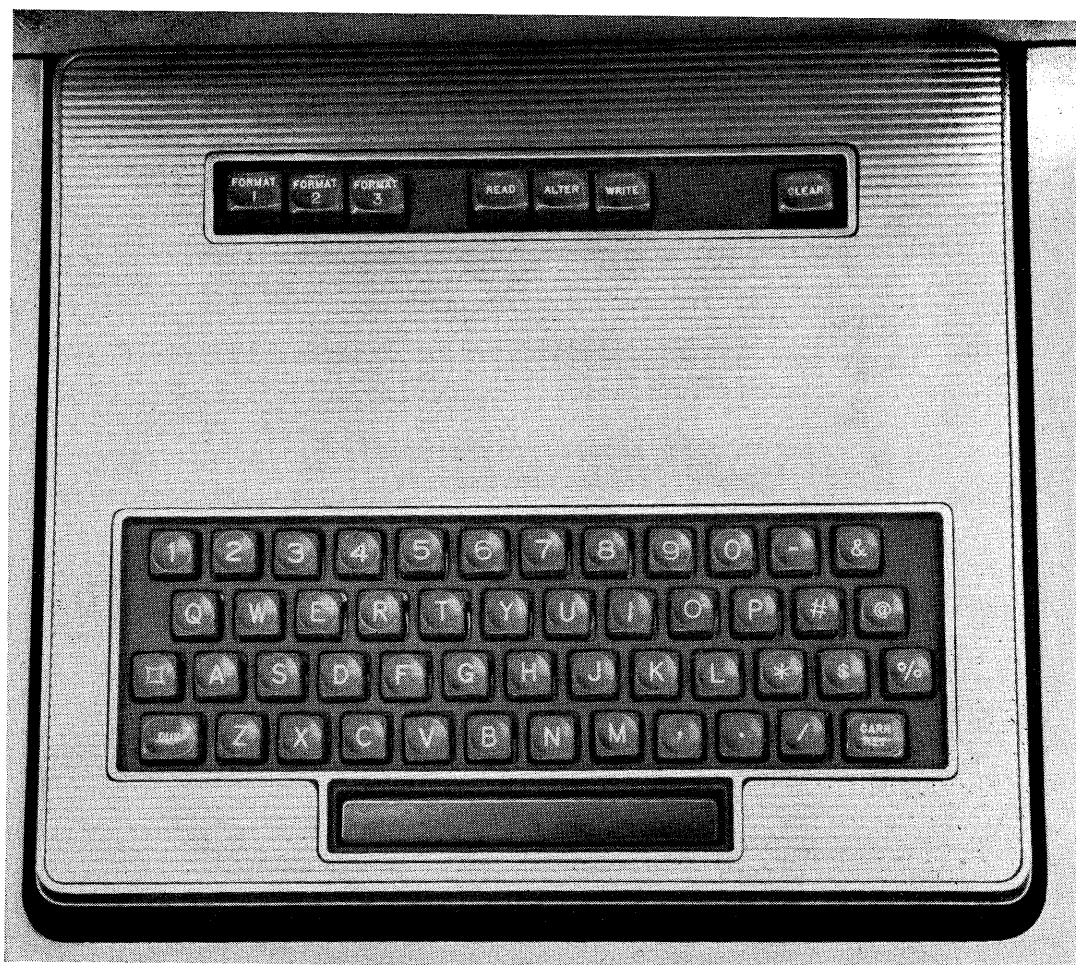

FIGURE 56. CONSOLE KEYBOARD

Keyboard Functions

The keyboard (Figure 56) associated with the console is similar to that found on a 24 Card Punch. It is used to make manual inquiries, and to write or make corrections on the processing drum tracks. It cannot be directly used to change disk storage records.

Format Keys. There are three format keys: 1, 2, and 3. When any one of these keys is depressed, it is a signal to the machine that the operator wishes to make a manual inquiry to the file. With each key there is a corresponding control panel hub on the typewriter control panel. By appropriate wiring, different document formats are possible when making manual inquiries. For example, depressing format 1 can initiate a typewriter format routine which may be entirely different from the format called for when format 2 is depressed. Manual inquiry procedures are explained in a later section, *Inquiries*.

Read Key. Depressing this key will condition the

machine so that a record can be typed when the appropriate track is called for. It should not be depressed while the program is running or the machine is interlocked.

Alter Key. Depressing this key (if the test lock is on) will condition the machine so that information can be recorded on the typewriter track from the keyboard. If the test lock is off, depressing the key will cause the typewriter to seek invalid characters on the Q-track and stop for their correction. It should not be depressed while the machine is processing or interlocked.

Write Key. Depressing this key will condition the machine so that data may be transferred from the typewriter track to some other drum track. If the test lock is off, data on the typewriter track can only be returned to the track from which it originated. When the test lock is on, the operator must depress a track key (one of the character keys) to send the Q-track information to the desired track location.

It is not possible to transfer data directly to disk storage. The machine should not be interlocked, and processing should be stopped before depressing this key.

Clear Key. When this key is depressed, typing will stop; the carriage will return; and the keyboard circuitry will be reset to a *ready* condition.

Character Keys. These keys are used for recording data on the typewriter track or specifying a track address.

Dup Key (Duplicate Key). Depressing this key will automatically cause the typewriter to type the con-

tents of the Q-track if the test lock is on and the alter key has been previously depressed. This is a *write* condition. This key has no function if the test lock is off.

CR. Depressing this key will cause the carriage to return.

Space Bar. This key writes spaces on the Q-track. If the test lock is on, it can be used to write space bits on the typewriter track either one at a time if the alter switch has been previously depressed, or it will clear the entire typewriter track if the read key was depressed just prior to using the space bar.

EXAMPLES OF CONSOLE OPERATION

THE following examples of the use of the console are presented as an aid to the operator. The examples include start and stop procedures, inquiries, error correction, drum track alterations, and testing procedures.

START-STOP PROCEDURES

Starting the Machine After a Power-off Condition

The following procedure may be used to start the machine after the power has been turned off:

1. Depress the power-on key at the console to deliver power to all units (printer and punch power switches may be left on). Then depress the console reset key.
2. Depress the printer start key. Check to see that the printer ready light comes on to indicate that the printer is in a ready condition.
3. Hold the punch start key down until cards stop feeding and the ready light glows.
4. Depress any control impulse buttons that are pertinent to the program.
5. Place the control selector to the desired mode of operation.
6. Place the desired data or program load cards in the reader hopper.
7. If a new program is being loaded, depress the program load button. This will initiate card feeding, and the first program card will be automatically copied on program track I. An impulse will be emitted from the COPY-OUT hub on the process control panel which may be wired to start the beginning program step.

If the program is already in the machine, depress the reader start key. This will feed cards and cause the START hub on the process control panel to emit, and the beginning program step may be selected through control panel wiring.

Restarting the Same Job

It is only necessary to depress the reader start key to restart the same job. This will feed cards and start processing provided the machine is in a reset condition. The machine will be reset if the last card routine was terminated by impulsing the RESET STOP hub on the process control panel, or the reset key was depressed.

Starting or Stopping at a Specific Program Step

To start

1. Set the program selector switches to the desired program number.
2. Set the control selector switch to the desired mode of operation—run, single operation, etc.
3. Depress the program set key.
4. Depress program start.

To stop

1. Set the program selector switch to the desired program number.
2. Set the control selector switch to CONTROL STOP. The program will stop before executing the FROM cycle, that is, the program step will be set up, but will not have been executed.

INQUIRIES

Manual Inquiry — File Information

To make a manual inquiry requesting file information:

1. The test lock is off (locked).
2. Control selector switch is set on RUN.
3. Depress the desired format key.
4. After the inquiry light on the indicator panel comes on, key in the appropriate file address. This will cause the machine to type the record automatically.

Manual Inquiry — Drum Information

To investigate the information on one of the drum tracks:

1. The test lock may be either on or off.
2. Control selector switch is set on RUN.
3. The machine must not be processing or interlocked.
4. Depress the read key.
5. Depress one of the character keys on the keyboard. Character key A would call out track A; numeric key 2 would call out track 2; hyphen (-) would call out the core buffer, etc.

ERROR CORRECTION

Parity Check

An improper character transfer within the processing unit will cause a parity check stop. The operator should investigate the following:

1. If the parity check occurred on the INSTRUCTION cycle the machine will stop with the INSTRUCTION cycle light on. The operator may attempt the transfer again by depressing check reset and then program start. This is possible because no information has actually transferred, and the records in the machine have not been affected.

2. If the parity check occurred on the FROM cycle, the machine will stop with the FROM cycle light on. Depressing check reset and program start may be all that is necessary unless an accumulator read-out and reset instruction is involved. If read-out and reset have occurred, the accumulator has been reset to zero; however, the accumulator data is retained in the core buffer. This data should be saved immediately. Depress check reset, and make an inquiry of the core buffer using the track address hyphen (-). After investigation of the core buffer—if it is decided that the contents of the accumulator cannot be reconstructed—it may be necessary to restart the program at some previous instruction so that the accumulation can be built up again.

If an error persists on a track to track transfer, it is an indication that the source data is incorrect. A method for correcting invalid characters on the drum is given in a later section.

3. If the parity check occurred on the TO cycle, the machine will stop with the TO cycle light on. Depressing check reset and program start is all that is necessary unless a read-in to an accumulator is involved. If a read-in has occurred, the data should be saved immediately. Depress check reset, and make an inquiry of the core buffer using the track address hyphen (-). It may be possible to correct the error by comparing the accumulator data with the buffer information and the source record. However, if this is not possible, the program should be restarted at some previous program step where the accumulator is reset and the accumulation can be started over again.

Clock Error

If any phase of the machine timing gets out of step, a clock error will occur. To restart:

1. Make a note of the program step and cycle involved.
2. Depress the reset key, not the check-reset key.
3. If the error occurred on the INSTRUCTION cycle,

set the program selector switches to the program involved, depress program set, and then restart by depressing program start.

4. If the error occurred on the FROM cycle, it may be possible to use the same procedure as just outlined. However, if a read-out and reset of an accumulator is involved, the program should be restarted at some previous instruction so that the accumulator may be reconstructed.

5. If the error occurred on the TO cycle, it is possible that data was written in the wrong location of the receiving track. This should be investigated. If no damage occurred, the program step can be repeated by a program set and then depressing the program start key. However, if a read-in to an accumulator is involved, the program should be restarted at a point where the accumulator is reset and the accumulation can begin again.

File Check

When a file check light appears, it is an indication that the record that has just been stored on the disk does not agree with the source information on the drum. The operator may attempt the transfer again by depressing the check reset key and then the program start key. An accumulator read-out and reset to the file is an invalid instruction and will always cause a file check.

Read Check Stop

This stop indicates an error in reading or recoding of the input card.

To restart

1. Depress reader stop.
2. Remove the cards from the feed hopper.
3. Depress non-process runout to clear the feed stations.

4. The last three cards to run out of the machine were not processed; therefore, place these three cards in front of the remaining cards that are to be processed. Then depress the reader start key to run cards into the reader.

Feed Check Stop

This stop signifies a misfeed in the card reader. A check is made as the cards leave and arrive at each feed station. Therefore, any jam should affect only one card that has not been processed.

To restart

1. Depress reader stop.
2. Remove the cards from the feed hopper.
3. Remove any jammed cards from the feed.
4. Run the remaining cards out by depressing the non-process runout key.
5. Restart by placing the last three cards (two cards if the card failed to feed from the feed hopper into the feed unit) in front of the remaining cards that are to be processed. Then depress the reader start key to run the cards in.

**Investigating an Interlocked Track
(Input or Output)**

1. Determine if the interlock is due to running out of cards or paper. If so, replenish and depress the corresponding input or output start key.
2. If the interlock is due to an input or output error condition;
 - a. Depress the console check reset key to drop out the interlocked instruction.
 - b. Proceed through a normal track investigation procedure.
 - c. Depress the check reset key on the interlocked input or output device.
 - d. Depress the console program start key to resume operation.

Correcting Invalid Characters

If a parity check persists on the FROM cycle, it may indicate an invalid character on the drum or file. To correct this condition:

1. The test lock should be off.
2. Depress check reset. This places the keyboard in the proper mode for making a track investigation.
3. Depress the read key.
4. Depress the character key that corresponds to the desired track; character key R will call out the file. This will initiate the typing of the track and cause the source track address to be remembered. Any invalid character will be automatically underlined as it is typed.
5. After the full track has been typed and the carriage has returned, depress the alter key. This will cause the typewriter to space across and stop under the first invalid character.

6. Manually type the correct character.
7. After the last correction has been made, depress the clear key.
8. Depress the write key. This will cause transfer circuits to refer to the track address stored in step 4 and cause corrected data to be transferred back to the specific source track.

ALTERATIONS TO DRUM TRACKS**Altering Part of the Information on a Drum Track**

To alter part of a drum track:

1. The test lock must be on.
2. Depress the read key.
3. Select the proper track by depressing the corresponding character key. The machine will automatically type out the entire track.
4. Depress the alter key to place the keyboard in a condition to type on the Q-track.
5. Duplicate the track information onto the typewriter track by holding down the DUP key. Duplicate up to the position to be changed.
6. Manually type the new information.
7. Depress the clear key after all corrections have been completed.
8. Depress the write key.
9. Depress any desired track key except R (file record). This will transfer the information that has been typed to the selected drum track.

Altering a Complete Drum Track

To alter a complete drum track, proceed as follows:

1. The test lock must be on.
2. Clear the Q-track. This may be accomplished by depressing the read key, the space bar, and the clear key in this order.
3. Depress the alter key to place the keyboard in a condition to type on the Q-track.
4. Type the desired information.
5. Depress the clear key if you are typing less than 100 characters.
6. Depress the write key.
7. Select the desired track by depressing the corresponding character key. This will transfer the record to the selected track.

TESTING PROCEDURES

Testing Typewriter Control Panel Formats

Either manual inquiry or document printing formats may be tested one step at a time. The format 1, 2, and 3 control panel hubs initiate the starting impulse for manual inquiries, while document printing programs are started by the type hub impulse which signals that the process unit has requested a typing operation.

To test

1. Manual-inquiry format

- a. The machine must be in a reset condition.
- b. Place the selector control switch on **FORMAT TEST**.
- c. Depress the appropriate format key (1, 2, or 3).
- d. Key in the desired file address.
- e. Depress the program start key one time for each cycle of operation on the typewriter control panel program. This will initiate typed characters, spaces, tabulations, carriage returns, etc., depending upon the wired program.

2. Document-printing format

- a. Reset the process unit.
- b. The test record must be on the typewriter track.
- c. Place the selector control switch on **FORMAT TEST**.
- d. Depress the program start key one time for each cycle of operation on the typewriter control panel program.

Program Testing

The following procedures may be useful when testing a new program. Method 1 will execute a program one step at a time; method 2 will execute several program steps or a complete routine before stopping.

METHOD 1

1. The test lock should be off.
2. The file interlock switch on the process control panel should not be plugged. By leaving this switch unplugged, it is impossible to destroy a file record.
3. Place the program selector switches so that they correspond to the first program that is to be executed, and place the control selector on **CONTROL STOP**.

4. Place program load cards in the machine, and proceed through a normal program load routine.

5. After the processing unit has stopped on the desired program, turn the control selector switch to **SINGLE OPERATION**.

6. When the program start key is depressed, the machine will perform one program step at a time.

7. If the operator wishes to examine a track at any time, it is only necessary to depress the keyboard read key, and then call out the desired track by depressing the corresponding character key.

NOTE: Because the file interlock switch is not jackplugged during this procedure, each time the program attempts to write onto the disk storage, the machine will stop and the file check light will glow. Operation may be resumed by depressing check reset, setting the program selector switches to the next program step, depress program set, and then program start.

METHOD 2

1. The test lock should be off.
2. The file interlock switch on the process control panel should not be plugged. By leaving this switch unplugged, it is impossible to destroy a file record.
3. Place the program selector switches so that they correspond to the first program that is to be executed, and place the control selector on **CONTROL STOP**.
4. After the processing unit has stopped on the initial step of the first routine, place the program selector to the first step of the second routine. When the program start key is depressed, the machine will perform the first routine and stop before executing the second routine.
5. At this point the operator can investigate the tracks that have been affected to determine if everything is in order. This may be accomplished by depressing the keyboard read key and selecting the proper track.

NOTE: Because the file interlock switch is not jackplugged during this procedure, each time the program attempts to write onto the disk storage the machine will stop and the file light will glow. Operation may be resumed by depressing check reset, setting the program selector switches to the next program step, depress program set, and then program start.

380 CONSOLE TYPEWRITER

A modified IBM Electric Typewriter located on the console unit is used as an output device for the RAMAC system. It may be used for output of manual inquiries, or as a supplementary printer under the control of the stored program.

The standard typewriter is equipped with a 16-inch carriage. Vertical spacing is six lines to the inch. Either a solid or pin feed platen may be specified. Associated with the typewriter is a control panel that provides the flexibility necessary for format control.

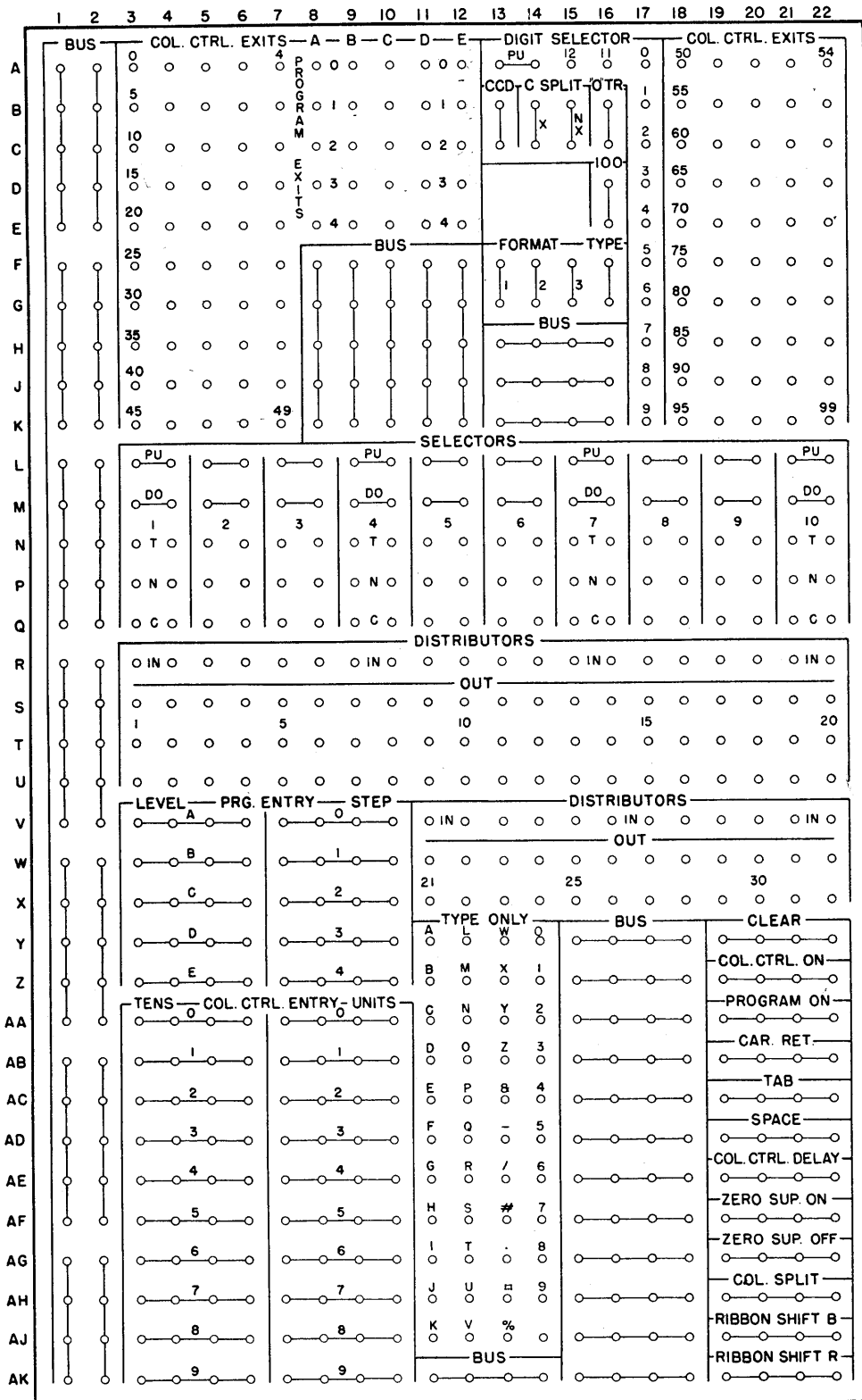
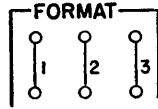

FIGURE 57. 380 TYPEWRITER CONTROL PANEL

TYPEWRITER CONTROL PANEL

THE FOLLOWING hubs are located on the typewriter control panel (Figure 57):



F-G, 13-15

Format. These hubs emit an impulse when the corresponding format (1, 2, or 3) key is depressed on the keyboard. The impulse from these hubs may be used to set selectors to establish format control for three different types of inquiries, and to establish the starting point of the typewriter control panel program. The impulse is not available until after the desired record has been transferred to the typewriter track.

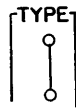

F-G, 16

Type. When the TYPE hubs are impulsed on the process control panel, the hubs labelled *Type* on the typewriter control panel emit an impulse that may be used to establish the starting point of the typewriter control panel program, and to pick up selectors to establish format control for lines typed out under stored program control.

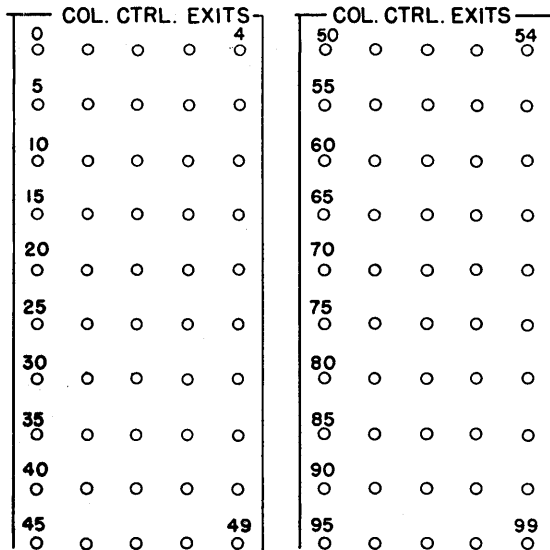

A-K, 3-7
A-K, 18-22

Column Control Exits. When the typewriter is being used for inquiries or for printing an auxiliary document, these hubs sequentially emit impulses that coincide with the reading of the corresponding position of the typewriter Q-track. These impulses control the format of the information being typed.

The first Q-track position to be read is controlled by wiring the COLUMN CONTROL ENTRY. Subsequently, the machine reads succeeding positions until the control is transferred elsewhere. This arrangement allows the typewriter to type fields from the typewriter track in any order.

If at any time the program unit or the COLUMN CONTROL DELAY is turned on, the COLUMN CONTROL EXITS stop emitting; but the same sequential position is held, unless the COLUMN CONTROL ENTRY is impulsed to transfer control to another position. When the PROGRAM ON hubs are impulsed, column control is automatically turned off until COLUMN CONTROL ON is impulsed. When COLUMN CONTROL DELAY is impulsed, an impulse is emitted from the CCD hub on the following cycle; then, column control is turned on again automatically.

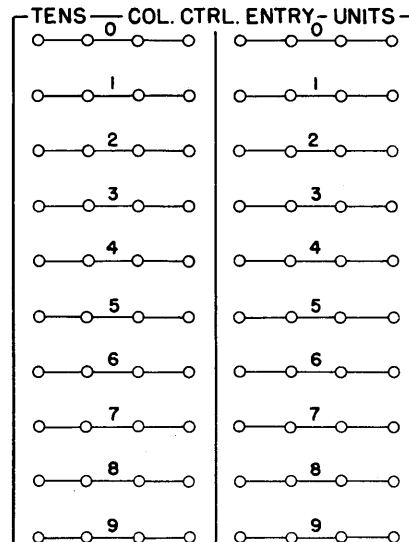

AA-AK, 3-10

Column Control Entry. To establish the beginning of a sequence of column control, one TENS and one UNITS hub are impulsed in the same manner that the PROGRAM ENTRIES are impulsed on the process control panel. Column control is turned on automatically by impulsing COLUMN CONTROL ENTRY, without impulsing COL CTRL ON.

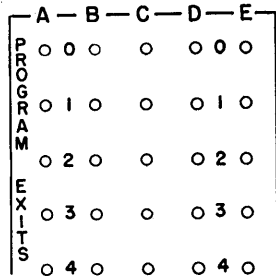

A-E, 8-12

Program Exits. When PROGRAM ON is impulsed, these hubs sequentially emit impulses when the typewriter is being used for inquiries or for printing an auxiliary document. These impulses are used for typewriter control and to type constants, legends, and special characters not on the typewriter track. Until the program is turned off by impulsing COL CTRL ON or COLUMN CONTROL ENTRY, the program advances through steps 0-4 in levels A-E. When the program is first turned on after the final dropout of the previous operation, PROGRAM EXIT A0 will emit, followed by A1, A2, A3, A4, B0, B1, B2, etc. The program impulses may be started at another point by impulsing program entries.

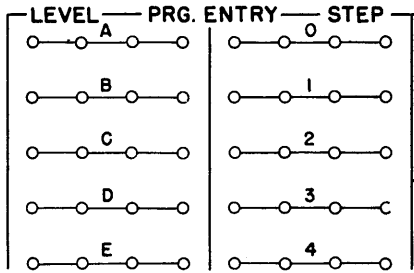

V-Z, 3-10

Program Entry. To establish the beginning of a sequence of program impulses, one LEVEL hub and one STEP hub are impulsed in the same manner that the PROGRAM ENTRIES are impulsed on the process control panel. The program unit is turned on automatically by impulsing PROGRAM ENTRY, without impulsing PROGRAM ON.

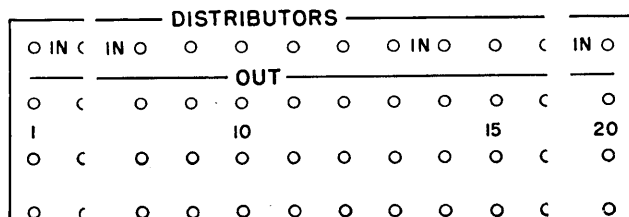

RU, 3-22

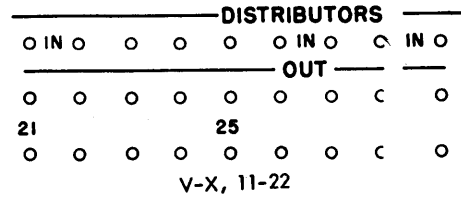

Distributors. Impulses that are used to initiate several functions are wired through distributors that serve the same function as split wires but prevent possible back circuits. An impulse wired into the IN hub of a distributor is available as the associated OUT hubs, but impulses cannot travel between OUT hubs, or from an OUT hub to the IN hub. Any impulse except that from the OUT hub of another distributor may be wired through a distributor.

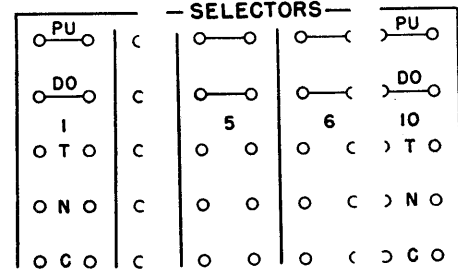

L-Q, 3-22

Selectors. Ten 2-position selectors are provided to facilitate format control. Normally, a connection exists between each c hub and the N hub above it. When an impulse is wired to the PU hub, this connection is broken and the c hub is connected to the T hub. This connection remains until DO (drop out) hub is impulsed.

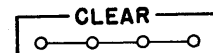

Y, 19-22

Clear. Impulsing these hubs causes the typing to stop and the carriage to return. All devices that have been picked up, such as selectors and zero suppression, will be dropped out. The column control and program units will be restored to zero and A0, respectively.

When CLEAR is impulsed from a COLUMN CONTROL EXIT while typing, the corresponding column will type; then the typewriter will clear.

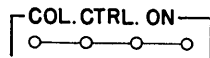

Z, 19-22

Column Control On. These hubs are impulsed to place the typewriter under column control. Program control is automatically turned off. Column control is turned on automatically if a COLUMN CONTROL ENTRY is made.

When impulsed from a PROGRAM EXIT, column control becomes active one cycle later, and will restart with the next column control position if column control has been previously used. If column control has not been previously used during the typewriter control panel program, column control will start at position zero.

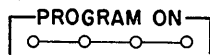

AA, 19-22

Program On. These hubs are impulsed to place the typewriter under program control. Column control is automatically turned off. Program control is turned on automatically when a PROGRAM ENTRY is made.

When impulsed from a COLUMN CONTROL EXIT while typing, the corresponding column will type; then, the machine will be placed under program control. If program control has been previously used, the next program in sequence will emit. If program control has not been previously used during the typewriter control panel program, program control will start with A0.

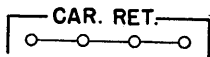

AB, 19-22

Carriage Return. Impulsing these hubs causes the typewriter carriage to return to the left margin.

When impulsed from a COLUMN CONTROL EXIT, the corresponding column will type; then the carriage will return.

Wiring (Figure 58)

Type a record that has been transferred to the Q-track. The format is a three-line address as indicated.

1. An impulse is available at the TYPE hub after the record has been transferred to the Q-track. This impulse is wired to turn column control on. COLUMN CONTROL will start in position zero. Therefore, typing

will begin at position zero of the Q-track and proceed to position 1, 2, 3, etc. This will continue until the sequence is altered by control panel wiring.

2. The character in position 20 of the Q-track will type; then, the carriage will return. Typing will then resume.

3. Position 35 of the Q-track will type; then, the carriage will return.

4. Position 50 of the Q-track will type; then, the machine will clear.

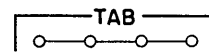

AC, 19-22

Tabulate. Impulsing these hubs causes the carriage to tabulate to the next tab stop. It may be impulsed by a typewriter PROGRAM EXIT or CCD to initiate immediate tabulation, or it may be impulsed from a COLUMN CONTROL EXIT to cause tabulation after the corresponding Q-track character has been typed.

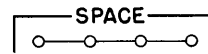

AD, 19-22

Space. Impulsing these hubs causes the typewriter to space one space. It can be impulsed by a typewriter PROGRAM EXIT, CCD, or the COLUMN SPLIT X- or NX-impulses.

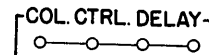

AE, 19-22

Column Control Delay. When these hubs are impulsed, column control is suspended for one cycle, during which an impulse is emitted from the CCD hub. Column control resumes immediately after this cycle, continuing from the step after the step that was wired to impulse the delay.

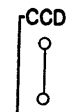

B-C, 13

CCD. Whenever COLUMN CONTROL DELAY is impulsed, the CCD hubs emit an impulse on the following cycle that may be used for spacing or other functions. Column control is suspended for the cycle on which these hubs emit. After one cycle, the column control resumes from the step after that on which the control was impulsed.

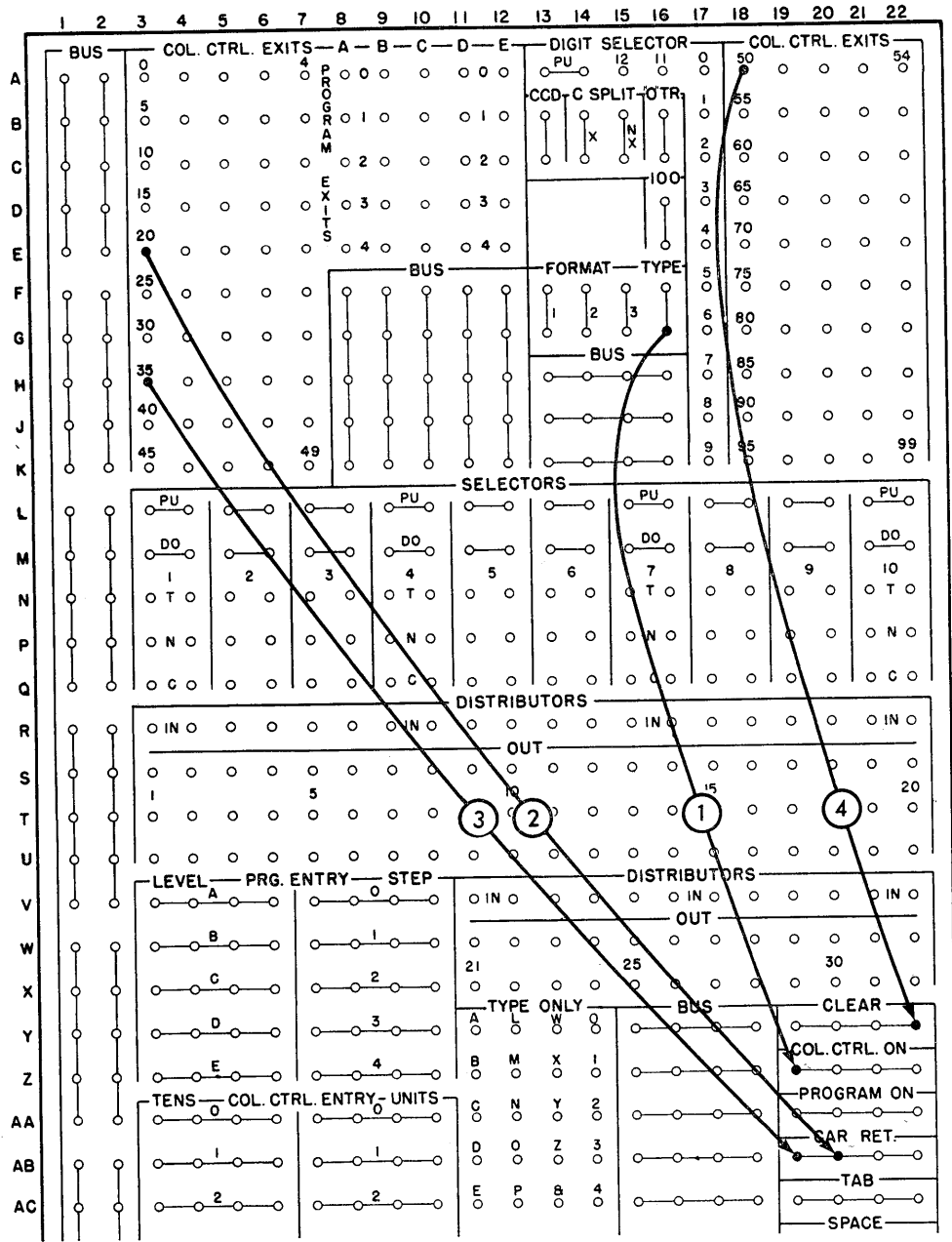

Record

Name	Street Address	City and State
0	20 21	35 36 50

Name _____
 Street Address _____
 City and State _____

FIGURE 58. PRINTING A THREE-LINE ADDRESS

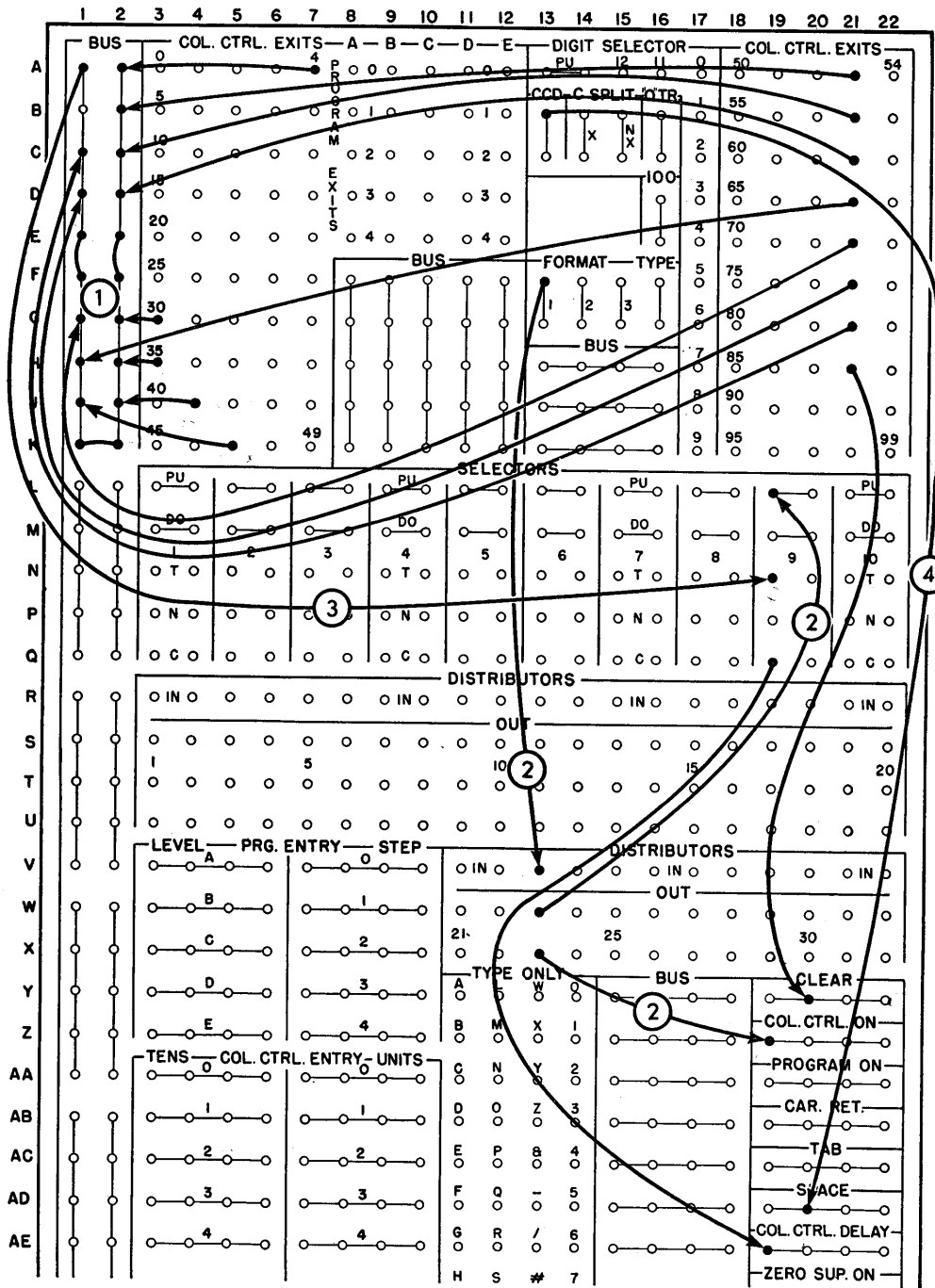

Wiring necessary to print the following disk record inserting one space between each column.

Disk Record

Item No.	Description	Price	Price	Price	Price	Old Bal.	Rec.	Req.	On Hand	On Order	Min. Inv.	Avail-able		
0 415		30	31	35	41	47	53	58	63	68	73	78	83	88

FIGURE 59. SPREADING A RECORD

Wiring (Figure 59)

Assume a manual inquiry of a disk record is to be made. The disk record is stored as one continuous record. The format is in the same sequence; however, one space is inserted between each column heading when the record is typed.

1. The units position of each field is wired to the bus.

2. When the format 1 key is depressed, an impulse will become available as soon as the machine will allow a manual inquiry. This impulse, wired through a distributor, initiates column control and picks up selector 9. In this example, it is not necessary to pick up the selector; however, this would be desirable if another format were to be wired on the same control panel. Conflicting instructions could then be selected.

3. The bus is wired through selector 9 to column control delay. As the Q-track is typed (when positions 4, 30, 35, 41, etc., are reached), COLUMN CONTROL DELAY is impulsed. Column control delay will suspend column control for one cycle, and the CCD hub will emit.

4. CCD is wired to SPACE.

5. Column control exit 88 is wired to CLEAR. This will drop out selector 9 and restore column control to zero.

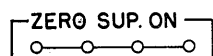

AF, 19-22

Zero Suppression On. When this hub is impulsed, a zero read from the typewriter track will not be typed. Instead, an impulse will be emitted from the OTR hubs, which may be wired to cause spacing or some other function. The printing of zeros is resumed when the ZERO SUP OFF hub is impulsed, or when a character other than zero is read from the track. This arrangement allows the zeros in the high-order positions of fields to be suppressed.

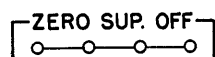

AG, 19-22

Zero Suppression Off. These hubs are impulsed to turn the zero suppression feature off when it is desired to print zeros to the left of significant digits, and the feature has been turned on by previous wiring.

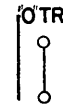

B-C, 16

OTR. Whenever the zero transfer feature is turned on by impulsing ZERO SUP ON, a zero read from a typewriter track is not printed. Instead, an impulse is emitted from these hubs and may be wired to SPACE to maintain vertical column alignment.

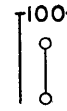

D-E, 16

100 (Type 100). Impulsing this hub causes all 100 characters to be typed from the typewriter track, in position sequence, without format control.

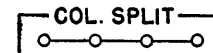

AH, 19-22

Column Split. Impulsing these hubs causes the column split device to analyze the character being typed for the presence or absence of an X-bit. On the next cycle, column control will be suspended, and an impulse will be available out of either the COLUMN SPLIT X- or NX-hubs located adjacent to the digit selector.

When column split is impulsed from a COLUMN CONTROL EXIT, the corresponding Q-track position will type only the numeric portion of the character; that is, the zone portion of any character A through R and some special characters would not print.

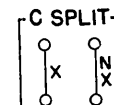

B-C, 14-15

Column Split (X-NX). When column split is impulsed, any character containing an X-bit (A-R and some special characters) will type as a numeric digit only. In addition, on the next cycle, column control is suspended and the X- or NX-hub will emit. If the character contained an X-bit, an impulse will be available out of the COLUMN SPLIT X-hub. If the character did not contain an X-bit, an impulse will be available out of the COLUMN SPLIT NX-hub.

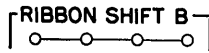

AJ, 19-22

Ribbon Shift Black. Impulsing this hub causes the typewriter to type through the black portion of a two-color ribbon.

When impulsed from a COLUMN CONTROL EXIT, the ribbon will shift for the typing of the next character.

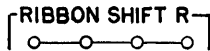

AK, 19-22

Ribbon Shift Red. Impulsing this hub causes the typewriter to type through the red portion of a two-color ribbon.

When impulsed from a COLUMN CONTROL EXIT, the ribbon will shift for the typing of the next character.

TYPE ONLY			
A	L	W	0
B	M	X	1
C	N	Y	2
D	O	Z	3
E	P	&	4
F	Q	-	5
G	R	/	6
H	S	#	7
I	T	.	8
J	U	=	9
K	V	%	0

Y-AJ, 11-14

Type Only Entry. When these hubs are impulsed from PROGRAM EXITS, the corresponding characters are typed.

These hubs should not be wired from COLUMN CONTROL EXITS.

Wiring (Figure 60)

Figure 60 illustrates one method of typing a minus sign following an amount field. The units position of the amount field (position 48) contains a negative X over the digit.

1. Column control exit 48 is wired to COLUMN SPLIT.

2. One cycle later the X-hub will emit if the field is negative. This can be wired to type a minus sign (-).

3. If the amount was not negative, the NX-hub will emit one cycle later. This is wired to SPACE.

Wiring (Figure 61)

Figure 61 shows one method of typing a record in a rearranged sequence. The record is stored with field 1 in track position 0-30, field 2 in 31-50, and field 3 in 51-90. The desired sequence of printing is field 2, then field 1, and then field 3.

1. Format 1 is wired through a distributor to COLUMN CONTROL ENTRY so that the typing of the Q-track begins with position 31. This will start typing field 2.

2. COLUMN CONTROL EXIT 50 is wired through a distributor to start typing field 1 after track position 50 has been typed.

3. COLUMN CONTROL EXIT 30 is wired through a distributor to start typing field 3 after track position 30 has been typed.

4. COLUMN CONTROL EXIT 90 is wired to CLEAR.

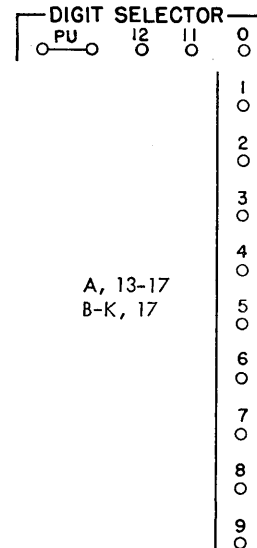

A, 13-17
B-K, 17

Digit Selector. It is sometimes desirable to know the contents of a certain typewriter track position so that format control may be altered on the basis of the character coding. When the PU hub is impulsed from a COLUMN CONTROL EXIT, the character in that position is analyzed and emitted in IBM code from the hubs labelled 12-9. While this is taking place, the printing of the character is suppressed.

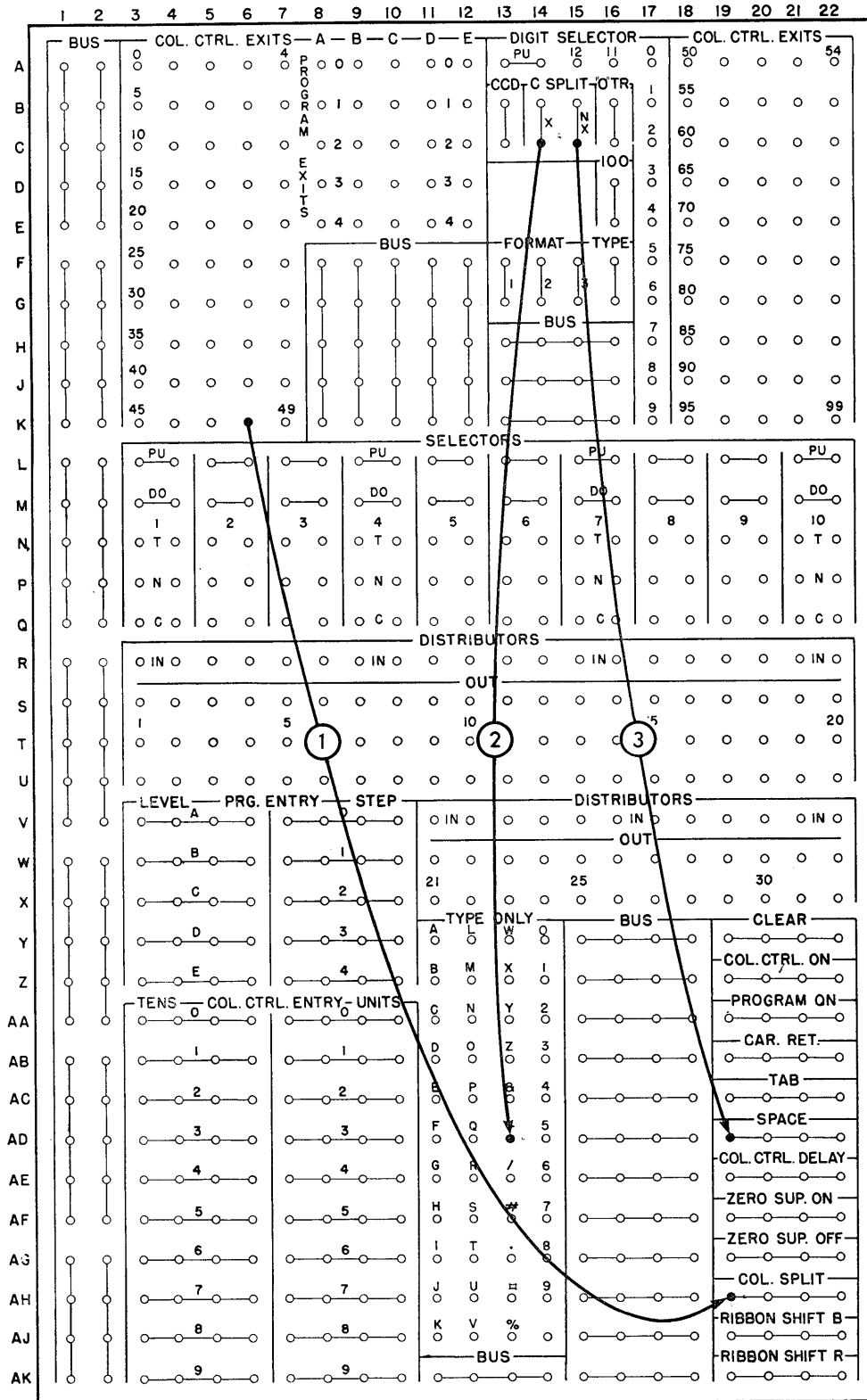
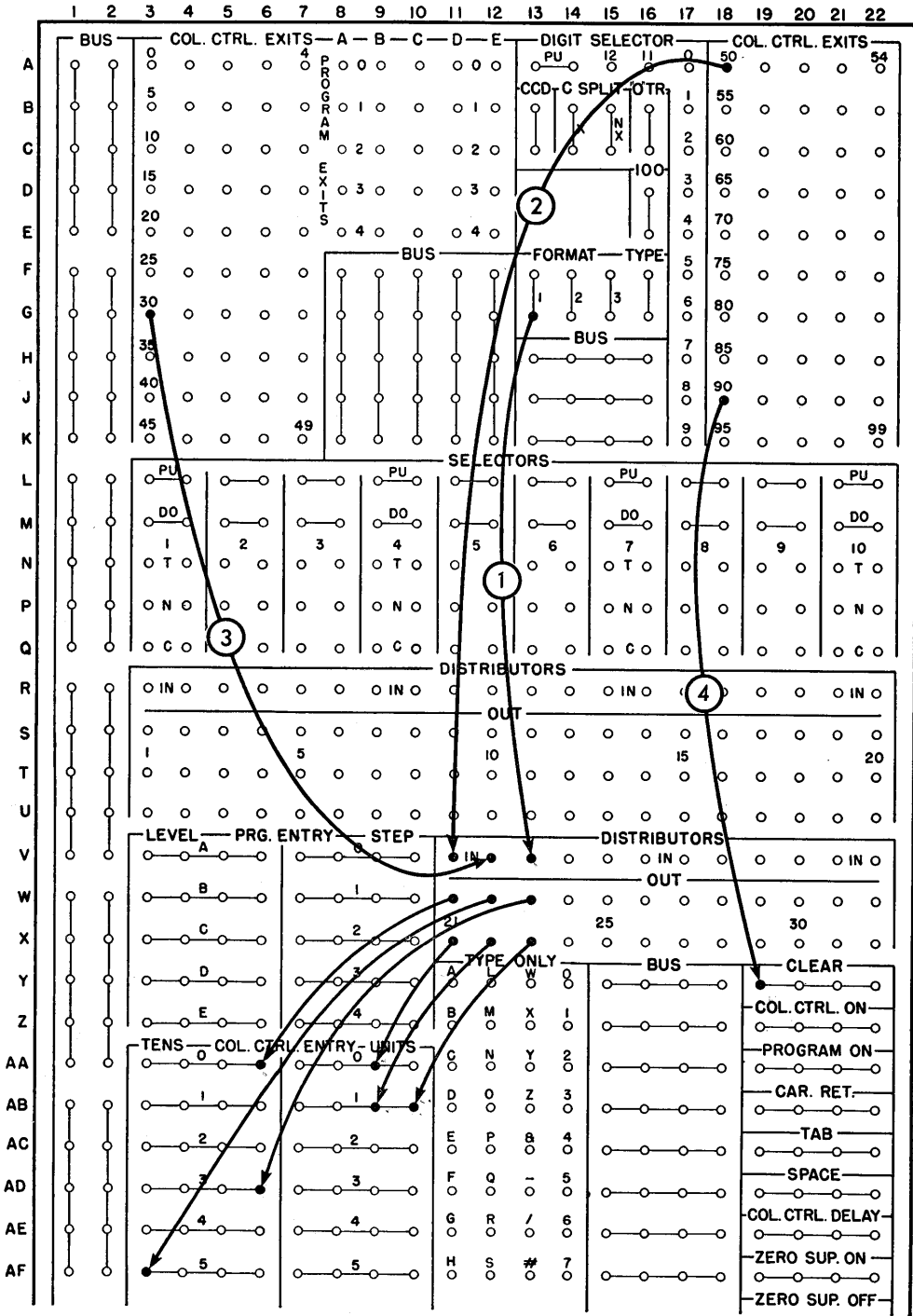

FIGURE 60. PRINTING A MINUS SIGN FOLLOWING AN AMOUNT FIELD



Disk Record

Field 1	Field 2	Field 3	
0	30131	50151	90191 99
Desired Printing Sequence			
Field 2	Field 1	Field 3	
1	20121	51152	91

FIGURE 61. RE-ARRANGING FIELDS

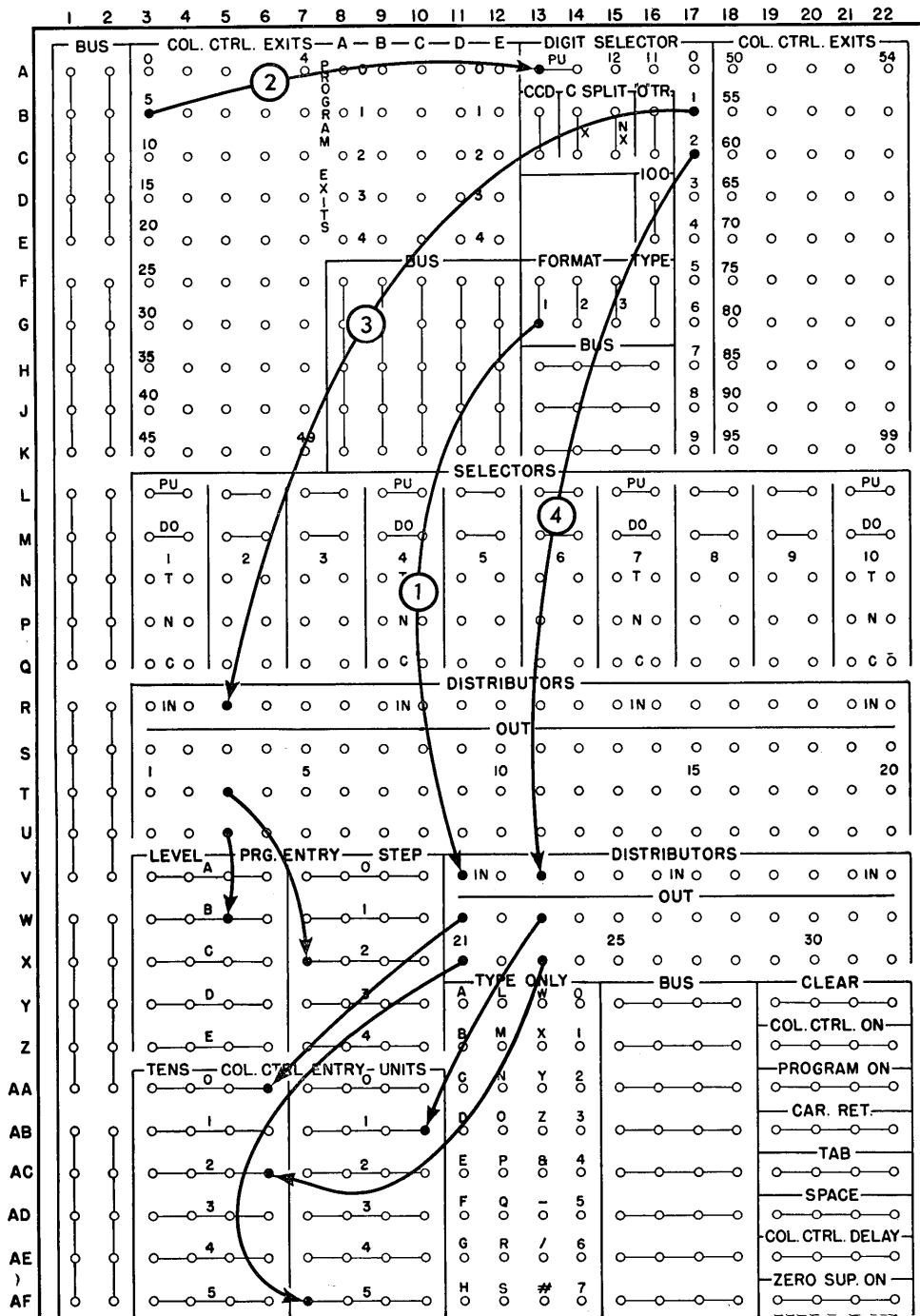

FIGURE 62. ALTERATION OF FORMAT CONTROL

Wiring (Figure 62)

In this example, either PROGRAM ENTRY or COLUMN CONTROL ENTRY will be initiated. The selection is based upon a code located in Q-track position 5.

1. Format 1 is wired through a distributor to start column control at position 5.

2. Track position 5 is wired to the digit selector PICKUP.

3. If track position 5 contained a digit 1, program control will be initiated one cycle later beginning at B2.

4. If track position 5 contained a digit 2, column control will be initiated starting with position 21.

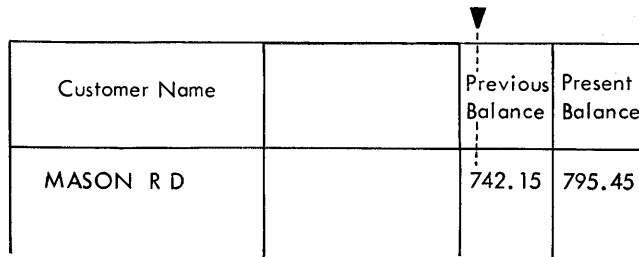
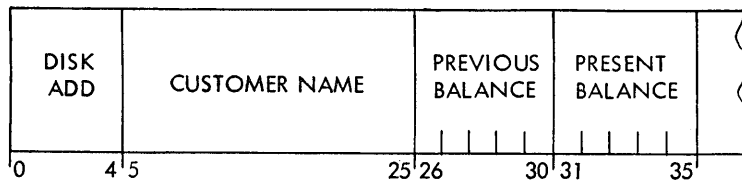

Desired Document Format.
 ▼ indicates tab setting.
 Two spaces are allowed between the two amount fields.

Col. Control Position	Program	Description
05		F3 impulse starts program. Start typing name. Type name.
25		Type last character of name. Program on.
	A0	Tab and column control on.
26		Type first digit of previous balance. Zero sup. on. "0" TR wired to space.
28		Column control delay. CCD type decimal.
29		Type tens position of previous balance.
30		Type units position, Zero sup. off, Program on.
	A1	Space between fields.
	A2	Space and column control on.
31		Type first digit of present balance, Zero sup. on. "0" TR wired to space.
33		Column control delay. CCD type decimal.
34		Type tens position of present balance.
35		Type units position, clear.

FIGURE 63. PART 1

Wiring (Figure 63)

Figure 63 shows the program for typing a disk

record. The desired document format calls for one tab setting, and two spaces between the two balance columns. Decimals are inserted by programming.

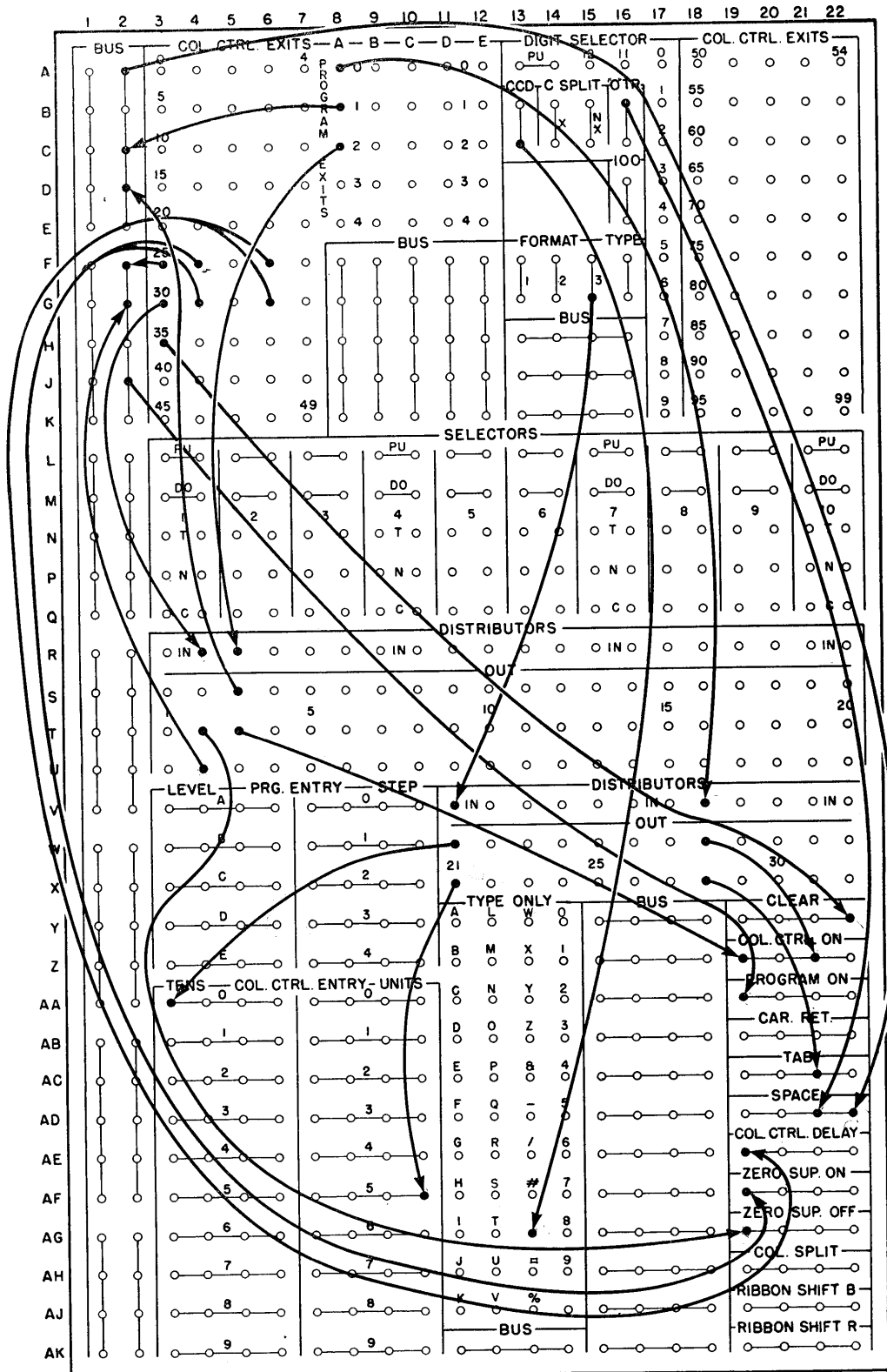

FIGURE 63. PART 2

370 PRINTER

THE 370 output printer (Figure 64) prepares a printed document while transactions are being posted in the machine. The printer is a serial printing device that prints from a single, octagonal printing stick. Information to be printed is available from the output track. Special format control is provided on the printer to allow any character stored on the output track to be printed in any printing position.

Stick Printing

A single, octagonal printing stick (Figure 65) is used to print the complete alphabet, the numbers 0-9, and eleven special characters. Horizontal spacing is 10 characters per inch, and a total of 80 characters per line may be printed. Vertical spacing is six lines per inch. To print an 80-character line and return the carriage requires approximately two seconds. Shorter lines are printed in less time.

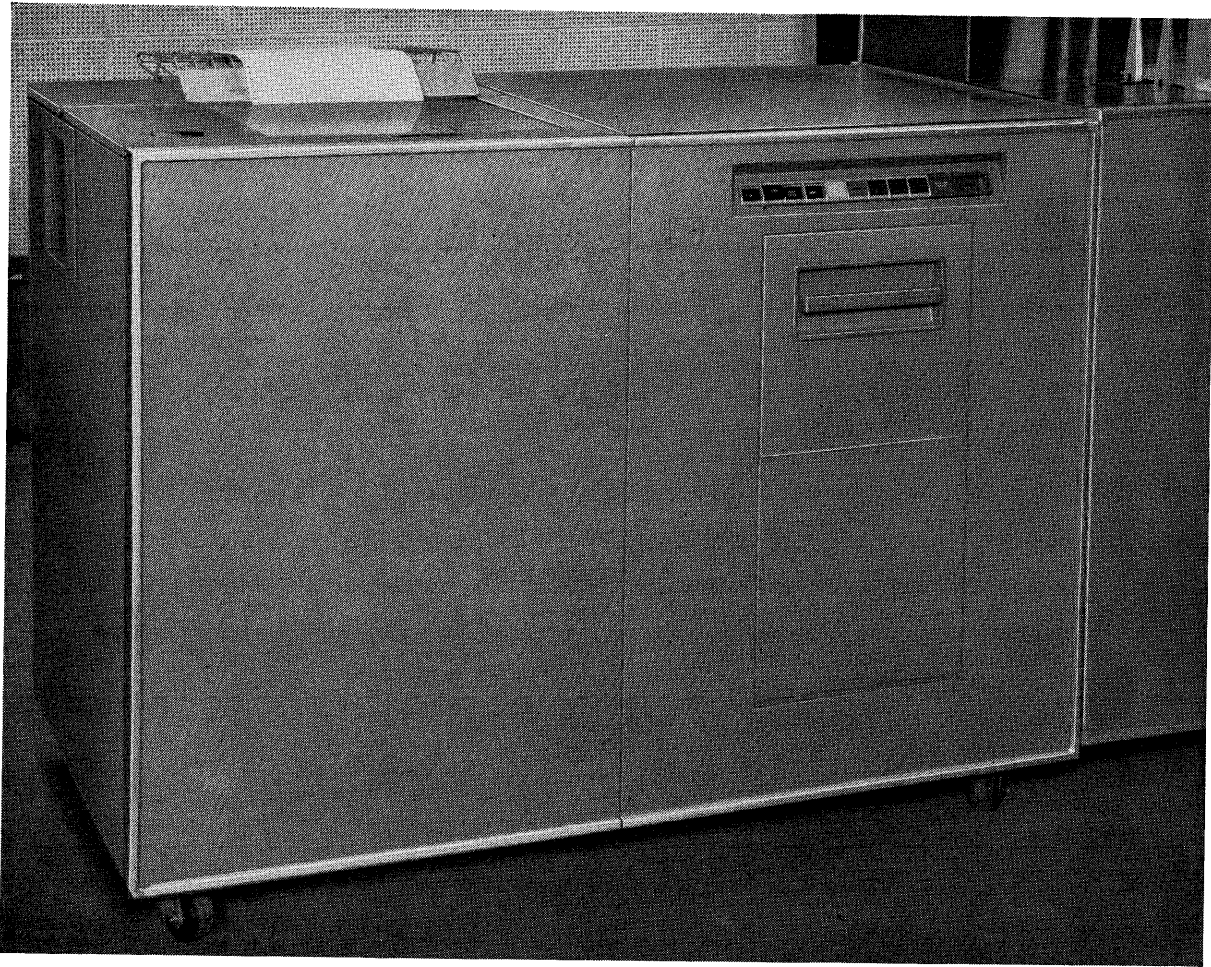

FIGURE 64. 370 PRINTER

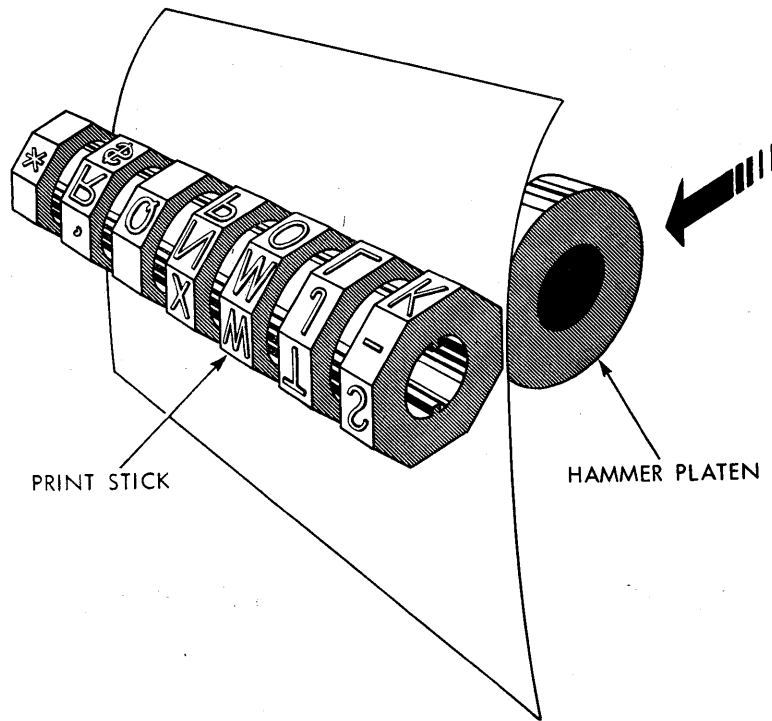

FIGURE 65. PRINT STICK AND PLATEN

The print stick is positioned by a combination of horizontal and rotary motion before printing each character. The stick contains seven characters along the length of each octagonal plane. Because the overall length of the print stick is approximately one inch, and the horizontal spacing between each printed character is one-tenth of an inch, the stick may, in some cases, rotate and move several positions to the left in order to align certain characters for printing. However, because the entire print mechanism spaces one-tenth of an inch to the right before printing each character, the over-all movement of printing is left to right across the page to print 80 characters.

To print each character, a hammer platen, which is located in back of the paper and which is one character in width, strikes the paper from the back, thus forcing the paper against the print stick to form the character impression.

Figure 66 illustrates the arrangement of the print stick. When the diagram is folded, the print stick is obtained.

@	9	8	5	4	1	HOME
✓	#	✓	7	6	3	2
%	Z	Y	V	U	/	ZERO
✓	,	:	X	W	T	S
*	R	Q	N	M	J	-
✓	\$.	P	O	L	K
□	I	H	E	D	A	&
✓	.	✓	G	F	C	B

↑
Direction of Rotation

FIGURE 66. PRINT STICK ARRANGEMENT

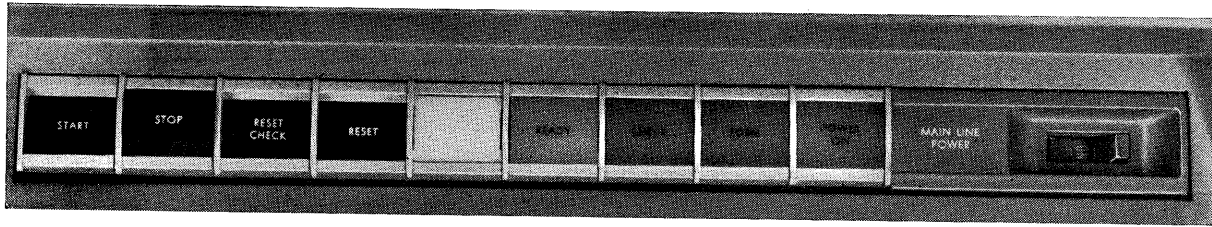

FIGURE 67. 370 PRINTER OPERATING KEYS AND LIGHTS

OPERATING KEYS AND LIGHTS (Figure 67)

THE following operating keys and lights are located on the 370 Printer.

Keys

Start

When the start key is depressed, the printer is placed in a ready condition. The ready light will come on, and the printer will be put under the control of the processing unit. This key is inactive if a check or form light is on.

Stop

Depressing this key during a print cycle will stop the printer after it has completed the cycle, and remove it from a ready condition. The process unit will stop as soon as the program refers to the output track.

Check Reset

Depressing this key restores the printer error detecting circuits, turns off the check light, and breaks the output track interlock. It is used after a printer parity or setup check error.

Reset

When this key is depressed, all printing and error detecting circuits are restored. All selectors are dropped out. Zero suppression, MLP, etc., are reset. Because it will reset all printer circuits, it should not be used after a simple parity or setup check error.

Main Line Power

This switch is used to turn the ac and dc power either on or off.

Lights

Ready Light

When this light is glowing, the printer is ready to accept information from the processing unit.

Check Light

This light will come on for either a parity or print setup error.

Form Light

This light will come on and the printer will stop when the last form is approximately 1 1/2 inches from the print stick. The operator must insert a new form to turn the light off.

Power On

This light will glow when the printer has been supplied with ac and dc power.

Print Cycle

The basic print cycle (Figure 68) may be divided into two sections, analysis and printing. Because it will usually be desirable to vary the document format (headings, body, totals, etc.), an analysis or decision period is provided before the actual printing begins.

During the analysis portion of the cycle, any character on the output track may be directed to the control panel and analyzed. Selectors may be transferred, or other devices on the control panel may be set up. In this way, all of the desired controls are established prior to the printing of the first character.

After the analysis period is completed, printing will begin. Printing will continue until line end is impulsed on the printer control panel, or all 80 characters have been printed.

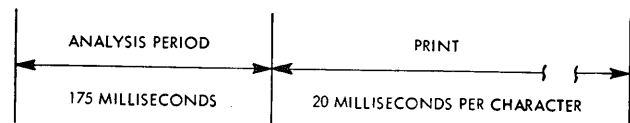

FIGURE 68. PRINT CYCLE

PRINTER CONTROL PANEL

(Figure 69)

THE printer control panel analyzes and directs the flow of information from the output track so that data may be printed in any desired format.

There are two types of hubs on the control panel, exits and entries. An exit hub emits an impulse, while an entry hub will accept an impulse that is wired to it. To perform any function or control the flow of any character of information, a connection must always be made from an exit to an entry.

Two types of exit impulses are available at the control panel, high level and low level. A high-level impulse may be wired to the output track, but it should not be wired to pick up a selector or to initiate a control function. The machine cannot be damaged by this type of wiring; however, improper operation would result. High-level impulses are available at the ANALYZER CONTROL IMPULSE hubs and the PRINT POSITION EXITS. All other exits emit low-level impulses.

To facilitate reference to specific hubs on the control panel, the rows are numbered 1 through 40, horizontally; and they are lettered A through BR, vertically.

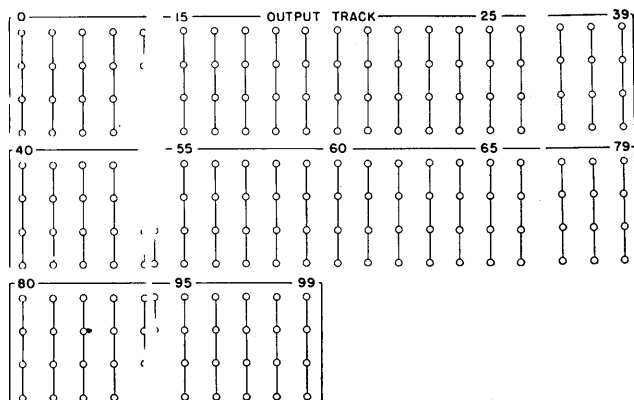

AU- BB, 1-40
BC-BF, 1-20

Output Track. Each of these 100 hubs correspond to a position of the output track. At each printing position the output track is read in its entirety; however, only one

character is selected for printing. If an OUTPUT TRACK position is wired from a PRINT POSITION EXIT, printing will result.



AB, 33-34

Interlock. These hubs must be jackplugged before any printing operation can be initiated. The printer will not operate if these hubs are left unplugged.

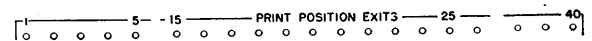

AT, 1-40
BR, 1-40

Print Position Exits. These hubs are wired to the output track to cause the corresponding positions to be set up for printing. An impulse is emitted from each PRINT POSITION EXIT hub as soon as the print head is located for printing at each of the 80 print positions. If PRINT POSITION EXIT 20 is wired to OUTPUT TRACK position 15, as soon as the print head arrives at print position 20, the character located at track position 15 will be printed.

Print position exits emit a high-level impulse that may be directed to the output track through selectors; however, they should not be wired to pick up selectors to a distributor, or to any function hub such as PRINT START, LINE END, X-ELIMINATE, etc.

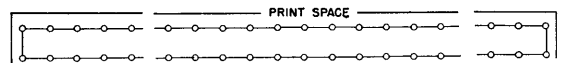

AJ-AK, 1-40
BG-BH, 1-40

Print Space. When a line is printed on a form, a single character is selected for printing at each print position. The machine automatically performs a print setup check on the character that is to be printed. If the print head arrives at a position where the corresponding PRINT POSITION EXIT hub has not been wired, a print setup error will occur. Therefore, all PRINT POSITION EXITS that are not wired to an output track position should be wired to PRINT SPACE. This wiring indicates to the machine that the corresponding print position should be spaced over without printing.

It is not necessary to wire PRINT SPACE if the printer is in a print-off condition. The printer will be in a print off condition if PRINT STOP has been impulsed. *Print Stop* is described in a later section.

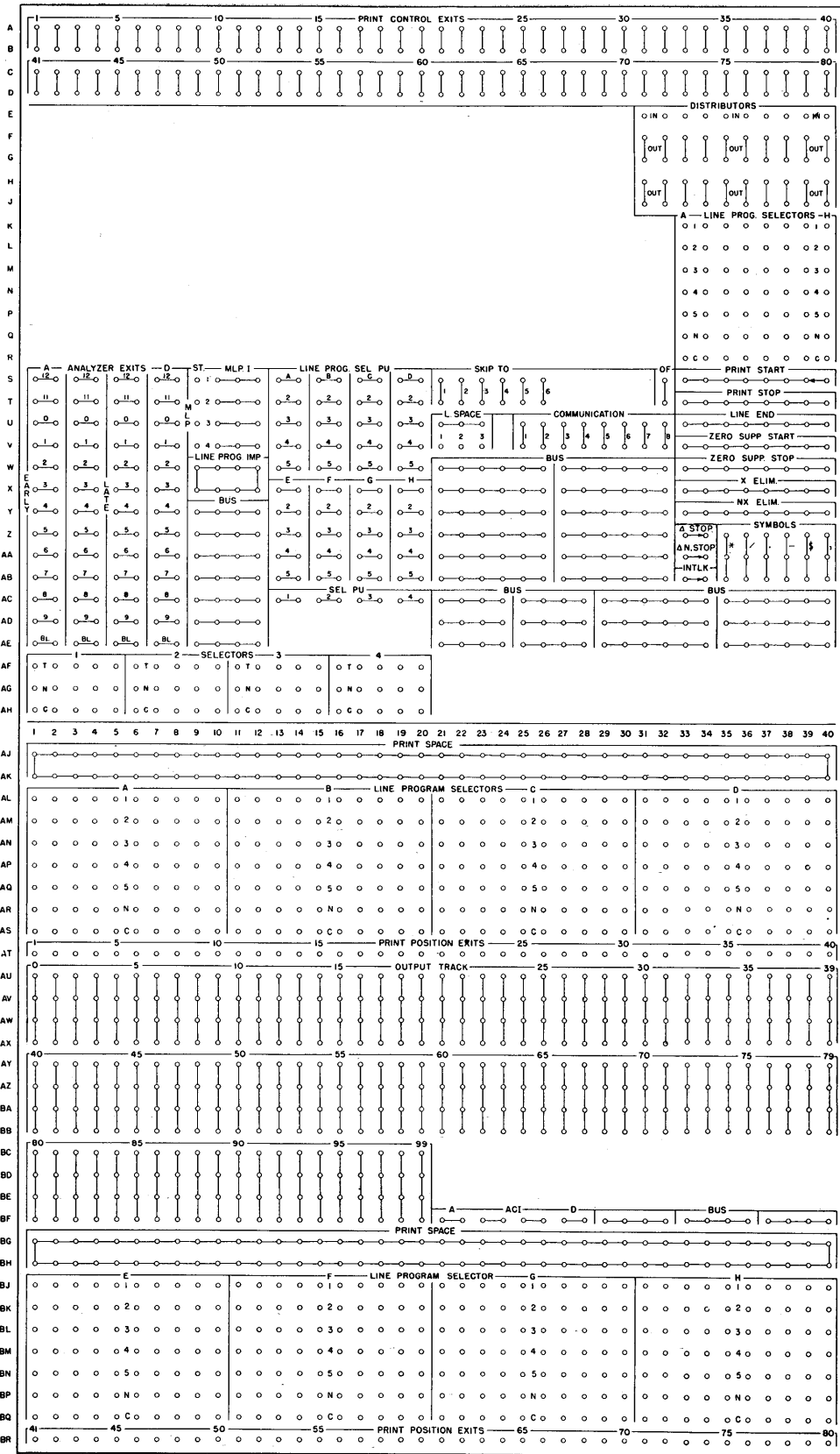

FIGURE 69. 370 PRINTER CONTROL PANEL

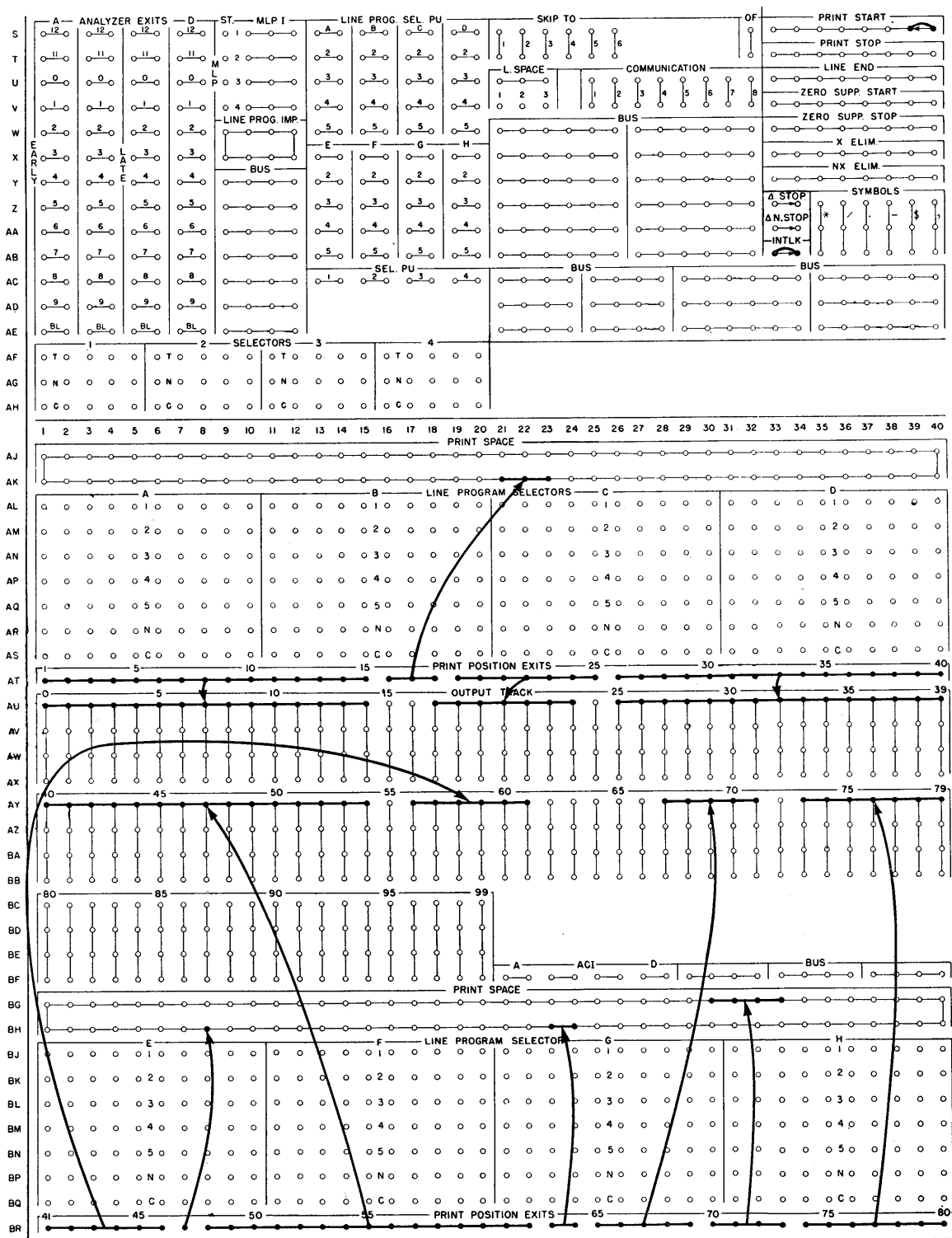

FIGURE 70. OUTPUT PRINTING AND PRINT SPACE

Wiring

Figure 70 illustrates the principle used to transfer data from the output track to print 80 characters. All PRINT POSITION EXITS not wired to an output track

position must be wired to PRINT-SPACE if the printer is in a print-on condition. The printer will be in a print-on condition if PRINT START has been previously impulsed. PRINT START is described in a later section.

Analyzers. When a record has been transferred to the output track, and PRINT (on the process control panel) has been impulsed by a program exit, the printer prepares to print a line. However, before the print mechanism moves from the home position, predetermined positions of the output track may be analyzed for the presence of certain character codes which will signify specific selector and format controls.

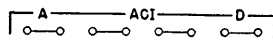

BF, 21-28

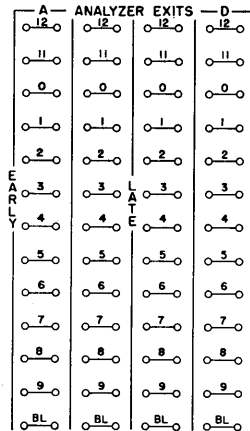

S-AE, 1-8

An ANALYZER CONTROL IMPULSE hub (ACI) is wired to the output track position that contains the control code. The ACI hub will emit an impulse (high level) which will cause the analysis of the corresponding OUTPUT TRACK position. If the output track contained a digit six, the six exit of the associated analyzer will emit; if the output track contained a digit two, the two exit will emit, etc. Alphabetic characters are set up in standard IBM code; that is, if an A is analyzed, the 12 and 1 exits will emit. These impulses are normally wired to pick up selectors or to initiate an MLP (multiple line printing) operation.

The analyzer exit labelled *BL* (blank) will emit during the analysis portion of every print cycle unless a digit or character appears on the output track in the position being analyzed.

The ANALYZER CONTROL IMPULSE (ACI) hubs A, B, C, and D emit sequentially and cause the corresponding analyzers to set up in the same sequence. ANALYZER EXITS A and B are classified as early exits, and emit at the same time—just after setting up analyzer B. ANALYZER EXITS C and D are late exits, and emit at the same time—just after setting up analyzer D.

The early exits must be used to pick up selectors associated with the selection of triple spacing and may also be used to control selectors through which late exit impulses may be wired.

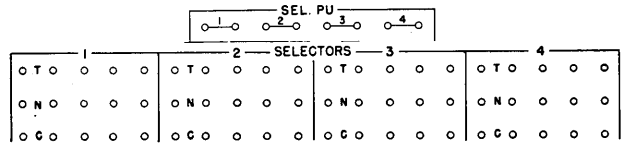

AC, 13-20
AF-AH, 1-20

Selectors. These selectors may be used independently, or to supplement the line program selectors. Each selector has five positions, and each position has a COMMON, a NORMAL, and a TRANSFERRED hub. Normally a connection exists between the COMMON and the NORMAL hub; however, when the selector pickup is impulsed, this connection is broken and a connection is made between the COMMON and the TRANSFERRED hub. The selector should be picked up during the analysis portion of the print cycle. It will remain transferred for the entire line.

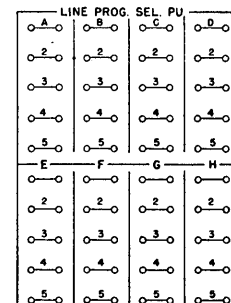

S-AB, 13-20

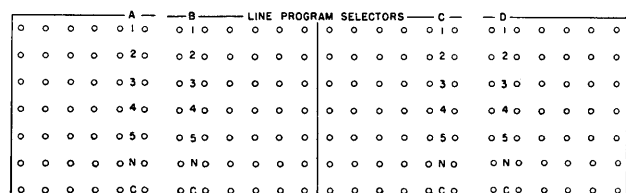

AL-AS, 1-40
BJ-BQ, 1-40
K-R, 33-40

Line Program Selectors. The line program selectors are provided to allow format control of the information being printed from the output track. Each selector has eleven positions; ten of these are grouped near the output track, and an eleventh position of each selector is near the control section. Each position has a COMMON hub, a NORMAL hub, and five TRANSFERRED hubs. The COMMON hub is connected to the NORMAL hub until one of the five pickup hubs is impulsed (during the analysis portion of the print cycle). The COMMON hub is then connected to the corresponding TRANSFERRED hub above it. The line program selectors remain transferred until the line is printed and drop out as the print head returns to the home position.

Figure 71 illustrates line program selection.

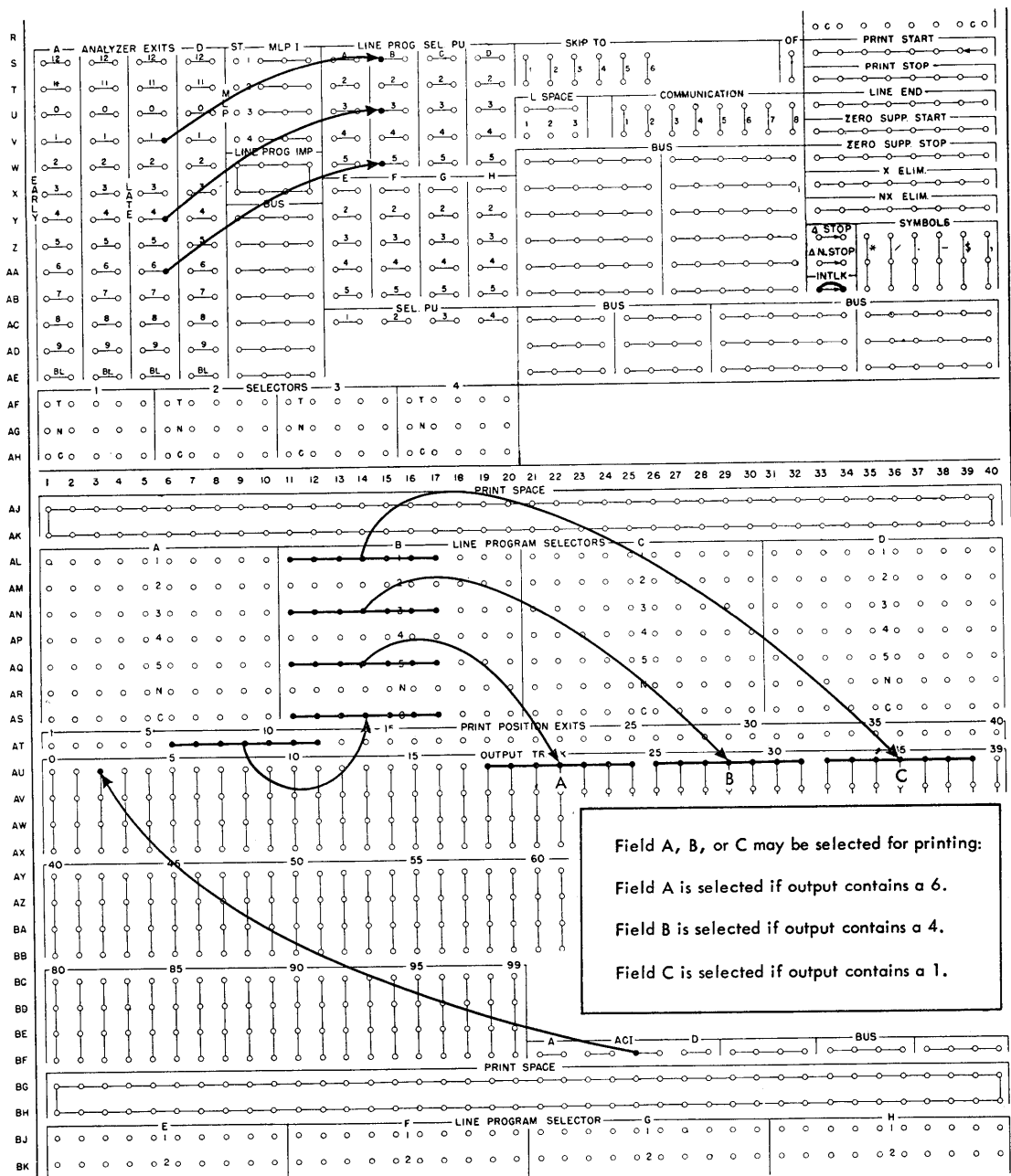
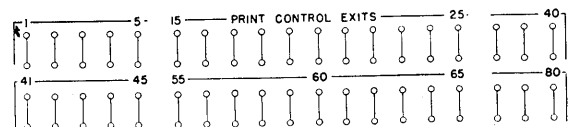

FIGURE 71. LINE PROGRAM SELECTION

Print Control Exits. These hubs emit control impulses as the printer is positioned to print the corresponding positions of the print line. The emitted impulse may be thought of as an early impulse; therefore, functions can be controlled before the actual printing of each character.

Each hub emits one impulse per line printed; for example, hub number five emits an early impulse each time print position five is being set up. These impulses are wired to initiate functions, such as print start and stop, zero suppression, X-elimination, etc. They may also be

wired to print symbols, provided the corresponding print position exit is not connected to the output track or to print space.



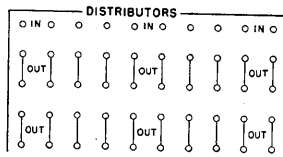

E-J, 31-40

Distributors. Impulses that are used to initiate several functions are wired through distributors, which serve the same function as split wires but prevent possible back circuits. An impulse wired into the IN hub of a distributor is available at the associated OUT hub; however, an impulse cannot travel between OUT hubs, or from an OUT hub to an IN hub. Distributors should not be wired so that an impulse from the OUT hub of one distributor is available at the IN hub of another distributor. High-level impulses should not be wired to a distributor.

Print Control Functional Hubs

The following hubs are wired from PRINT CONTROL EXITS to perform such print control functions as starting and stopping printing, controlling zero suppression, and X-elimination:

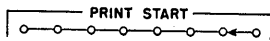

S, 33-40

Print Start. These entry hubs are impulsed from PRINT CONTROL EXITS to start printing at any desired column as the print head moves across the paper. Once printing is started, the machine will continue to print until printing is turned off by impulsing PRINT STOP. In this way, printing can be turned on and off several times in the course of printing a line to give added flexibility in format control. The PRINT CONTROL EXIT for the first column of each field to be printed is wired to these hubs. If the hub at the extreme right-hand position of PRINT START is plugged to an adjacent PRINT START hub, all printing will begin in print position one.

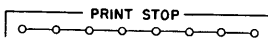

T, 33-40

Print Stop. These entry hubs are impulsed from the PRINT CONTROL EXIT of the first position not to be printed. When information is to be omitted, impulsing these hubs causes printing and print setup checking to be suppressed until PRINT START is impulsed.

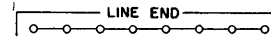

U, 33-40

Line End. These entry hubs are wired from the PRINT CONTROL EXIT of the position after the last position to be printed on a line to cause the printing to stop and the print head to return to the home position. This allows the length of the printing line to be controlled. Variable printing lengths are possible by wiring LINE END through selectors. LINE END need not be wired when printing 80 characters.

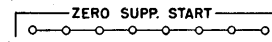

V, 33-40

Zero Suppression Start. These entry hubs are wired from the PRINT CONTROL EXIT of the high-order position of a field to eliminate the printing of zeros to the left of significant digits. When these hubs have been impulsed, the print unit spaces over positions containing zeros until a significant digit (any character other than zero, comma, or diagonal) is encountered. The significant digit is then printed and all zeros to the right of the significant digit are printed.

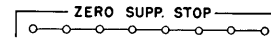

W, 33-40

Zero Suppression Stop. Once ZERO SUPPRESSION START has been impulsed, zero suppression will continue until a significant digit (not zero) is encountered and printed or until it is ended by impulsing these entry hubs from the PRINT CONTROL EXIT of the first position not to be suppressed.

Figure 72 illustrates print controls.

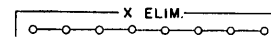

X, 33-40

X-Eliminate. Negative numbers are recorded on the output track (as on all other processing tracks) by an X-bit over the low-order position. For example, the amount 125 stands on the output track as 12N. The X-ELIMINATE and NX-ELIMINATE hubs allow the printer to read the X-punch or the digit punch from an output track position to separate the signed character into its sign and digit components. The X-ELIMINATE hubs are impulsed from PRINT CONTROL EXITS to cause only the digit portion of the character being set up to be printed.

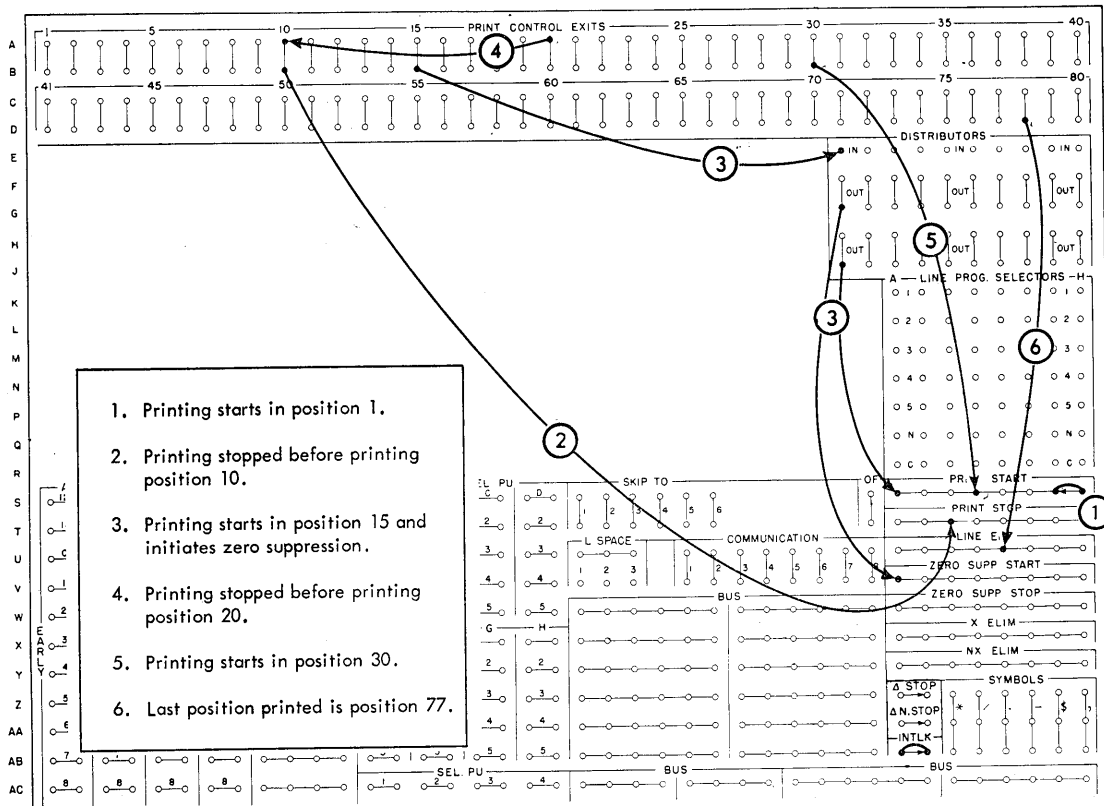
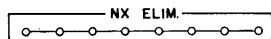
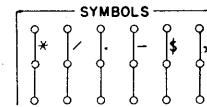

FIGURE 72. PRINT CONTROLS



Y, 33-40



Z-AB, 35-40

NX-Eliminate. A negative number on the output track contains an X-bit over its low-order position. For example, the amount 125 stands on the output track as 12N. By impulsing these hubs from a PRINT CONTROL EXIT, only the sign portion of the low-order digit will print.

Figure 73 illustrates printing a minus sign after an amount field.

Symbols. These entry hubs are wired from PRINT CONTROL EXITS to cause the corresponding symbol to be printed. These symbols may be selected through the line program selector. NOTE: The comma and diagonal is inoperative if zero suppression is on.

Other Control Panel Hubs

Δ (Delta). When the two hubs labeled Δ Stop are jack-plugged (if a print setup error occurs), the machine will print a Δ in the left-hand margin opposite the line in error, and the machine will stop.



Z, 33-34
AA, 33-34

When the two hubs labeled Δ N. Stop are jackplugged, the machine will print a Δ, but will not stop when a print setup error occurs.

If neither Δ STOP or Δ N. STOP are plugged, the machine will stop, but a Δ will not be printed if a print setup error occurs.

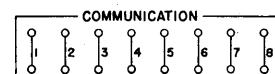

U-V, 25-32

Communication. These hubs connect to the correspondingly numbered hubs on the 305 process control panel to allow a signal communication between the processing unit and the printer.

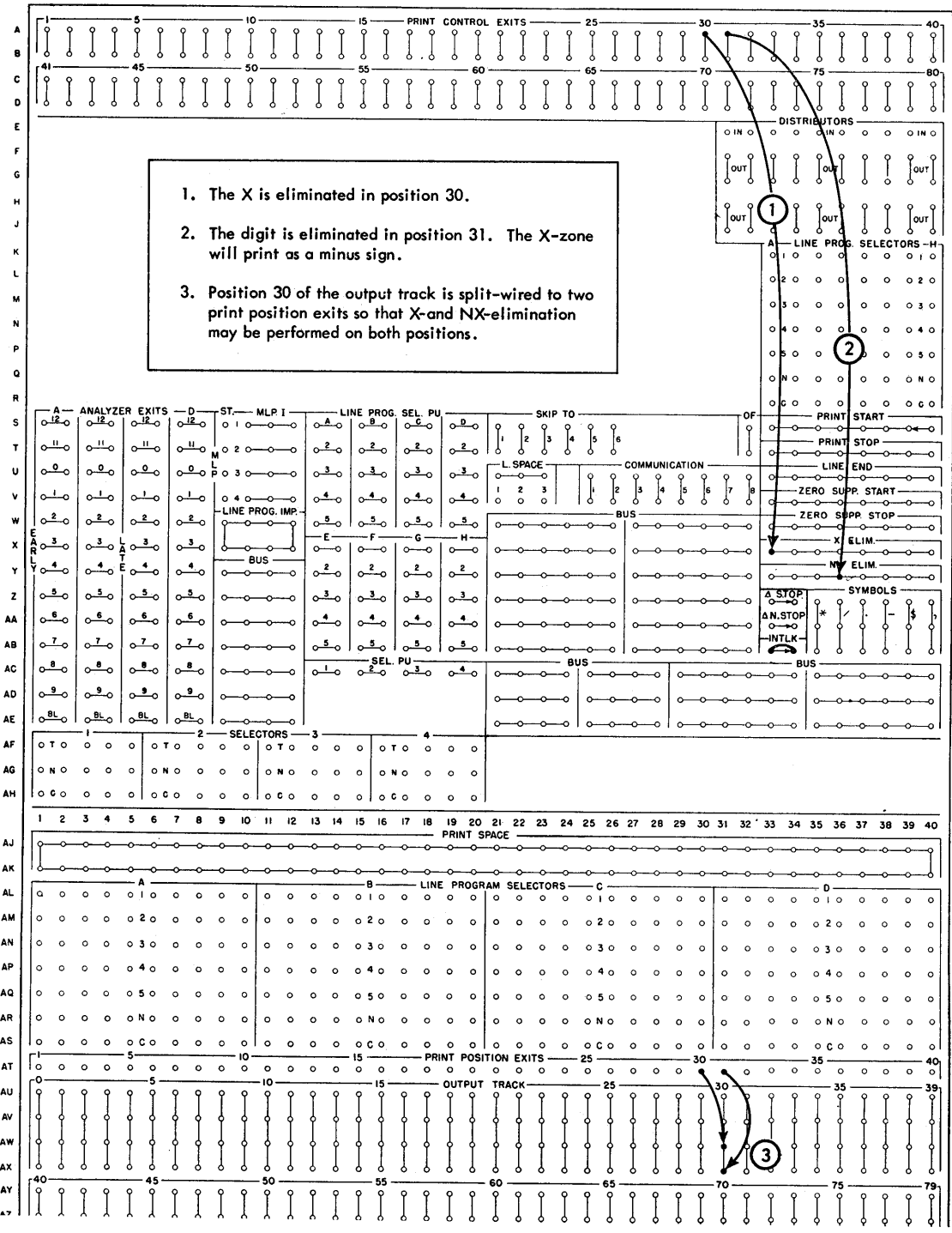

1. The X is eliminated in position 30.

2. The digit is eliminated in position 31. The X-zone will print as a minus sign.

3. Position 30 of the output track is split-wired to two print position exits so that X-and NX-elimination may be performed on both positions.

FIGURE 73. MINUS SIGN FOLLOWING AN AMOUNT FIELD

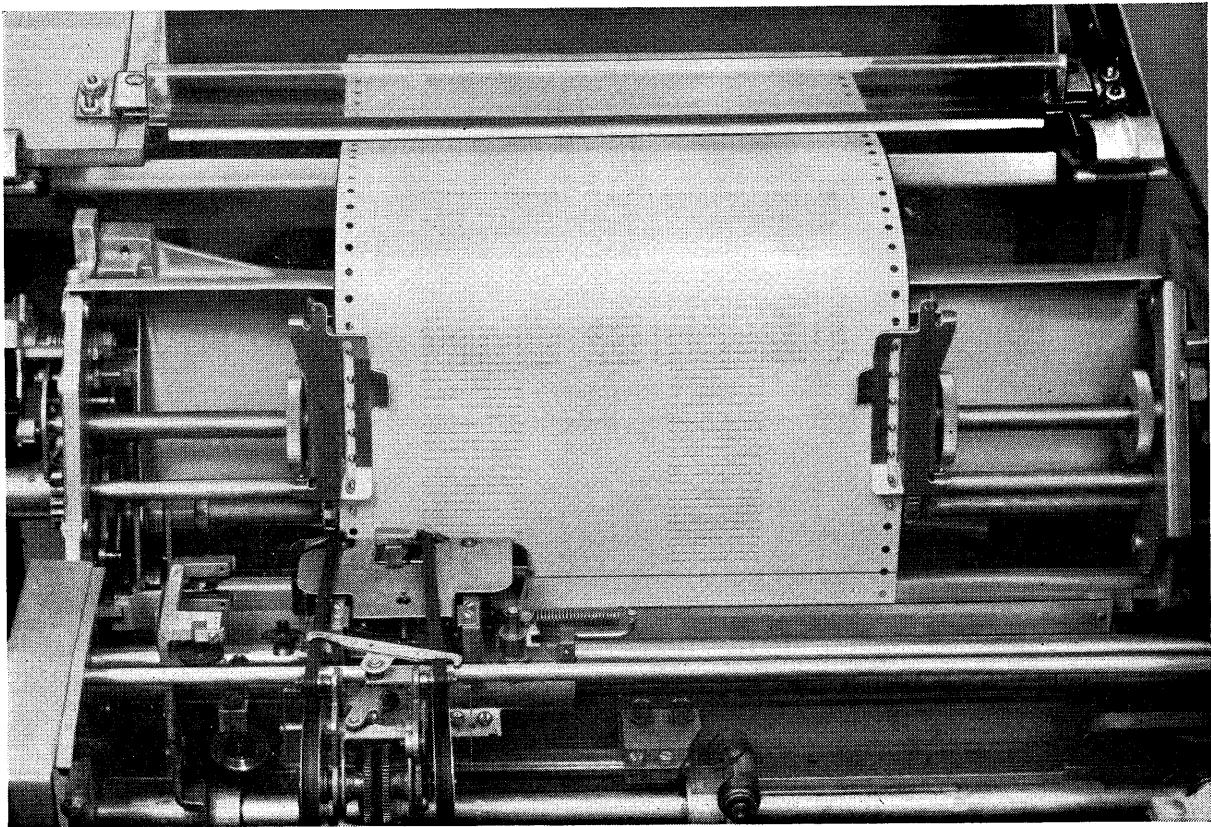

FIGURE 74. TAPE-CONTROLLED CARRIAGE

TAPE-CONTROLLED CARRIAGE

THE tape-controlled carriage (Figure 74) controls feeding, spacing, and skipping while documents are being printed. The carriage is controlled by punched holes in a paper tape that exactly corresponds to the length of one or more forms. Wiring on the printer control panel allows the selection of single, double, or triple spacing between printing lines, as well as skipping between forms or within the same form. Line spacing and skipping occur at the rate of 25 lines per second, or 4.17 inches per second.

Control Tape

The control tape (Figure 75) has 12 columnar positions indicated by vertical lines. These positions are called channels. A maximum of 17 inches can be used for control of a form on the 370 Printer, although, for convenience, the tape blanks are longer. Horizontal lines are spaced six to the inch for the entire length of the tape.

Round holes in the center of the tape are pre-punched for a pin-feed drive in a tape-sensing mechanism that controls the carriage. The tape is held in

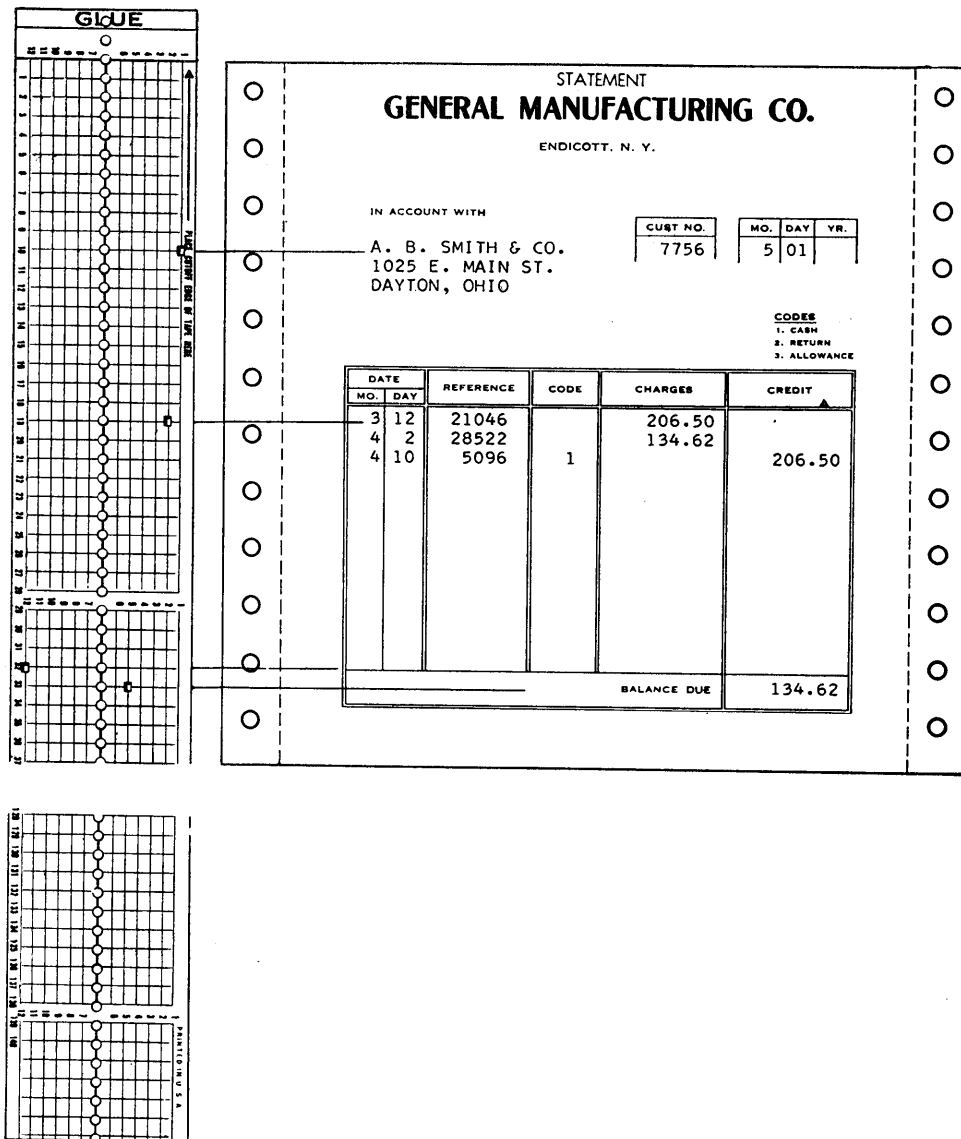

FIGURE 75. CONTROL TAPE

position at one end by the pin-feed device, and at the other end by the weight of a metal spool placed upon the tape.

Seven star wheels, one for each channel, are positioned over the tape for sensing the holes that are punched in the various channels. As viewed from the front of the machine, the number 12 channel is at the far left. Wheel one rests on channel one, wheel two on channel two, etc. A hole in the channel allows the star wheel to drop and cause the setup of the necessary circuits that are used to stop skipping.

Tape Inserting

To insert the tape, open the cover located adjacent to the platen knob. Release the star-wheel assembly by moving the release lever forward (located directly above the star-wheel holder). Insert the tape and lower the assembly. Place the metal spool over the opposite end of the tape. The tape may now be restored to place it at channel one (the home position) by depressing the restore key.



FIGURE 76. TAPE PUNCH

Tape Punching

A small, compact punch (Figure 76) is provided for punching the tape. The tape is first marked in the channels in which the holes are to be punched. This can be done easily by laying the tape beside the left edge of the form which it is to control with the top line (immediately under the glue portion) even with the top edge of the form. A mark is then made in the first channel on the line which corresponds to the first printing line of the form. Additional marks are made in the appropriate channels for each of the other skip stops and the overflow signal required for the form.

The marking for one form should be repeated as many times as the useable length of the tape will allow. With the tape thus serving to control several forms in one revolution through the sensing mechanism, the life of the tape is increased. Finally, the line corresponding to the bottom edge of the last form should be marked for cutting after the tape is punched.

The tape is inserted in the punch by placing the line to be punched over a guide line on the base of the punch and placing the center feed holes of the tape over the pins projecting from the base. The dial is then turned until the arrow points at the number

of the channel to be punched. Pressing on the top of the punch, toward the back, cuts a rectangular hole at the intersection of a vertical and horizontal line in the required channel of the tape.

After the tape is punched, it is cut and looped into a belt. The bottom line is glued to the top line by the section marked *Glue*, after the glaze has been removed by an ink eraser. If the glaze is not removed, the tape ends may come apart. The center feed holes should coincide when the two ends of the tape are glued together.

The last hole punched in the tape should not be less than four lines from the cut edge, because the last half inch (approximately) of the tape overlaps the glue section when the two ends are spliced. If it is necessary to punch a hole lower than four lines from the bottom of the form, the tape should be placed with the top line (immediately under the glue portion) four lines lower than the top edge of the form before marking the channels. To compensate for the loss, the tape should then be cut four lines lower than the bottom edge of the form.

Form Sizes

A double forms tractor is adjustable horizontally to accommodate forms of up to 16 inches in width including feeding strips. The maximum length of a form that may be used is approximately 17 inches.

The length of the printing line has a limit of eight inches. When a form 16 inches wide is used, the eight-inch printing area is centered in the form area, providing a maximum margin of four inches on either side. Forms of smaller width may be shifted (limited by the width of the form) to effect a shift of the eight-inch printing area on the form. For example, a twelve-inch form may be positioned so that the eight-inch printing area will start at the left-hand side leaving a four-inch margin on the right, or the form could be positioned to leave a four-inch margin on the left. Larger margins can, however, be obtained if the printing starts to the right of position one, or stops before position 80.

Forms with marginal punched holes on both sides must be used. Printing nearer the perforation than one-half inch on horizontal or vertical dimensions may cause the perforation to become detached when single part forms are used.

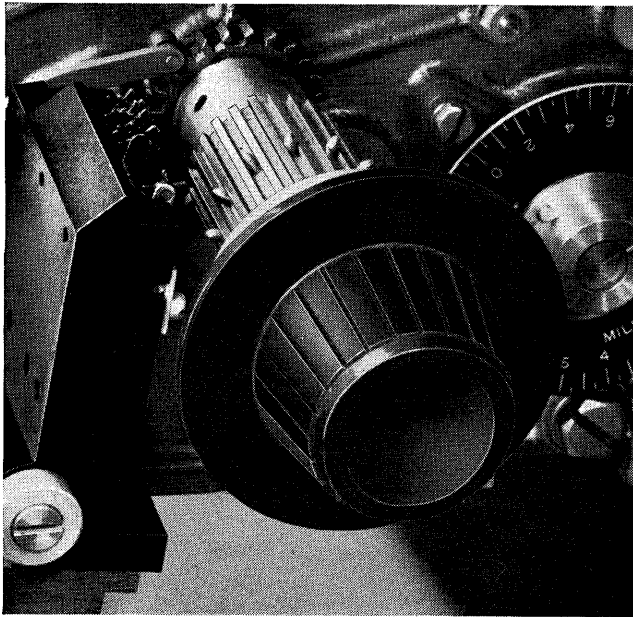

FIGURE 77. FORMS TRACTOR POSITIONING KNOB

OPERATING FEATURES

Forms Tractor Clutch (Figure 77)

The forms tractor may be disengaged to synchronize the control tape with the form by pushing in the forms tractor positioning knob. To move the form up one space at a time, turn the forms tractor positioning knob with the clutch engaged. To move the form less than one space, disengage the forms tractor clutch and rotate the forms tractor positioning knob.

Restore (Figure 78)

Depressing this key will cause the form to feed if the forms tractor clutch is engaged. To set the carriage at the home position (channel one) before starting a print operation, press in on the forms tractor positioning knob to disengage the forms tractor clutch, and depress the restore key.

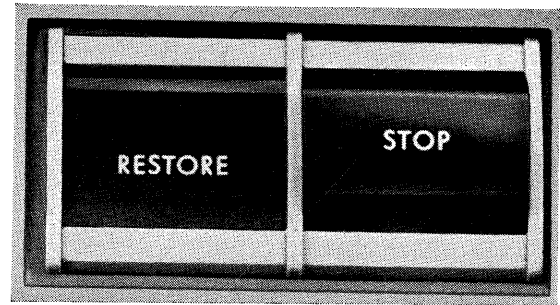

FIGURE 78. CARRIAGE CONTROL KEYS

Stop Key (Figure 78)

When this key is depressed, carriage and printer operations are stopped immediately. Normally, it stops the flow of paper after the restore key has been depressed. It also stops runaway skipping which can result from improper insertion of tape, wrong tape, impulsing a SKIP-TO for which no channel is punched, etc.

Inserting a New Form

To insert a new form, lift the top cover and open the left-hand front door. Paper may be inserted by sliding it up between the form feed guide plates. To lock the paper in position, move the pressure plates away from the tractor pins, position the form, and lower the pressure plates. After positioning the form for the first printing line, the forms tractor may be restored to the home position (channel one) by disengaging the forms tractor clutch and depressing the restore key.

Form Thickness Adjustment Device (Figure 79)

To compensate for various thicknesses of paper stock or for varying numbers of copies, a form thickness adjustment device is provided. This device is located behind the print head. Six notches are provided. For heavier impressions, engage the movable lever in one of the lower notches.

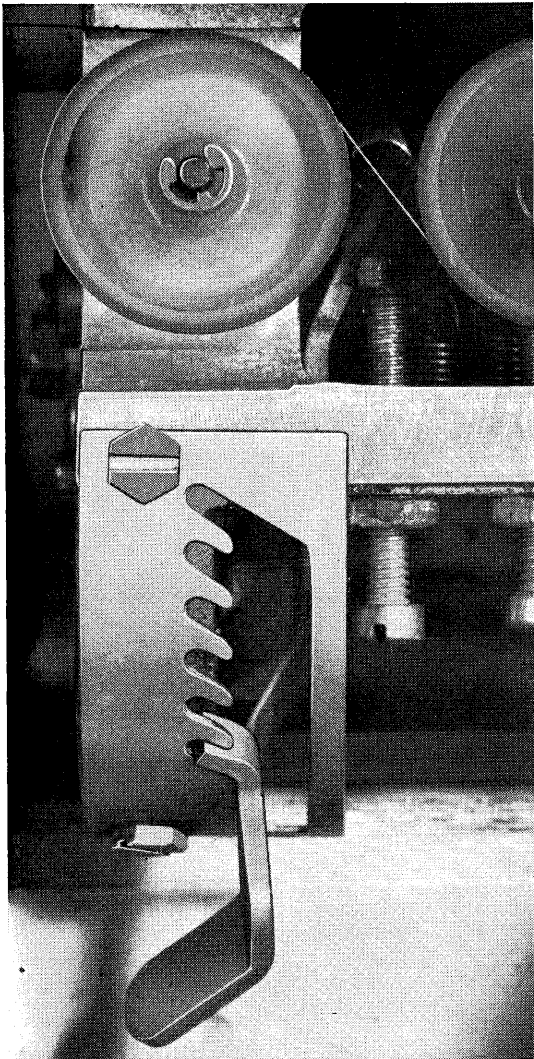
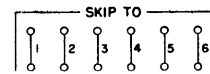

FIGURE 79. FORM THICKNESS ADJUSTMENT DEVICE

FORM CONTROL

SKIPPING is initiated by wiring on the control panel and stopped by holes in the tape. The following examples show operating principles only. Form design will dictate each individual arrangement.



S-T, 21-26

Skip-To. These entry hubs are impulsed from ANALYZER EXITS or from 305 control impulses wired through communication channels to cause the tractor to feed the paper in the printer to the corresponding hole in the control tape. Tape channels 1-6 stop the corresponding skips.

To skip before printing, SKIP-TO on the printer control panel must be impulsed before the PRINT hub on the process control panel is impulsed. If SKIP-TO is impulsed after the print cycle has started, skipping will occur after printing. When skipping is initiated during the analysis portion of the print cycle, the skip will occur after printing.

Figure 80 illustrates skipping before printing.



S-T, 32

OF (overflow). Channel 12 on the tape is reserved for overflow control. It is punched to identify the last printing line on the form. When it is sensed—during the analysis portion of the cycle—an impulse is available out of the OF hub. This impulse may be wired to cause the paper to be skipped to the first line of the following form by impulsing one of the SKIP-TO hubs, and placing a hole in the control tape in that channel to stop the form at the proper place.

The OF impulse may also be wired through communication channels to the processing control panel, where it may pick up a selector that is tested in the course of the program to determine if the overflow condition exists; then steps in the program can decide whether to complete the form or start the following form.

Variable line spacing within the body of a form will require multiple 12 punches in the carriage tape for overflow so that the overflow position will not be bypassed during a double or triple spacing operation.

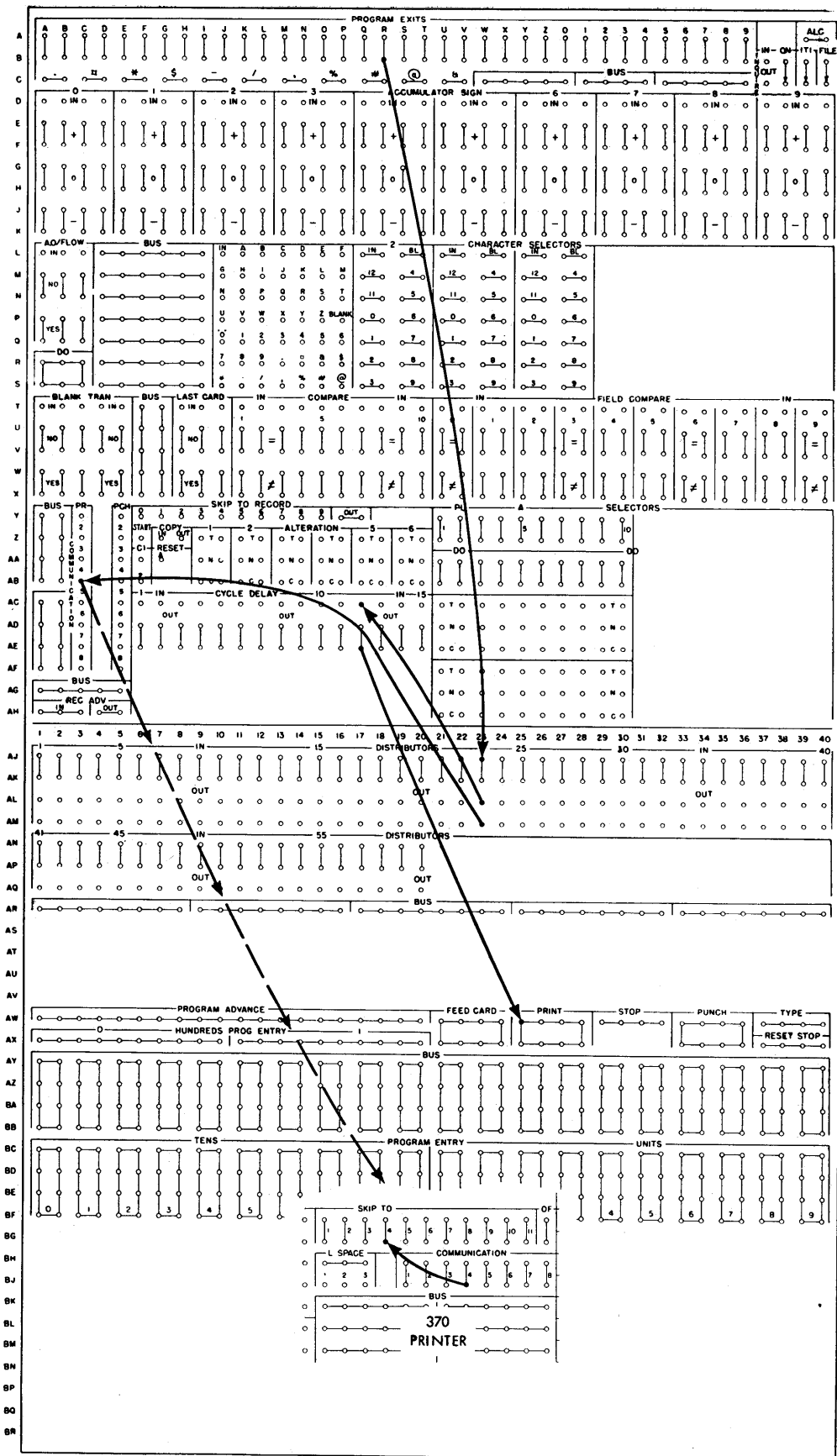

FIGURE 80. SKIP BEFORE PRINT

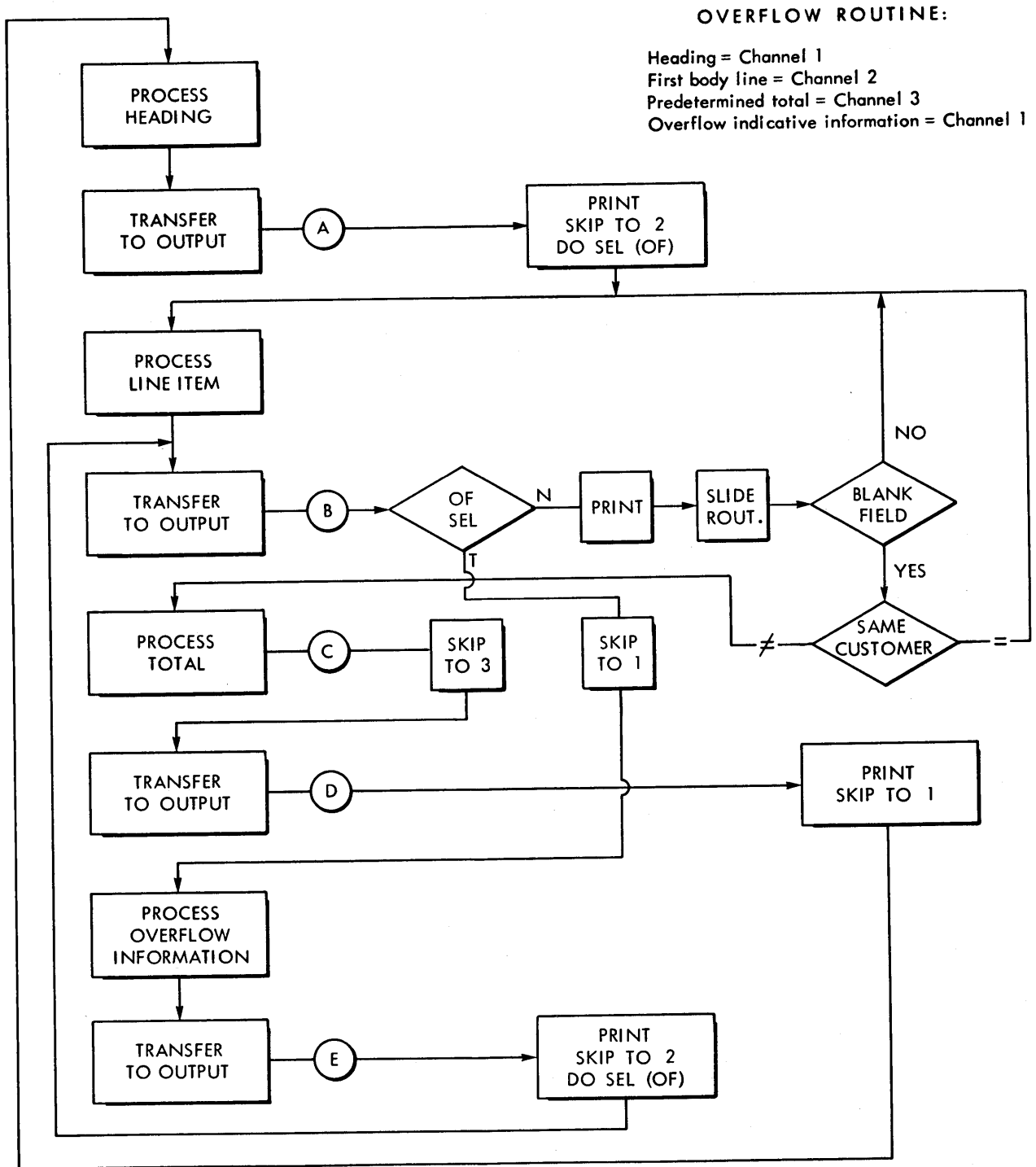

FIGURE 81. PRINTING OVERFLOW INDICATIVE INFORMATION

Printing Indicative Information (Figure 81)

Figure 81 illustrates in block form one method of printing indicative information at the beginning of each new overflow sheet of an invoice. In this example, the stored program is controlled by a selector on the process control panel. The selector is picked up by wiring the overflow impulse through one of the communication channels.

Because spacing occurs after the print cycle has already been initiated—during the analysis portion of the cycle—the last line on the sheet, which corresponds to the overflow line, will have already been set up for printing before the overflow impulse is available. Therefore, the last line on the form will print, but the selector that is picked up by the overflow impulse will be transferred the next time the program reaches that point.

When the overflow selector is tested the next time, the program will be directed to the overflow routine. The form is skipped to the heading location; the overflow indicative information is transferred to the output replacing the body line information; printing is initiated; the overflow selector is dropped out; and the form is skipped to the first body line of the next sheet.

The program is then directed back to a point where the previous body line information is again transferred to the output. The program will then proceed through the path taken when the overflow selector is normal.

The slide routine referred to is included for a typical spread-card and blank-field-check routine.

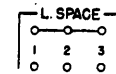

U-V, 21-23

Line Space. The line space hubs 1, 2, and 3 (exit hubs) are jackplugged to the common hubs located directly above them to cause single, double, or triple spacing between lines on a form. If line space 1 is wired, single spacing will occur; if line space 2 is wired, double spacing will occur, etc.

Selective spacing and space suppression may be performed. The ANALYZER EXITS are used to control the selection; however, the selection of triple spacing must be controlled by the early analyzers.

Figure 82 illustrates selective spacing.

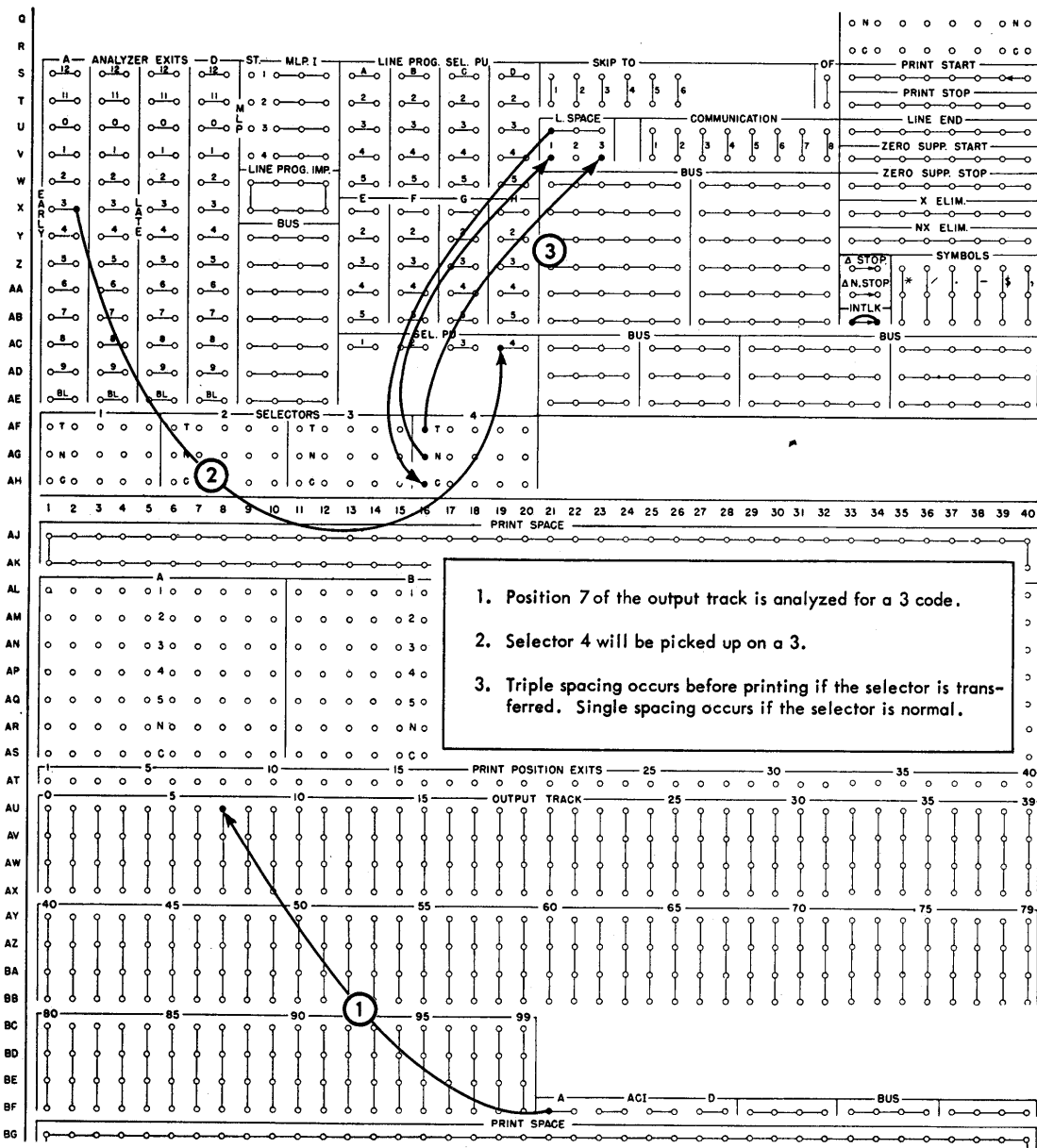

FIGURE 82. SELECTIVE SPACING

GENERAL MANUFACTURING CO.
SAN JOSE, CALIFORNIA

Ship To THE WINSOR CORP.
127 SOUTH EIGHTH ST.
ALBUQUERQUE, NEW MEXICO

Cust. No.	191751
MDY	Inv. No.
12156	1254

Quantity	Description	Item No.	Price Each	Amount
40	SQ. SHANK SWIVEL	11202	83	33.20
75	FLAT TOP RIGID	13102	84	63.00
5	EXT. SHANK WITH BRK.	17203	1.62	8.10
2	BOLT AND NUT SHANK	32105	2.64	5.28
4	RND. SPR. RING STEM	44104	3.51	14.04
40	BOLT AND NUT SHANK	62110	7.25	290.00
	FREIGHT			78
NET AMOUNT				414.40

CUST DISK ADD	MLP	NAME	STREET ADDRESS	CITY AND STATE	DATE	INV. NO.	CUST. NO.
10	1516	30	52	75	85	91	97

FIGURE 83. MLP INVOICE

MULTIPLE LINE PRINTING

PRINTING multiple lines of information from the output track may be accomplished by proper wiring of the MLP unit. The number of lines to be printed are controlled by an MLP code, which may be placed in any convenient output track position as long as that position remains consistent.

To prepare an invoice heading (Figure 83) the output track is normally assembled in several different steps. After it is assembled, a print instruction is initiated. During the analysis portion of the print cycle, the MLP code is analyzed and controls are set for the printing of from one to four lines. The number of lines to be printed is determined by the code. For example, a 1 code may cause one line to print; a 2 may cause two lines to print; a 3 may cause three lines to print; etc.

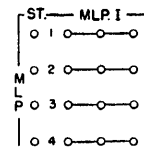

S-V, 9-12

MLP. The MLP unit controls the printing of multiple lines from a single output track. The START hub is impulsed from an ANALYZER EXIT. Then, the MLP impulse, (MLP I) hubs emit an impulse which may be wired to pick up line program selectors.

The impulse wired to the START hub will usually correspond to the desired number of lines of printing; that is, a 1 will initiate a single line of printing, a 2 for two lines, a 3 for three lines, etc. This type of coding is convenient; however, it is not imperative. For example, a seven could cause two lines of printing.

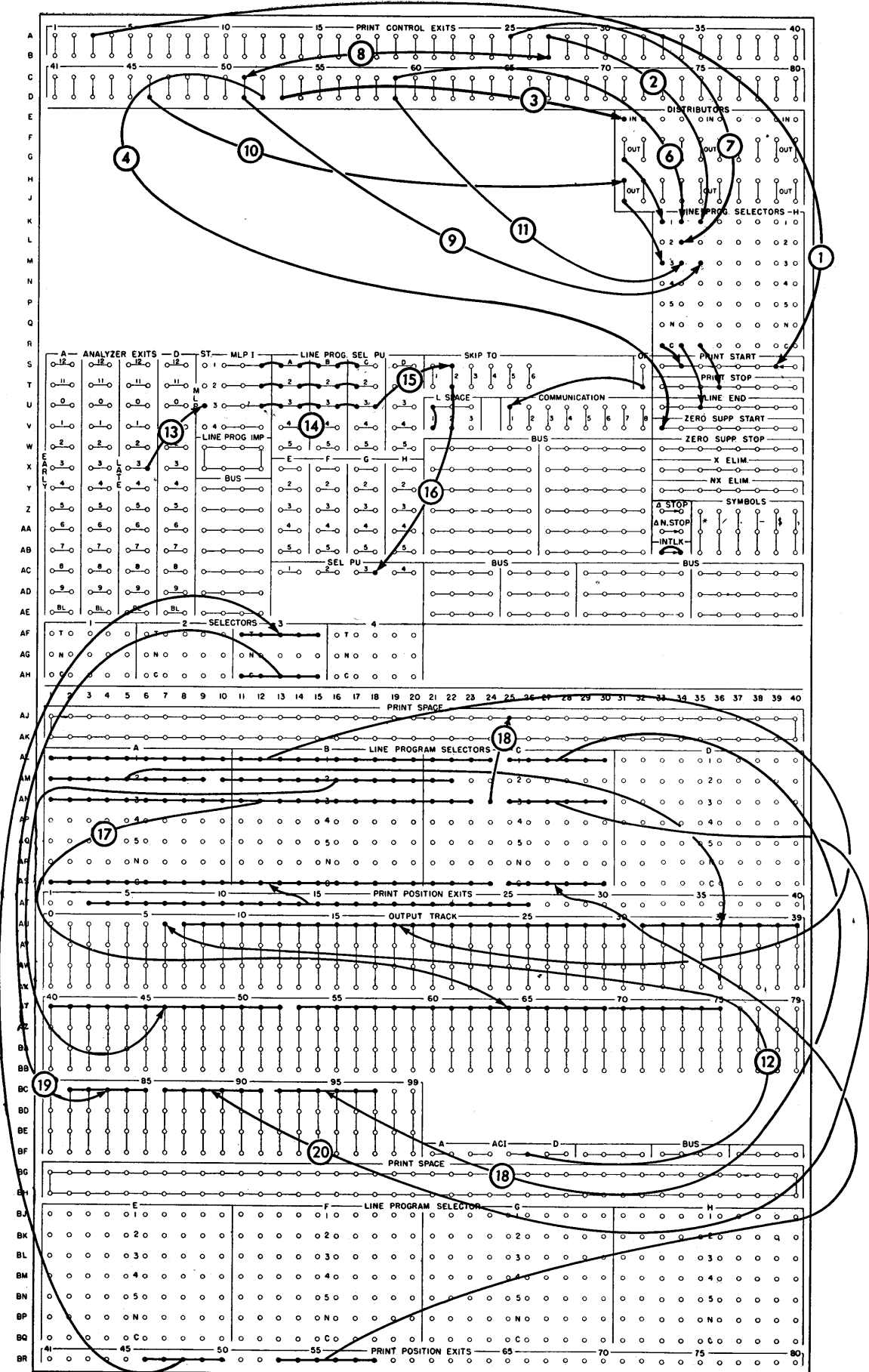

FIGURE 84. MULTIPLE LINE PRINTING

Once the START hub has been impulsed the MLP I hubs will emit in sequence. If the THREE START hub is impulsed, the number one MLP I hub will emit on the first line; then the two hub on the second line; and last, the three hub on the third line. If the number TWO START hub is impulsed, the number ONE and TWO MLP I hubs will emit in sequence.

Figure 84 shows the wiring necessary to prepare the three-line invoice heading shown in Figure 83. In this example, it is assumed that all invoice headings will contain three lines.

Wiring (Figure 84)

First line print control

1. Printing begins in print position 3 (wire 1).
2. Printing is stopped before printing position 27 (wire 2).
3. ZERO SUPPRESSION START is impulsed from PRINT CONTROL EXIT 52 so that it will be on for customer number (wire 4).
4. Printing of customer number begins with print position 53 (wire 3).
5. LINE END is impulsed from position 59 (wire 6).

Second line print control

1. Printing begins in print position 3 (wire 1).
2. LINE END is impulsed from position 25 (wire 7).

Third line print control

1. Printing begins in print position 3 (wire 1).
2. Printing is stopped before printing position 27 by wiring from PRINT CONTROL EXIT 27 to 50, and then through the line program selectors to PRINT STOP (wire 8 and 9).
3. Printing is started in position 46 (wire 10) to start printing date.
4. Printing is stopped before printing position 51 (wire 9).
5. ZERO SUPPRESSION is impulsed from PRINT CONTROL EXIT 52 so that it will be on for invoice number (wire 4).
6. Printing of invoice number begins with print position 53 (wire 3).
7. LINE END is impulsed from position 59 (wire 11).

Analyzer Wiring

1. ANALYZER CONTROL IMPULSE for analyzer C is wired to OUTPUT TRACK POSITION 6 (wire 12). Position 6 contains the MLP code.

2. In this example it is assumed that all invoice headings contain three lines. Therefore, it is only necessary to impulse MLP 3 START (wire 13).

3. Line program selectors A, B, and C for line 1, 2, and 3 are picked up from the MLP IMPULSE hubs (wire 14).

4. After printing the third line of MLP, the form will be skipped to the position corresponding to channel 2 of the tape (wire 15).

5. Selector 3 is picked up to expand the third line of printing (wire 16).

Line Program Selection

1. On the first line of printing, PRINT POSITION EXITS 3-26 are wired through the first line of the LINE PROGRAM SELECTORS to OUTPUT TRACK POSITIONS 7-30. On the second line of printing, PRINT POSITION EXITS 3-24 are wired to POSITIONS 31-52. On the third line, PRINT POSITION EXITS 3-25 are wired to POSITIONS 53-75 (wire 17).

2. Printing is turned off after printing position 26 on both the first and third lines (wire 2). Because, on the third line, an output track position is not wired from print position exit 26, PRINT SPACE must be wired (wire 18).

3. Customer number is directed to print through line one of the line program selectors (wiring 18).

4. Date is directed through selector 3 to print on the third line of MLP (wire 19).

5. Invoice number is directed to print through line three of the line program selectors (wire 20).

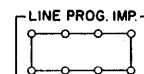

W-X, 9-12

Line Program Impulse. This impulse is available during the analysis portion of the print cycle. It is, however, inactive if MLP START has been previously impulsed. During an MLP operation, the MLP IMPULSE hubs emit, and the LINE PROGRAM IMPULSE hubs are inactive.

The LINE PROGRAM IMPULSE occurs after the C and D ANALYZER EXIT impulses. This arrangement allows the type of selector wiring shown in Figure 85.

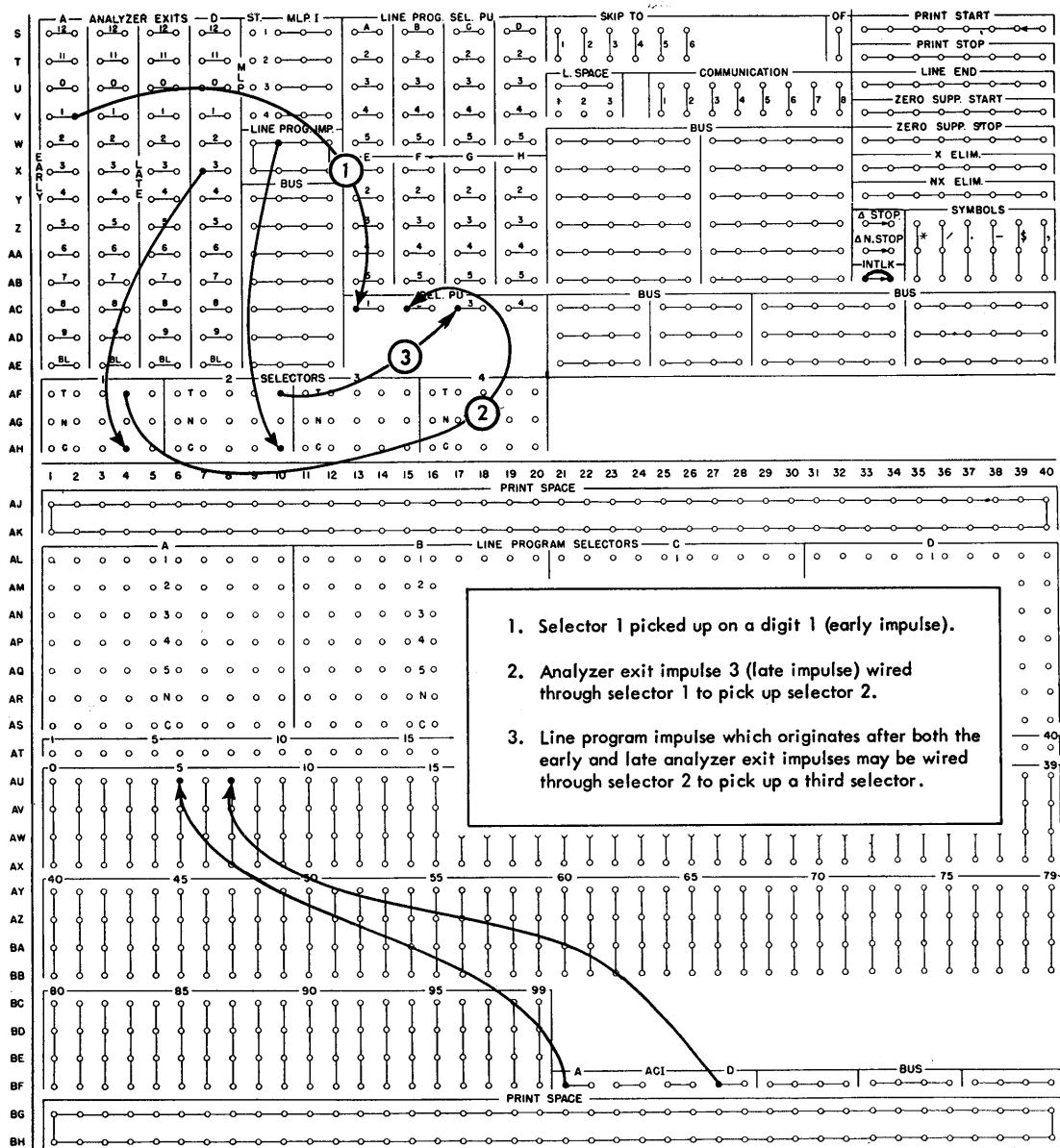

FIGURE 85. SERIES WIRING TO ILLUSTRATE TIMINGS

TIMING CHARTS

THE TIMING CHART and control panel entry summary assist in determining whether doubtful control panel wiring will function without damaging the machine internally. A good working knowledge of the machine is necessary before timing charts can be used effectively. The timing chart should be used in conjunction with the control panel entry summary.

All impulses shown on the timing chart with the exception of the PRINT CONTROL EXITS and PRINT POSITION EXITS happen only once during the over-all print cycle. These impulses which happen only once occur during the analysis portion of the cycle. The analysis portion of the print cycle is completed at

17.5. The first character prints at 19.5. At 32 on the index, the print shaft latches; however, the PRINT CONTROL EXITS and the PRINT POSITION EXITS continue to emit until all 80 characters have been printed or until LINE END on the printer control panel is impuised.

It requires 320 milliseconds to complete the 32-point cycle, or 10 milliseconds per cycle point. This timing relationship may be used as a guide for picking up selectors or directing impulses through the transferred points of the selectors. In general, once a selector has been picked up, seven milliseconds should be allowed before directing an impulse through the transferred points of the selector. Impulses that are active during pickup time should not be selected.

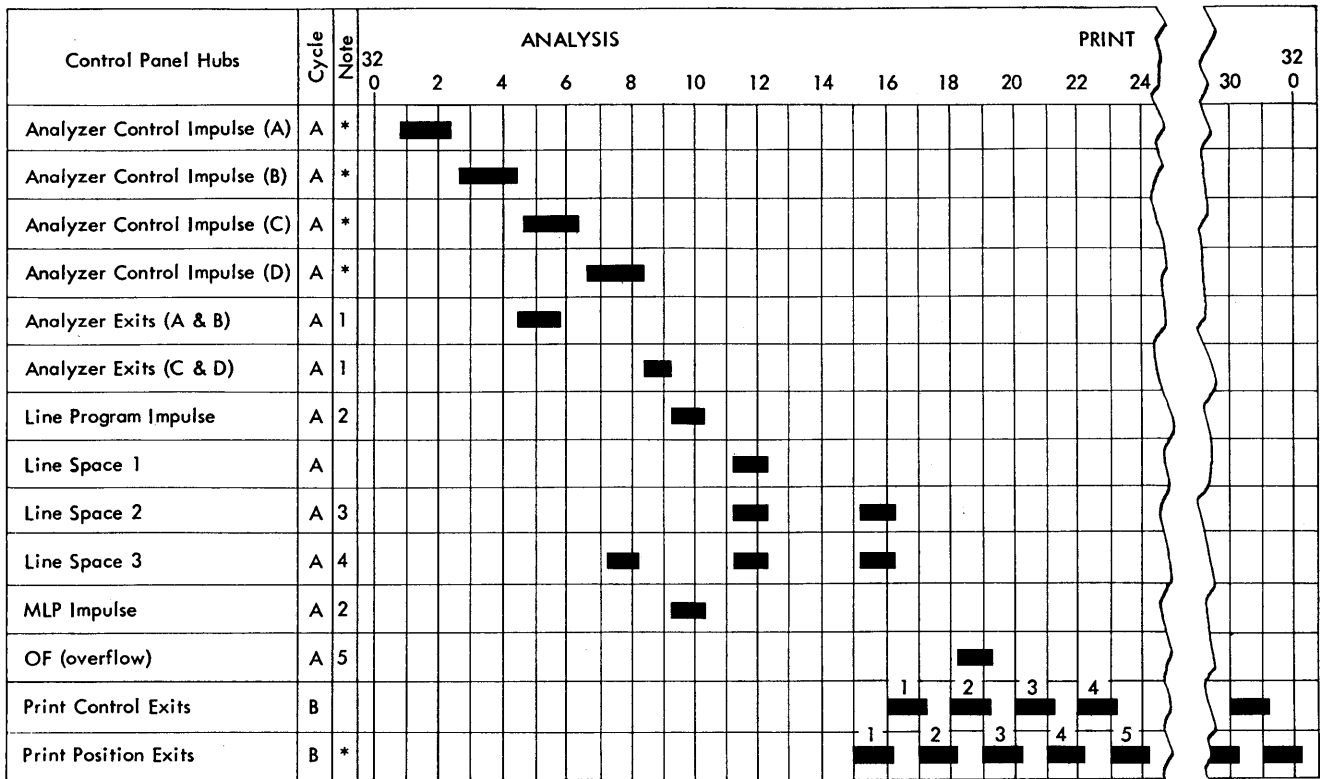

Machine Cycle Code:

- A. Emit only during analysis portion of cycle.
- B. Impulses continue for all 80 print positions.

Notes:

1. Emit if Analyzer Control Impulse hub has been wired to an output track position.
2. If MLP START has been impulsed, LINE PROGRAM IMPULSE is inactive.
3. To select double spacing, selectors must be transferred in time to accept the first impulse.
4. To select triple spacing, selectors must be transferred in time to accept the first impulse.
5. Under control of the carriage.
- * High Level Impulses.

FIGURE 86. 370 PRINTER TIMING CHART

370 PRINTER CONTROL PANEL ENTRIES

CONTROL PANEL HUBS	ENTRY DESCRIPTION
Communication	Accepts whatever is entered.
Distributors	Accepts any low level impulse.
Line End	Wire from any print control exit.
Line Prog. Sel. Pickup	Accepts any low level impulse.
Line Prog. Sel. (Transfer)	Transfer immediately; drop out with line end.
Line Space Common Hubs	Will accept only line space 1, 2, or 3.
NX-Eliminate	Wire from any print control exit.
Output Track	Wire from ACI or print position exit only.
Print Space	Wire from any print position exit.
Print Start	Wire from any print control exit.
Print Stop	Wire from any print control exit.
Selector Pickup	Accepts any low level impulse.
Selector (Transfer)	Transfer immediately; drop out with line end.
Skip-To	Accepts any low level impulse.
Symbols	Wire from any print control exit.
X-Eliminate	Wire from any print control exit.
Zero Supp. Start	Wire from any print control exit.
Zero Supp. Stop	Wire from any print control exit.

3 2 3 C A R D P U N C H

THE IBM 323 Card Punch (Figure 87) may be used as an output device for the RAMAC system, or as an independent gangpunch. Information from the output track is directed by the control panel to punch cards in any desired format.

During continuous operation, up to 100 cards per

minute may be punched. Each card requires six hundred milliseconds.

It is possible to perform gangpunching, double-punch and blank-column detection, column splitting, etc. However, because X-control is not provided, it is not possible to perform operations such as interspersed gangpunching.

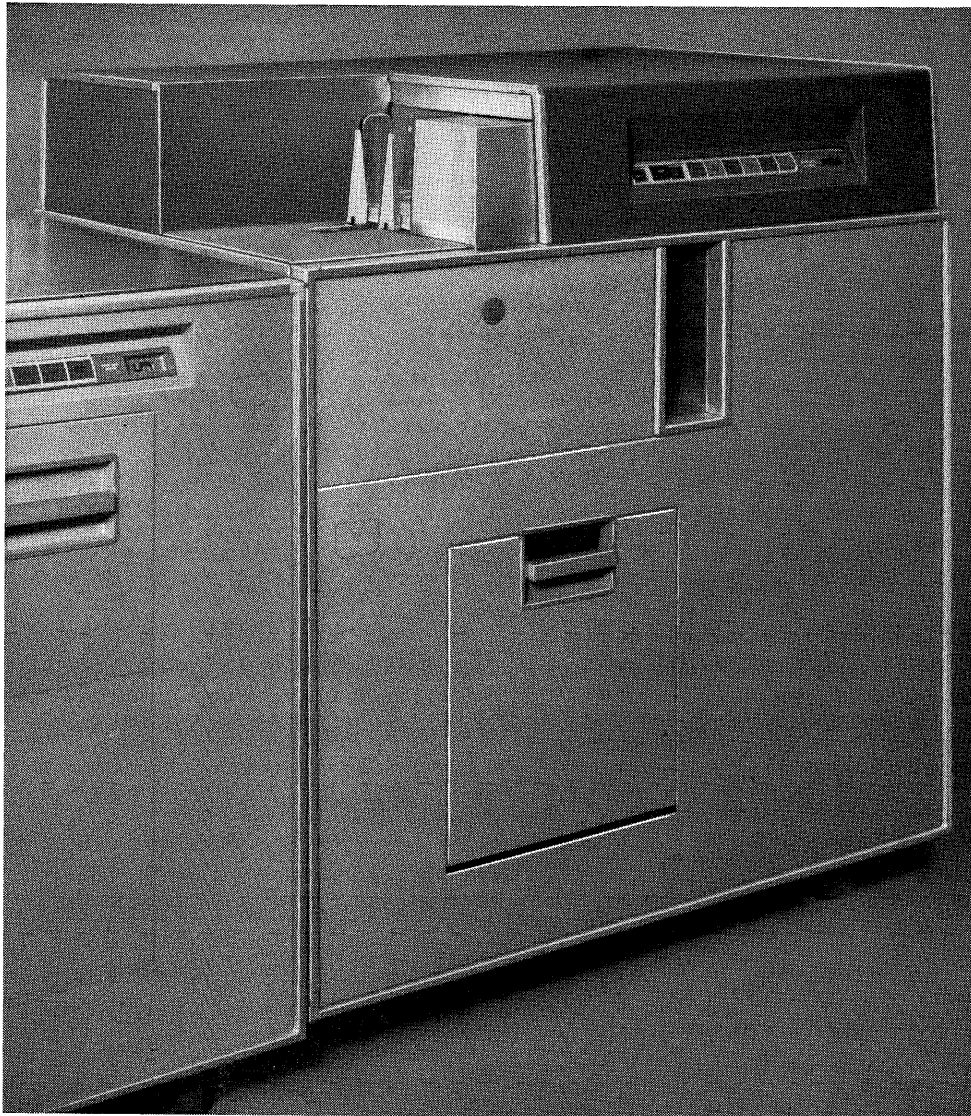

FIGURE 87. 323 PUNCH

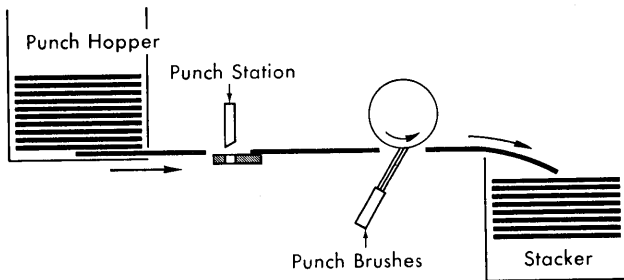

FIGURE 88. PUNCH FEED SCHEMATIC

FEED AND PUNCH UNIT

THE feed is illustrated in Figure 88. Up to 80 characters of information may be punched into each card as it passes the punch station. Gangpunching and double-punch and blank-column detection are performed at the punch brush station.

The initial run-in of cards into the machine—face down, twelve edge first—may be accomplished by holding the start key down until the ready light comes on. However, if the run-in is performed one cycle at a time, a single depression of the start key will feed the first card partially out of the hopper; the second depression of the start key feeds the card past the punch station; on the third depression, the ready light will come on, but the cards do not move. Because one card passes the punch station during run-in before any processing actually takes place, there will always be one blank card preceding each new group of cards.

During continuous operation, the output track is read in its entirety when the card is positioned for punching at each of the zone and numeric portions of the card. For example, when the card is in position to punch all 12 zones, all 100 positions of the output are read; however, only those positions that contain a 12 are selected for punching. This same sequence is repeated when the card is in position for punching the 11 zones, 0 zones, 1, 2, etc.

OPERATING KEYS AND LIGHTS

The following operating keys and lights are located on the punch unit (Figure 89):

Keys

Start

The start key will feed cards into or out of the punch feed. It is also depressed to place the punch in a ready condition if cards are at each station.

Stop

Depressing this key during a punch cycle will stop the punch at the completion of that cycle and remove it from a ready condition. The program or process unit will stop as soon as the program refers to the output track.

Check Reset

Depression of this key will restore the punch-error-detecting circuits. It is used to reset parity, and double-punch and blank-column error indications.

Main Line Power

This switch is used in conjunction with the console power-on key to supply or remove power from the punch.

Lights

Ready

This light will glow when the punch is ready for use by the processing unit. It is turned on by depressing the start key if the card stations are full, and all error-detecting devices have been reset.



FIGURE 89. 323 PUNCH OPERATING KEYS AND LIGHTS

Feed Check

This light indicates a misfeed in the punch feed. If a card failed to feed from the hopper into the machine, remove the cards from the hopper, and run the remaining cards out of the machine. Then proceed through a normal run-in procedure. Misfeeds at the other stations will require individual correction procedures.

Parity

Each of the 100 positions of the output track is parity checked before punching occurs. If any position fails to pass this parity check (including those positions not being punched), the parity light will glow, and the punch will stop at the completion of the punch cycle.

DP & BC

The punch control panel may be wired to stop the machine and turn this light on when either a double-punch or a blank-column error is detected.

Power-On

When ac and dc power have been supplied to the punch, this light will glow.

323 CONTROL PANEL

The following hubs are located on the punch control panel (Figure 90):

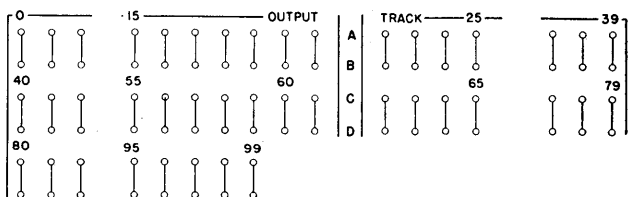

A-D, 1-40
E-F, 1-20

Output Track. Each of these 100 hubs correspond to a position of the output track. The hubs emit information in the standard IBM punched-card code form. These exits are wired to the PUNCH MAGNETS to cause punching. This allows any of the 100 output track positions to be punched into any of the 80 card columns.

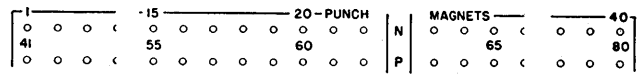

N-P, 1-40

Punch Magnets. These hubs are entries to the 80 punch magnets that punch the correspondingly numbered columns of the card. These magnets are wired from the OUTPUT TRACK positions that are to be punched.

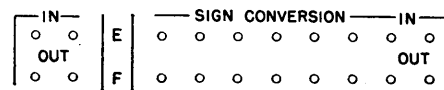

E-F, 21-30

Sign Conversion. Within the RAMAC system the 12 card code is recoded by a combination of X- and 0-bits. Also, sign control on negative fields is maintained by carrying an X-bit over the low-order position. If the low-order position of a field is zero and the field is negative, a 12-hole would be punched if this position were wired directly to a punch magnet. The sign conversion hubs are provided so that the 12-impulse available from the output track may be converted to the X/0 code desired for these positions.

In use, the low-order position of any numerical field that may be negative is wired from the output track to an IN hub and from the corresponding OUT hub to the punch magnet. If a 12-code is emitted from this position of the output track, it is punched as X/0. Any other negative number is overpunched with an X. Positive numbers pass through without conversion.

Figure 91 illustrates the type of wiring necessary to punch output information. If there is a possibility of the output track containing a negative figure, the units position should be wired through sign conversion.

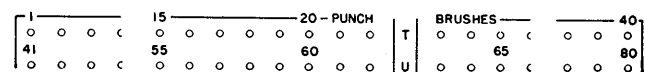

T-U, 1-40

Punch Brushes. On the punch cycle after it is punched, a card passes a set of 80 reading brushes that read back the information that has been punched so that it may be given the double-punch blank-column check. These hubs are the exits for the reading on this cycle. The information may also be gangpunched back into the following card.

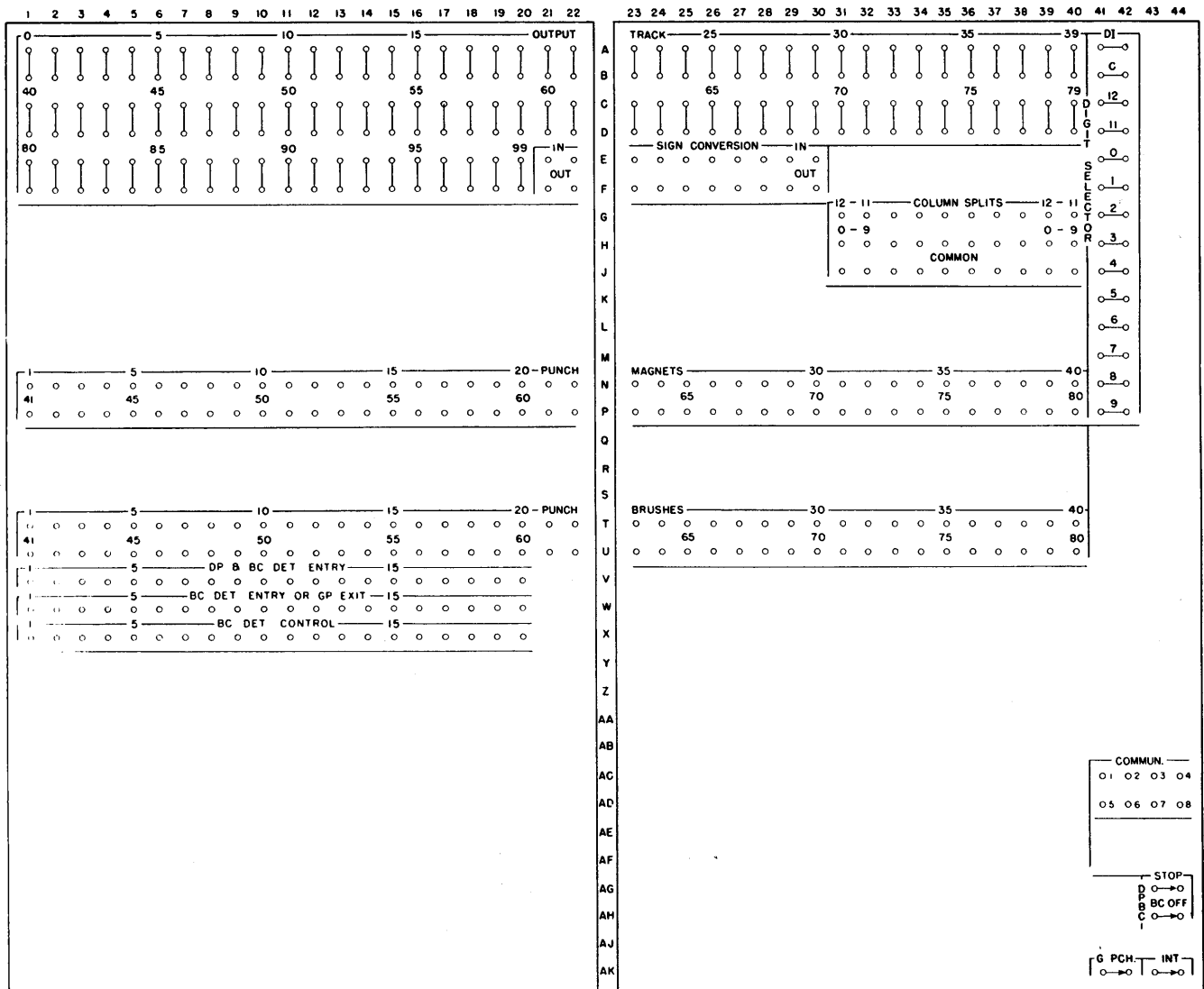

FIGURE 90. 323 PUNCH CONTROL PANEL

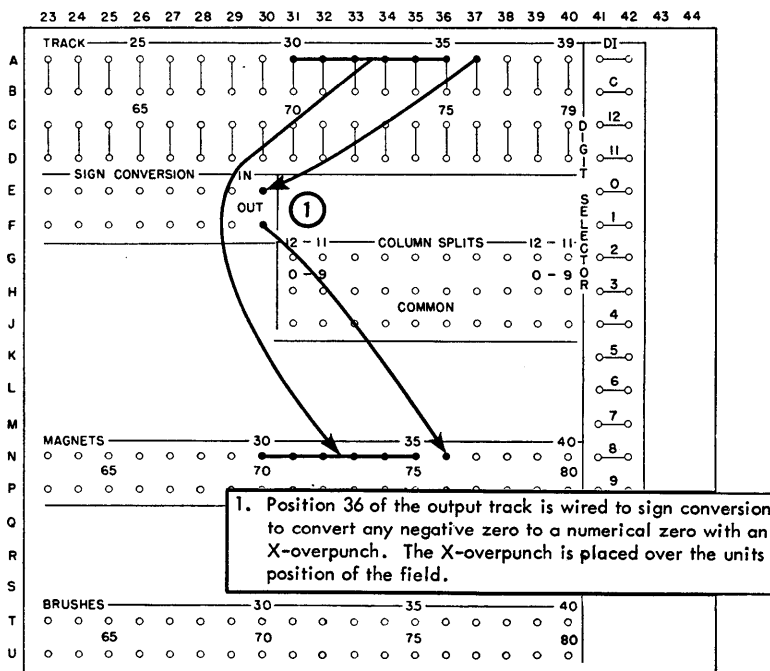
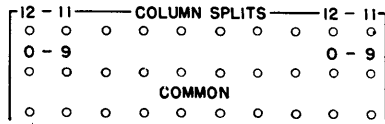

FIGURE 91. SIGN CONVERSION



G-J, 31-40

Column Splits. This is a 10-position selector that is automatically controlled to transfer between X and 0 time as each card is punched. This allows the separation of the digits 0-9 from the 12- and X-zones. For example, if the character A were wired to the common of a COLUMN SPLIT position, the numeric digit 1 would emerge from the 0-9 hub, and the 12-zone would be available at the 12-11 hub.

Figure 92 illustrates a method of using the COLUMN SPLIT device to punch an X over the high-order position of a field.

Double-Punch and Blank-Column Detection

The 323 Card Punch is equipped with 20 positions of DPBC detection as a standard feature. By appropriate control panel wiring, it is possible to detect the presence of either multiple punches in any single column or the absence of any punch in a column or both.



AH, 43-44

BC OFF (blank column off). When this switch is wired, blank columns will not be detected by the DPBC device.

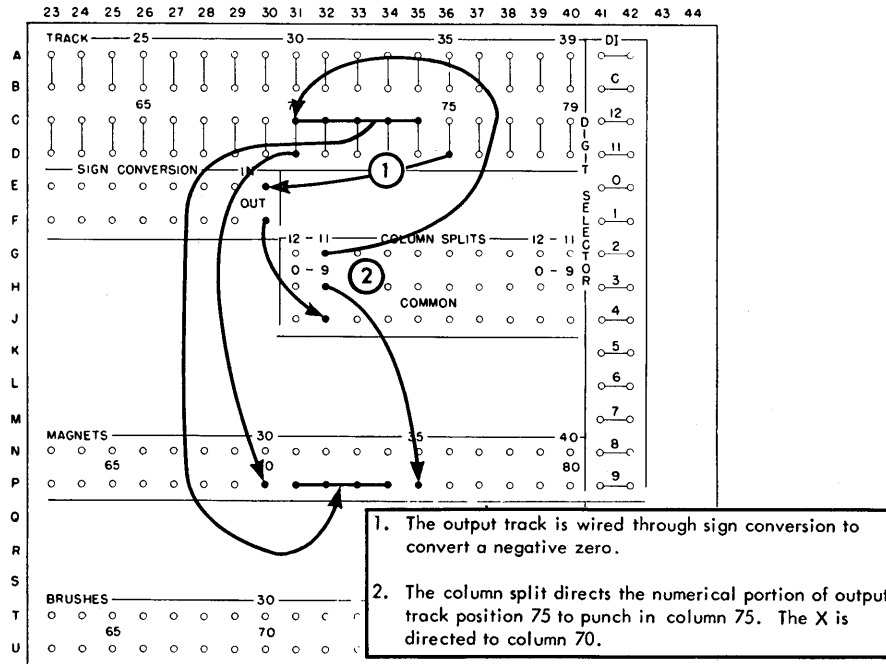
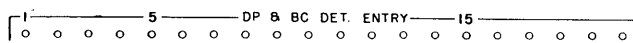

FIGURE 92. PUNCH NEGATIVE X OVER HIGH-ORDER POSITION



V, 1-20

DP & BC Det Entry (double-punch and blank-column detection entry) Figure 93. These hubs are entries for the digit impulses from the punch brushes. They are used to detect double-punched or blank columns in the output cards.

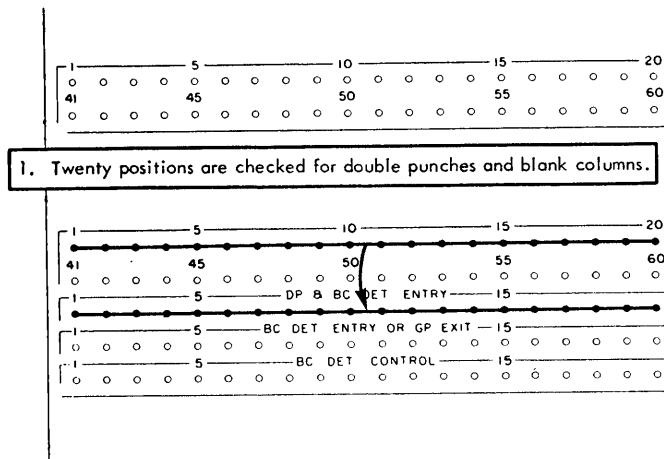

FIGURE 93. DPBC DETECTION



W, 1-20

BC Det Entry or GP Exit (blank-column detection entry or gangpunch exit) Figure 94. These hubs may be either entries or exits. As entries, they are used to detect blank columns in the output cards without double-punch detection.

As exits, they are wired to the punch magnets for gangpunching. When used as gangpunch exits, only the first digit of any column wired to a DP or BC DET ENTRY hub will be available at the associated GP EXIT hub.

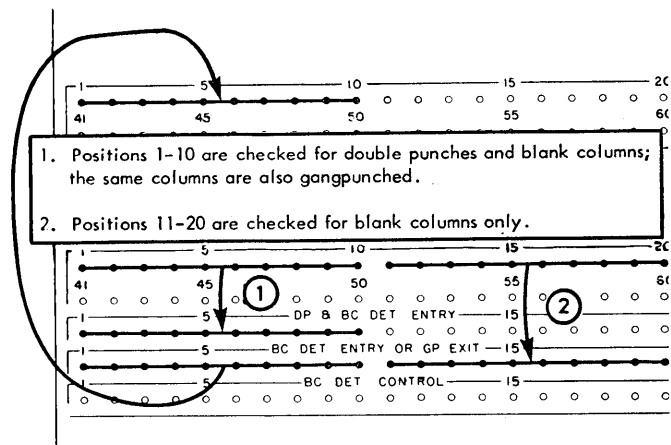

FIGURE 94. DPBC AND BC-ONLY DETECTION



X, 1-20

BC Det Control (blank-column detection control) Figure 95. These hubs provide a means for control of blank column detection. All positions of DPBC are internally connected for blank-column detection. It is possible to bypass any particular position or positions that are not to be checked for blanks by control panel wiring in the following manner: The BLANK-COLUMN DETECTION CONTROL hub for the last position, in which blanks are to be checked, is connected by a control panel wire to the BLANK-COLUMN DETECTION CONTROL hub preceding the next position which is to be checked for blanks.

If it is necessary to bypass checking for blanks in the last position (position 20 for standard machine), the BC DET CONTROL hub for the last position in which blanks are to be checked must be connected by a control panel wire to the BLANK-COLUMN DETECTION CONTROL hub of the last DPBC position.

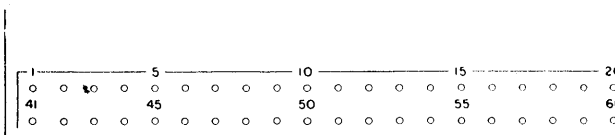

FIGURE 95. DPBC AND DP-ONLY DETECTION



AG, 43-44

DPBC Stop (Figure 96). When this switch is plugged, either (or both) a blank-column or a double-punch error will stop the machine. The DPBC light on the punch will be turned on. In addition, the interlock and punch select light will be turned on at the 380 console.

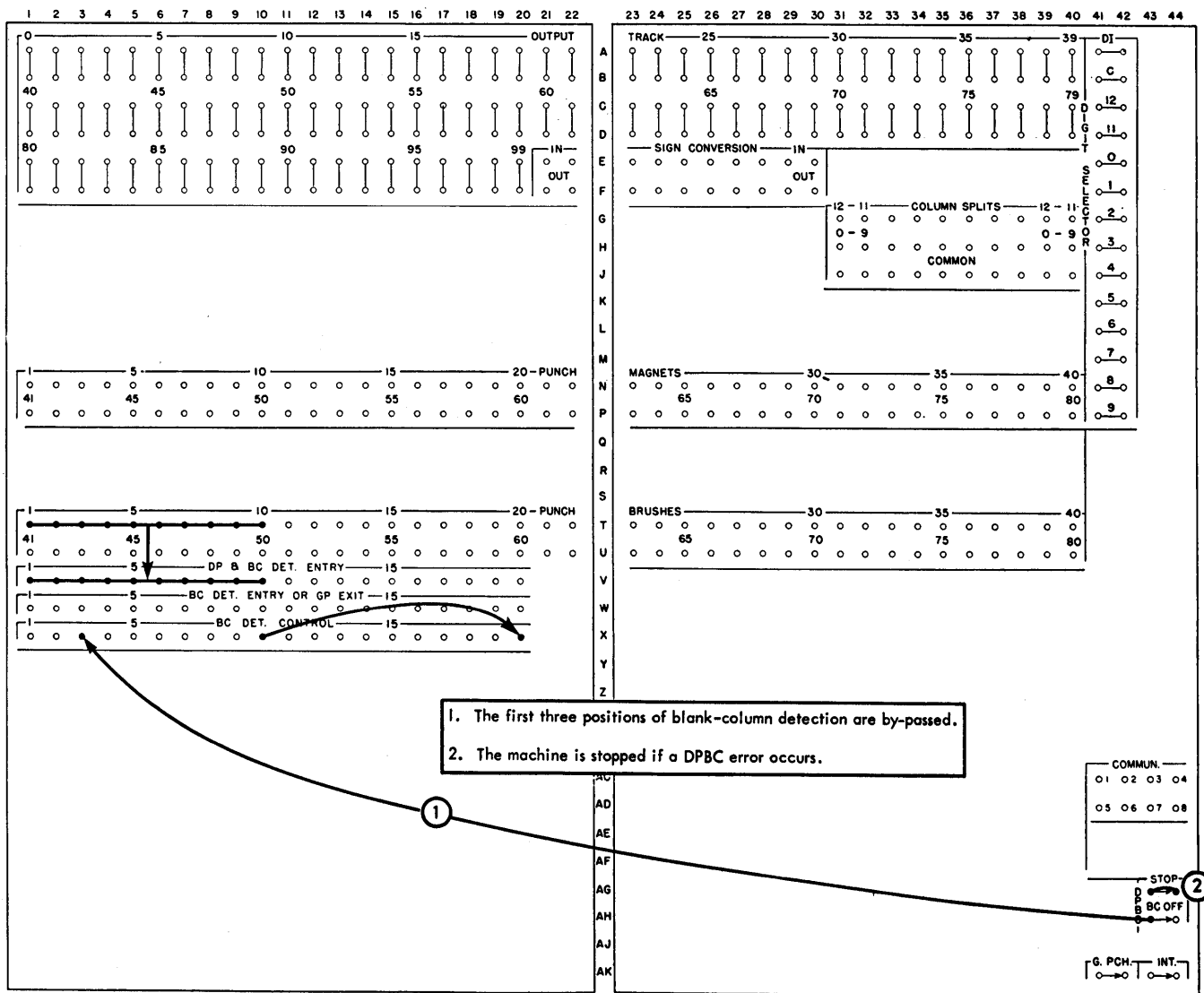
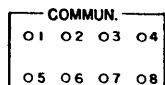

FIGURE 96. DOUBLE-PUNCH AND BLANK-COLUMN DETECTION

Other Control Panel Functions



AC-AD, 41-44

Communication. These hubs are connected to the correspondingly numbered hubs labeled *Punch Communication* on the process control panel.



AK, 41-42

G. Punch (gangpunch). When this control-panel switch is jackplugged, the 323 punch is removed from the control of the processing unit and may be used as an independent gangpunch.



AK, 43-44

Int. (interlock). Whenever the punch is to be used to punch output cards for the processing unit, this control-panel switch must be jackplugged. It is not plugged if the punch is to be used for independent operation.



A, 41-42

DI (digit impulse). This hub emits all digit impulses (12 through 9) every punch feed cycle.

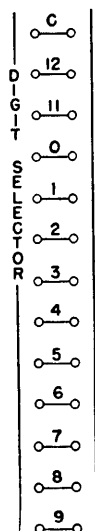

B-P, 41-42

Digit Selector. One digit selector is standard with the 323 punch. It may be used to separate or combine multiple digits. In addition, it may be used to select specific digits from the output track or punch brushes.

When the DI impulse is connected to the common of the digit selector, it becomes a punch digit emitter with a 12 impulse available out of the 12 hub, 11 impulse at the 11 hub, etc.

Figure 97 illustrates using the digit selector as a digit emitter.

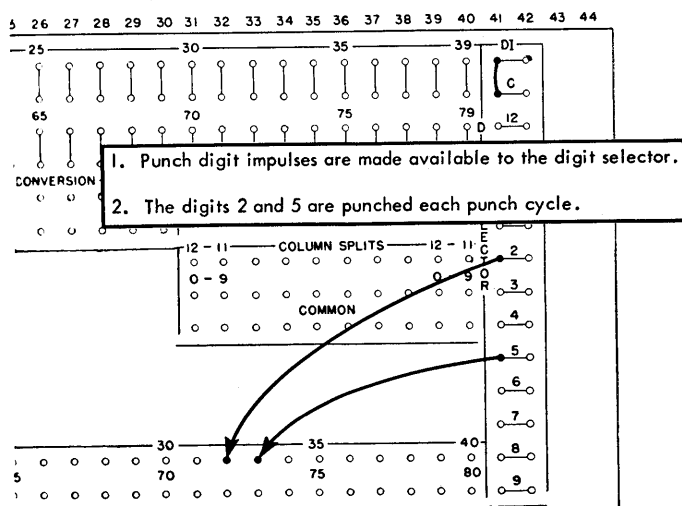

FIGURE 97. DIGIT EMITTING

ERROR-CORRECTION PROCEDURES

THE following error-correction procedures are presented as an aid to the operator. They include feed check, parity errors, DPBC errors and a punch interlock condition. In addition, a run-out and run-in procedure is included.

Feed Check

This stop indicates a full stacker, an empty hopper, or a feed failure. If the condition is caused by a full stacker or an empty hopper, operation may be resumed by removing the cards from the stacker or placing cards in the hopper. Then the punch start key is depressed. A feed failure can be either a failure to feed from the hopper, or a failure to feed from the punch station to the punch brush station. The following procedures can be used if a feed failure occurs:

MISFEED FROM HOPPER

1. Remove cards from hopper.
2. Depress start key to clear feed.
3. Remove the last punched card.
4. Replace the unpunched cards in the hopper. If necessary, a gangpunch master card precedes these cards.
5. Depress the start key. The last punched card which was removed (step 3) will be repunched, because the information concerning this card is retained on the output track.

FAILURE TO FEED INTO PUNCH BRUSH STATION

1. Remove cards from hopper.
2. Remove any damaged cards and clear the feed.
3. Remove the last punched card.
4. Replace the cards in the hopper. If necessary, a gangpunch master card precedes these cards.
5. Depress the start key. The last punched card which was removed (step 3) will be repunched because the information concerning this card is retained on the output track.

Parity Error

Each of the 100 positions of the output track is parity-checked before punching occurs. If any position fails to pass this parity check (including those positions not being punched), the parity light will be turned on and the punch will stop at the conclusion of the punch cycle. In general, the operator should examine the output track and then restart the punch. Either of the following procedures may be used.

RESTART WITHOUT CLEARING THE FEED — CORRECT LATER

1. Depress the 380 console check reset key.
2. Read the output track. All 100 characters on the S track are typed, and, if the track contains an error, it will be automatically underlined.
3. Depress program start.
4. Remove the cards from the punch stacker, and depress the punch check reset and start keys. The second card to reach the stacker is the card in error, and it may be corrected manually.

CORRECT THE ERROR, THEN RESTART

1. Depress the 380 console check reset key.
2. Read the output track. All 100 characters on the S track are typed, and if the track contains an error, it will be automatically underlined.
3. After the full track has been typed, depress the alter key. This will cause the typewriter to space across the page and stop under the first invalid character.
4. Type any corrections that are required.
5. Depress the clear key after the last correction has been completed.
6. Depress the write key.
7. Depress program start.
8. Remove the cards from the 323 punch hopper, and depress the punch check reset key. Then run the remaining cards out of the machine.
9. Remove the last punched card.
10. If necessary, a gangpunch master card precedes these cards. Proceed through a normal run-in. The last punched card which was removed in step 9 will be repunched, because the information concerning this card is retained on the output track.

DPBC (Double Punch Blank Column)

The punch control panel may be wired to stop the machine and turn the DPBC light on when either (or both) a double-punch or a blank-column error occurs. When this type of error is signaled, the card in error has passed the punch brush station. The error can indicate that either the output punching is incorrect, or that an error occurred in a gangpunched field. If the output punching is at fault, it may be necessary to reconstruct the output, because the information in error has been replaced with the following record. This can usually be accomplished by investigating the file or processing drum tracks or by checking the printed document. In some cases it may be desirable to carry duplicate tracks containing output information so that one track will always contain information identical to the preceding output record. Then the operator can investigate the processing unit and correct the card manually.

If the DPBC stop was caused by gangpunching, the feed must be cleared and the operation restarted. Two methods for restarting the punch after a DPBC stop are:

METHOD 1

1. Depress the punch check reset key.
2. Depress the punch start key. Continuous operation will be resumed unless the error occurred in a gangpunched field. The first card to reach the stacker after depressing the start key is the card in error. It must be corrected manually.

METHOD 2

1. Remove the cards from the hopper.
2. Depress the punch check reset key.
3. Depress the start key to clear the feed. The first card to reach the stacker after depressing the start key is the card in error. It must be corrected manually.
4. Remove the last punched card. The information concerning this card will be retained on the output and will be repunched after restarting.
5. If necessary, a gangpunch master card precedes the remaining unpunched cards. Depress the start key to resume operation.

Punch Interlock

A punch interlock condition is indicated when the machine has stopped, and the interlock and punch select lights at the 380 console are on. No error indication lights will be on at the punch. This condition can arise if the punch control circuits should fail to operate properly. It is recommended that the following procedure be used:

1. Depress the punch start key. If the punch resumes operation, this procedure is all that is necessary.
2. Depress the punch start key. If the punch does not resume operation, proceed as follows:
 - a. Remove the cards from the hopper.
 - b. Clear the feed.
 - c. Remove the last punched card. The information concerning this card is retained on the out-

put track, and will be repunched after operation is resumed.

- d. Replace any gangpunch master card if necessary, and run cards back into the machine by depressing the start key.

Clear Feed and Restart — No Error

If the operator wishes to clear the cards out of the punch feed and then restart, the following procedure may be used:

1. Remove the cards from the hopper.
2. Depress the start key to clear the feed.
3. Replace cards in the hopper.
4. Depress the start key. In this case the output record will not be repunched on run-in.

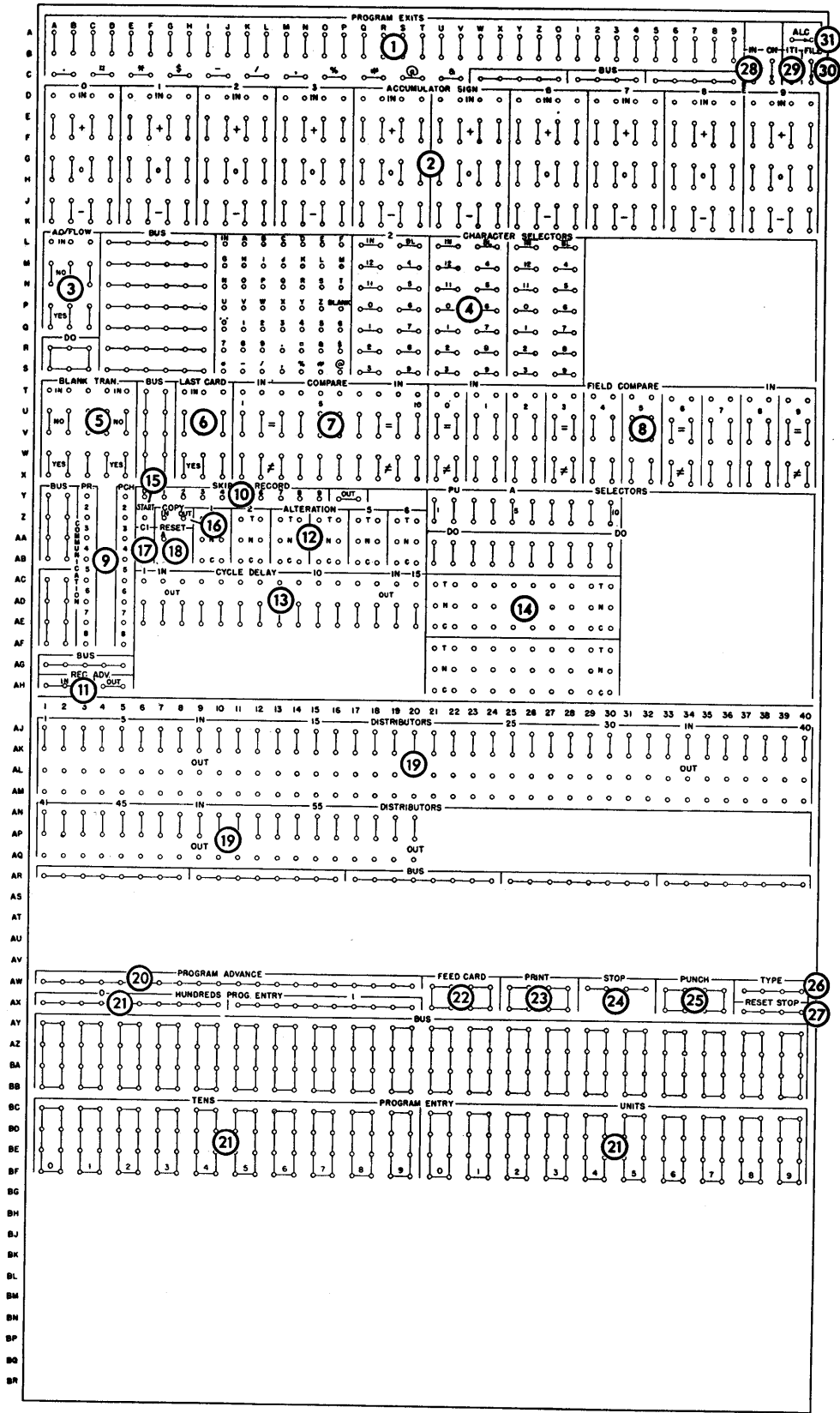

FIGURE 98. 305 PROCESS CONTROL PANEL

CONTROL PANEL SUMMARY

EACH section of the control panels is assigned a number under which the hubs are briefly described.

Process Control Panel (Figure 98)

1. *Program Exits.* These hubs emit an impulse whenever the corresponding control code occurs in an instruction. The impulse is used to make tests on the control panel, and to transfer the program control to the first step of a new sequence of instructions. When one of these hubs emits, the program sequence is halted, and must be restarted by impulsing PROGRAM ADVANCE or by impulsing PROGRAM ENTRIES.

2. *Accumulator Sign.* Each accumulator has an associated selector that shows its sign. By using a PROGRAM EXIT impulse, a test may be made to determine if an accumulator is positive, stands at zero, or is negative.

3. *Accumulator Overflow.* Whenever an accumulator overflows (tries to accumulate a number beyond its capacity), a path is established between each IN hub and its YES hub. These paths remain set up until the accumulator overflow selector is dropped out by impulsing DO. A normal path is established between the IN hub and the corresponding NO hubs when the selector is dropped out or when no overflow has occurred.

4. *Character Selectors.* The character selector provides a way of analyzing any character on a drum track. The position to be analyzed is entered into this unit by an instruction with the hyphen (-) as the TO address. Any character thus entered establishes test paths between each IN hub and the exit hubs corresponding to the character entered.

Four distinct paths are set up on the basic machine. Three of the paths are arranged so that a test impulse entered into the IN hub emerges from the hubs corresponding to the IBM card code of the character being tested. In the fourth path, an impulse wired into the IN hub emerges from one of the 48 exit hubs representing the specific letters, numbers, and special characters (including blank). The

test paths remain set up until another character is addressed to the unit.

5. *Blank Transmission.* This device monitors every information transfer and establishes a path between each IN hub and the YES hub beneath it if no significant information is transferred. If significant characters are transferred, paths are established between the IN hubs and the NO hubs. Non-significant characters are zero and coded blanks only. The selector must be tested immediately after the transfer, using a PROGRAM EXIT impulse, because the next transfer sets up a new reading in the indicator.

6. *Last Card.* This selector is used to control machine operation on the run-out. Normally, a path exists between each IN hub and the NO hub beneath it. When the cards have run out of the card reader hopper, and the last card has passed the second reading brushes; if no more cards are to be entered, the operator may depress the reader start key, and feed the last cards to the stacker. After the start key has been depressed, the last card selector transfers. The program control may be wired through this selector to control the run-out.

7. *Compare.* This selector stores the result of the last programmed comparison. A path is set up between each IN hub and the = (equal) hub beneath it whenever the two fields are exactly equal, and between the IN hubs and their \neq (not equal) hubs when the two fields fail to compare. These paths remain set up until another programmed comparison is made.

8. *Field Compare.* The field compare device is provided to allow, with one instruction, from one to ten fields on the track specified by the FROM address to be individually compared with the fields of a track specified by the TO address. The FROM address may refer to a process drum track, a disk track, or the core unit. The TO address may specify any process drum track other than the accumulator track. Neither the core unit nor the disk file may be used as the TO address. A 2 code is placed in the tenth position of the instruction to cause automatic field comparing. The results of a field comparison will be indicated in the ten selectors associated with the field compare device.

9. *Communication.* These hubs are connected to the correspondingly numbered hubs of the communication section on the printer and punch control panels. They allow for signal communication between the machine units.

10. *Skip-To Record.* When one of the numbered hubs associated with skip-to record is impulsed, the access arm remains on the same disk and track, but the disk address register is advanced so that the units position of the disk address corresponds to the number of the hub impulsed.

After the corresponding address has been set up in the address register, the OUT hub emits. This impulse may be used in the same manner as a PROGRAM EXIT impulse to transfer the program to any desired step, or to restart the program. Normally, this device will be used in conjunction with FIELD COMPARE.

11. *Record Advance.* These standard hubs advance the address in the address register one sector per impulse. This feature is used mainly to obtain additional sectors where a record is spread over more than one sector. When the IN hubs are impulsed, the address in the address register is advanced one sector on the same track. When the advance is completed, the OUT hubs emit an impulse that may be used in the same manner as a PROGRAM EXIT impulse to transfer the program to any desired step, or to restart the program.

12. *Alteration.* A row of switches on the operator's panel at the console is provided to allow various changes to be made in the program setup by changing the settings of the switches. On the control panel, these switches are wired in a manner similar to selectors. Program exit impulses wired into the IN hubs emerge from the N (normal) hub of the same vertical row if the corresponding toggle switch is in the normal position. They emerge from the T (transferred) hub if the toggle switch is transferred.

13. *Cycle Delay.* These units provide a delayed impulse that may be used for control functions, such as the pickup and dropout of selectors. An impulse wired into the cycle delay IN hub emerges from the OUT hub thirty milliseconds later, where it may pick up or drop out selectors after the control impulse has ended.

14. *Selectors.* Latch-type selectors are furnished to provide for storage and for analysis of control. Each selector position has a COMMON, a NORMAL and a TRANSFERRED hub. The COMMON hub is connected to the NORMAL hub until the selector is picked up by impulsing the PICKUP hub. Then the COMMON hub is connected to the TRANSFERRED hub until the DROP-OUT hub is impulsed.

15. *Start.* When the first input card after any runout except non-process runout has been read and checked, an impulse is emitted from this hub. This impulse is used in the same manner as the PROGRAM EXIT impulse to start the stored program at the desired instruction.

16. *Copy.* When the COPY IN hub is impulsed, the machine automatically transfers the available input track to track I of the program storage tracks. If the input card is punched with instructions, this records instructions 190-197 on track I. The IN hub is usually impulsed from the START hub.

When the transfer to track I is completed, the OUT hub emits an impulse that may be wired to start the stored program at any step. Usually it is wired to start the program at step 190.

17. *CI (Control Impulse).* Two buttons are provided on the operator's panel at the console to allow a control impulse to be emitted on the control panel. This allows the operator to pick up or drop out selectors, or initiate other functions from the console. These impulses are emitted from the correspondingly numbered CI hubs on the control panel.

18. *Reset.* When impulsed, this hub causes the group of ten selectors to be dropped out.

19. *Distributors.* Impulses that are used to initiate several functions are wired through distributors that serve the same function as split wires but prevent possible back circuits. An impulse wired into the IN hub of a distributor is available at the associated OUT hubs, but impulses cannot travel between OUT hubs, or from an OUT hub to the IN hub. Any impulse except that from the OUT hub of another distributor may be wired through a distributor.

20. *Program Advance.* The stored program sequence is halted when the control is brought to the control panel as an electrical impulse. To restart the program at the next higher step, the PROGRAM EXIT impulse is wired to impulse PROGRAM ADVANCE.

21. *Program Entry.* When the program control has been brought to the control panel on a PROGRAM EXIT, a new program sequence may be started by impulsing the appropriate program entries.

The hundreds program entry is impulsed only when it is desired to change program steps from steps below number 100 to steps above 100, or vice versa.

The new program step is set up by impulsing the tens and units hubs that correspond to the number of the program step desired. Distributors should be used.

22. *Feed Card.* Impulsing these hubs causes the card reader to feed a card past each station. The card passing first reading is automatically coded and recorded on one input track, while the card passing second reading is checked against the recording on the other input track that was recorded from that card on the previous card-feed cycle. When the card passing second reading has been checked, its input track is made available to the processing unit.

23. *Print*. Impulsing these hubs causes the printer to start and print from the output track. Format control on the printer determines the arrangement of the printing.

24. *Stop*. When these hubs are impulsed, the program will stop. It may be restarted by depressing the program start key.

25. *Punch*. Impulsing these hubs causes the 323 Punch to punch from the output track. Wiring on the punch control panel determines which columns are punched.

26. *Type*. When the typewriter at the console prints an auxiliary document, impulsing these hubs causes the typewriter to print the information recorded on the Q-track. Format control on the typewriter control panel determines the arrangement in which this information is typed.

27. *Reset Stop*. These hubs may be impulsed from a stored PROGRAM EXIT impulse when processing is to be temporarily halted. Impulsing these hubs resets the processing unit and places the machine in an inquiry-only mode of operation so that manual inquiries may be made. Restart by depressing the start key.

28. *Inquire*. The pair of hubs marked *On* form a switch that is jackplugged if manual inquiries to the disk records are to be allowed.

The IN-OUT hubs form an interlock that is wired to allow the console to take control of the access arm at a time when it will not countermand the stored program instructions. The INQUIRE interlock is wired in the program at a point where the access arm has completed its use of the record, and is ready to move the access arm to some other record. If the arm is about to be moved by the program, no harm will be done if the operator moves the access arm to some other record to make an inquiry. When the record has been obtained for the operator, the stored program resumes control and moves the arm to the next record required.

A control impulse wired into the IN hub emerges immediately from the OUT hub if no inquiry has been set up at the console. The impulse from the OUT hub is wired to initiate the next program step.

The operator initiates an inquiry by depressing one of the three keys, format 1, 2, or 3 on the keyboard at the console. The next time the program reaches the point where the control impulse enters the IN hub, it does not emerge from the OUT hub to continue the program, but instead lights the inquire light on the console. Now the operator keys the 5-digit disk address; the access arm moves to the desired record and reads this record to the typewriter Q-track automatically. When this has been done, the machine emits an impulse from the INQUIRY OUT hub to restart the stored program. The program proceeds while the requested record is typed from the Q-track by the typewriter.

29. *ITI (Inquiry-Type Interlock)*. The typewriter may be used to make manual inquiries to the disk records as described in item 28. The typewriter may also be used as a secondary output printer by addressing the output record to Q-track and impulsing TYPE on the control panel (see item 26). If both of these uses occur in the same program, the inquiry-type interlock must be jackplugged to prevent either of them from writing on the Q-track while the track is being used by the other.

30. *File Interlock*. This interlock is provided so that new programs may be tested without changing the information on the disks. When a program has been checked out, this switch is wired to allow the disk records to be changed. All operations except writing on the disks may be performed with the interlock off.

31. *ALC (Automatic Last Card)*. If the ALC switch is not plugged (when the cards have run out of the card reader hopper, and the last card has passed the second reading brushes), the card reader will stop. The operator may depress the reader start key, and feed the last cards to the stacker. Just after the operator depresses the start key, the last card selector transfers.

If the ALC switch is plugged, the card reader will feed cards for one additional cycle before stopping. During this additional cycle the last card selector transfers, and any last-card routines that have been programmed utilizing the last card selector can be completed. The cards may then be fed into the stacker by depressing the reader start key.

Printer Control Panel (Figure 99)

1. *Print Control Exits*. These hubs emit control impulses as the printer is positioned to print the corresponding positions of the print line. Each hub emits one impulse per line printed; for example, hub five emits an impulse every time print position five is being set up. These impulses are wired to initiate functions such as zero suppression, X-elimination, etc.

2. *Distributors*. Impulses that are used to initiate several functions are wired through distributors that serve the same function as split wires but prevent possible back circuits. An impulse wired into the IN hub of a distributor is available at the associated OUT hubs, but impulses cannot travel between OUT hubs, or from an OUT hub to the IN hub. Any impulse except that from the OUT hub of another distributor may be wired through a distributor.

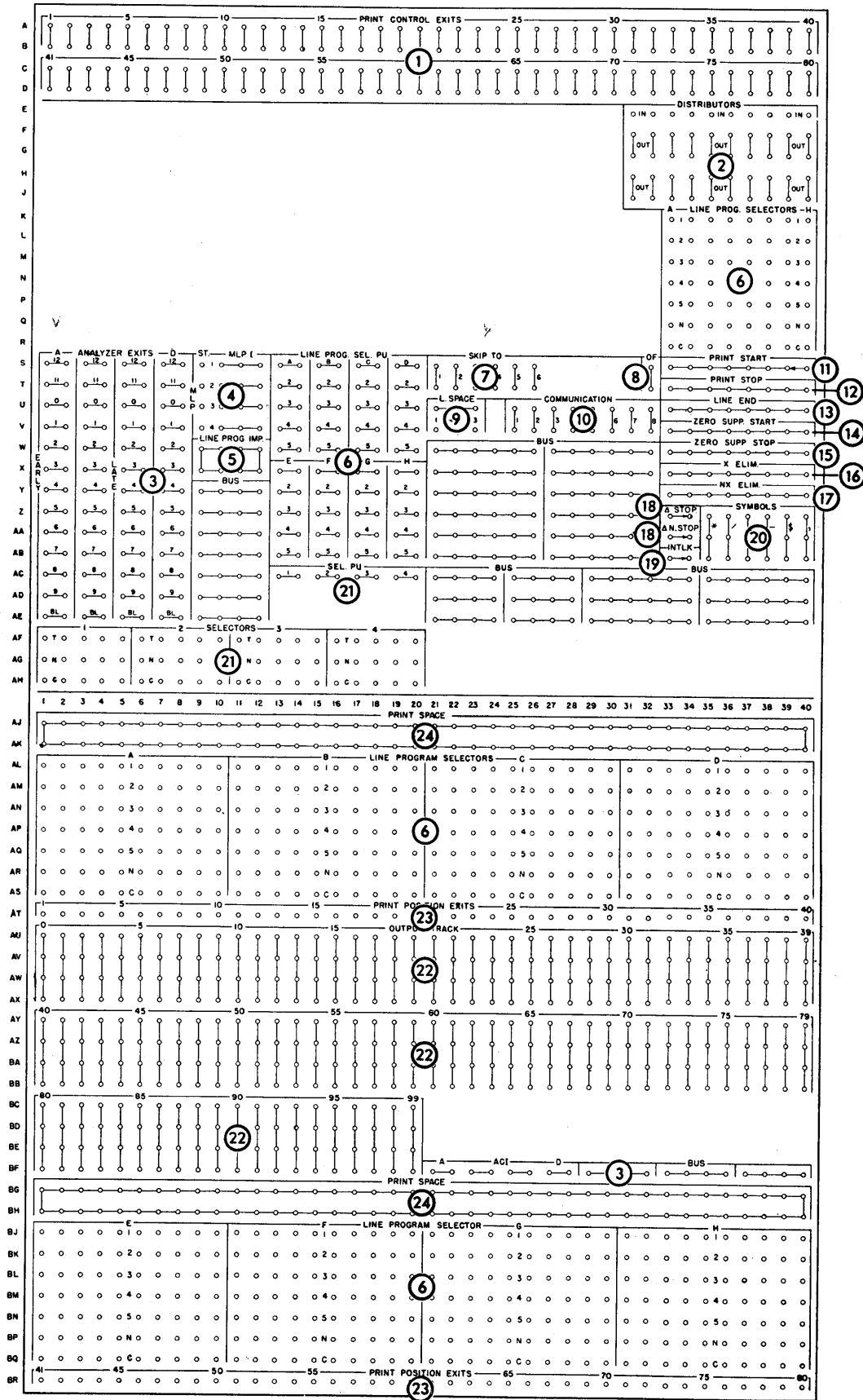

FIGURE 99. 370 PRINTER CONTROL PANEL

3. *Analyzers.* When a record has been transferred to the output track, and PRINT on the process control panel has been impulsed by a control code, the printer prepares to print a line. However, before the print mechanism moves from the home position, the output track may be analyzed.

By wiring from the ACI hubs of an analyzer to an output track position the digit or character that is present on the output track will condition the analyzer so that the ANALYZER EXITS will emit in IBM code. The 2 exit emits for a 2, the 12 and 1 exits emit for an A, etc.

4. *MLP (Multiple-Line Print).* The MLP unit controls the printing of multiple lines from a single output track. The START hub that corresponds to the number of lines desired is impulsed from an ANALYZER EXIT. The MLP I hubs emit an impulse at the beginning of the corresponding MLP line, in sequence 1, 2, 3, 4, up to the number of lines desired. These exit impulses are wired to pick up line program selectors to control the format on the corresponding print line.

5. *Line Program Impulse.* This impulse is available during the analysis portion of the print cycle. It is, however, inactive if MLP START has been previously impulsed. During an MLP operation, the MLP IMPULSE hubs emit, and the LINE PROGRAM IMPULSE hubs are inactive.

6. *Line Program Selectors.* The line program selectors are provided to allow format control of the information being printed from the output track. Each selector has eleven positions; ten of these are grouped near the output track and an eleventh position of each selector is near the control section. Each position has a COMMON hub, a NORMAL hub, and five TRANSFERRED hubs. The COMMON hub is connected to the NORMAL hub until one of the five pick-up hubs is impulsed, usually from the MLP I hubs. Then the COMMON hub is connected to the correspondingly numbered TRANSFERRED hub above it. The selectors remain transferred until the line is printed and drop out as the print head returns to the home position.

7. *Skip-To.* These hubs are impulsed from ANALYZER EXITS or from 305 control impulses wired through communication channels to cause the tractor to feed the paper in the printer to the corresponding hole in the control tape. In the carriage control tape, channels 1-6 stop the corresponding skips. Channel 12 in the control tape causes an impulse to be emitted from the OF (Overflow hub) that may be wired to advance the paper to the first printing line on the following form.

8. *OF (Overflow).* When a hole is sensed in the 12 channel of the carriage control tape, it causes an impulse to be emitted from these hubs. The impulse may be wired to cause the paper to be skipped to the first line of the following form by impulsing one of the SKIP-TO hubs, and placing a hole in the control tape in that channel to stop the tape at the proper place. The OF impulse may also be wired through communication channels to the processing control panel, where it may pick up a selector that is tested in the course of the program to determine if the overflow condition exists. Then steps in the program can decide whether

to complete the form or start the following form. If the printing is to overflow to the next form, the processing unit can, by control codes wired through communication channels, control the overflow skip.

9. *Line Space.* To allow variable spacing, the space control impulses are wired on the control panel. A jackplug may be inserted between one of the numbered hubs and the SPACE hub above it to cause single, double, or triple spacing. Alternatively, the space control wiring may be selected to allow variable spacing.

10. *Communication.* These hubs connect to the correspondingly numbered hubs on the 305 process control panel to allow signal communication between the processing unit and the printer.

11. *Print Start.* These hubs are impulsed from PRINT CONTROL EXITS to start printing at any desired column as the print head moves across the paper. Once the printing is started, the machine will continue to print until printing is turned off by impulsing PRINT STOP. In this way, printing can be turned on and off several times in the course of printing a line to give added flexibility in format control. The PRINT CONTROL EXIT for the first column of each field to be printed is wired to these hubs.

12. *Print Stop.* These hubs are impulsed from the PRINT CONTROL EXIT of the first position not to be printed, to turn printing off, when other information is to be printed later on the same line. Impulsing these hubs causes printing to be suppressed until PRINT START is impulsed.

13. *Line End.* These hubs are wired from the PRINT CONTROL EXIT of the position after the last position to be printed on a line to cause the printing to stop and the print head to return to the home position. This allows the length of the printing line to be controlled. Variable printing lengths are possible by wiring LINE END through selectors.

14. *Zero Suppression Start.* These hubs are wired from the PRINT CONTROL EXIT of the high-order position of a field to eliminate the printing of zeros to the left of significant digits. When these hubs have been impulsed, the print unit spaces over positions containing zeros until a significant digit (1-9) is encountered and printed; then all zeros to the right of the significant digit are printed.

15. *Zero Suppression Stop.* Once ZERO SUPPRESSION START has been impulsed, zero suppression will continue until a significant digit (not zero) is encountered and printed or until it is ended by impulsing these hubs from the PRINT CONTROL EXIT of the first position not to be suppressed.

16. *X-Eliminate.* Negative numbers are recorded on the output track (as on all other processing tracks) by an X-bit over the low-order position. For example, the amount 125 stands on the output track as 12N. The X-ELIMINATE and NX-ELIMINATE hubs allow the printer to read the X-punch or the digit punch from an output track position to separate the signed character into its sign and digit components. These hub are impulsed from PRINT CONTROL EXITS to cause only the digit portion of the character being set up to be printed.

17. *NX-Eliminate*. These hubs are impulsed from the PRINT CONTROL EXITS to allow only the sign portion of a character to be printed (item 16).

18. Δ (*Delta*). When the two hubs labeled Δ Stop are jackplugged, if a print setup error occurs, the machine will print a Δ in the left-hand margin opposite the line in error and the machine will stop.

When the two hubs labeled Δ N. Stop are jackplugged, the machine will print a Δ , but will not stop when a print setup error occurs.

If neither Δ STOP nor Δ N. STOP are plugged, the machine will stop, but a Δ will not be printed if a print setup error occurs.

19. *INTLK. (Interlock)*. These hubs must be jackplugged before any printing operation can be initiated. The printer will not operate if these hubs are left unplugged.

20. *Symbols*. These hubs are wired from the PRINT CONTROL EXITS to cause the corresponding symbol to be printed. These symbols may be selected through the line program selector.

21. *Selectors*. These selectors may be used to supplement the line program selectors. Each selector has five positions, and each position has a COMMON, a NORMAL and a TRANSFERRED hub. Normally, a connection exists between the COMMON and the NORMAL hub, but when the PICKUP hub is impulsed, this connection is broken and a connection is made between the COMMON and the TRANSFERRED hub in the same vertical column. The selectors may be picked up in the same manner as the LINE program selectors, and they remain transferred for the entire print line.

22. *Output Track*. At each printing position, the output track is read in its entirety, but only one character is selected for printing. This selection is made by wiring the hub corresponding to the output track position desired to the PRINT POSITION EXIT corresponding to the printing position where the character is to print.

23. *Print Position Exits*. These hubs are wired from the output track (item 22) to cause the corresponding positions to be set up to print information on the output track. For example, to print position ten of the output track in print position 50, OUTPUT TRACK ten is wired from PRINT POSITION EXIT 50.

24. *Print Space*. All print positions that are not wired from the output track should be wired to these hubs. This indicates to the checking circuits that the printer is not to print in the corresponding column, and allows the checking circuits to detect any position that was wired to print and failed to set up correctly.

Punch Control Panel (Figure 100)

1. *Output Track*. These hubs emit the IBM codes of the information on the output track. These exits may be wired to the punch magnets to cause punching. This allows any of the 100 output track positions to be punched into any of the 80 card columns.

2. *Digit Selector*. The DI hub at the top of the panel emits a series of impulses which are timed for punching the digits 12 through 9. If the DI hub is wired to the C hub beneath it, the digit selector becomes a digit emitter with a 12 impulse available at the 12 hub, and 11 impulse available at the 11 hub, etc. If an output track position is wired to the C hub, whatever digit or character appears at that output track position will be made available in IBM code at the numbered hubs of the digit selector.

3. *Sign Conversion*. Within the system, the 12 holes are coded by a combination of X- and 0-bits. Also, sign control on negative fields is maintained by carrying an X-bit over the low-order position. If the low-order position of a field is zero and the field is negative, a 12-hole would be punched if this position were wired directly to a punch magnet. The sign conversion hubs are provided so that the 12-impulse available from the output track may be converted to the X/0 code desired for these positions.

In use, the low-order position of any numerical field that may be negative is wired from the output track to an IN hub and from the corresponding OUT hub to the punch magnet. If a 12-code is emitted from this position of the output track, it is punched as X/0. Any other negative number is overpunched with an X. Positive numbers pass through without conversion.

4. *Column Splits*. This is a 10-position selector that is automatically controlled to transfer between X and 0 time as the card is punched. This allows the 12 and X zones to be removed from columns and punched into other columns.

5. *Punch Magnets*. These hubs are entries to the 80 punch magnets that punch the correspondingly numbered columns of the card. These magnets are wired from the output track positions that are to be punched.

6. *Punch Brushes*. On the punch cycle after it is punched a card passes a set of 80 reading brushes that read back the information that has been punched so that it may be given the double-punch blank-column check. These hubs are the exits for the reading on this cycle. The information may also be gangpunched back into the following card.

7. *DP & BC Det Entry*. These hubs may be wired from the punch brushes to check individual columns for double punching or lack of punching. This is particularly valuable in numerical fields, where every position must have one and only one hole. If the machine detects multiple punches or lack of a hole in any column wired, it will stop the machine if the control is wired to do so. The DPBC light on the punch unit is turned on to indicate the reason the machine stopped.

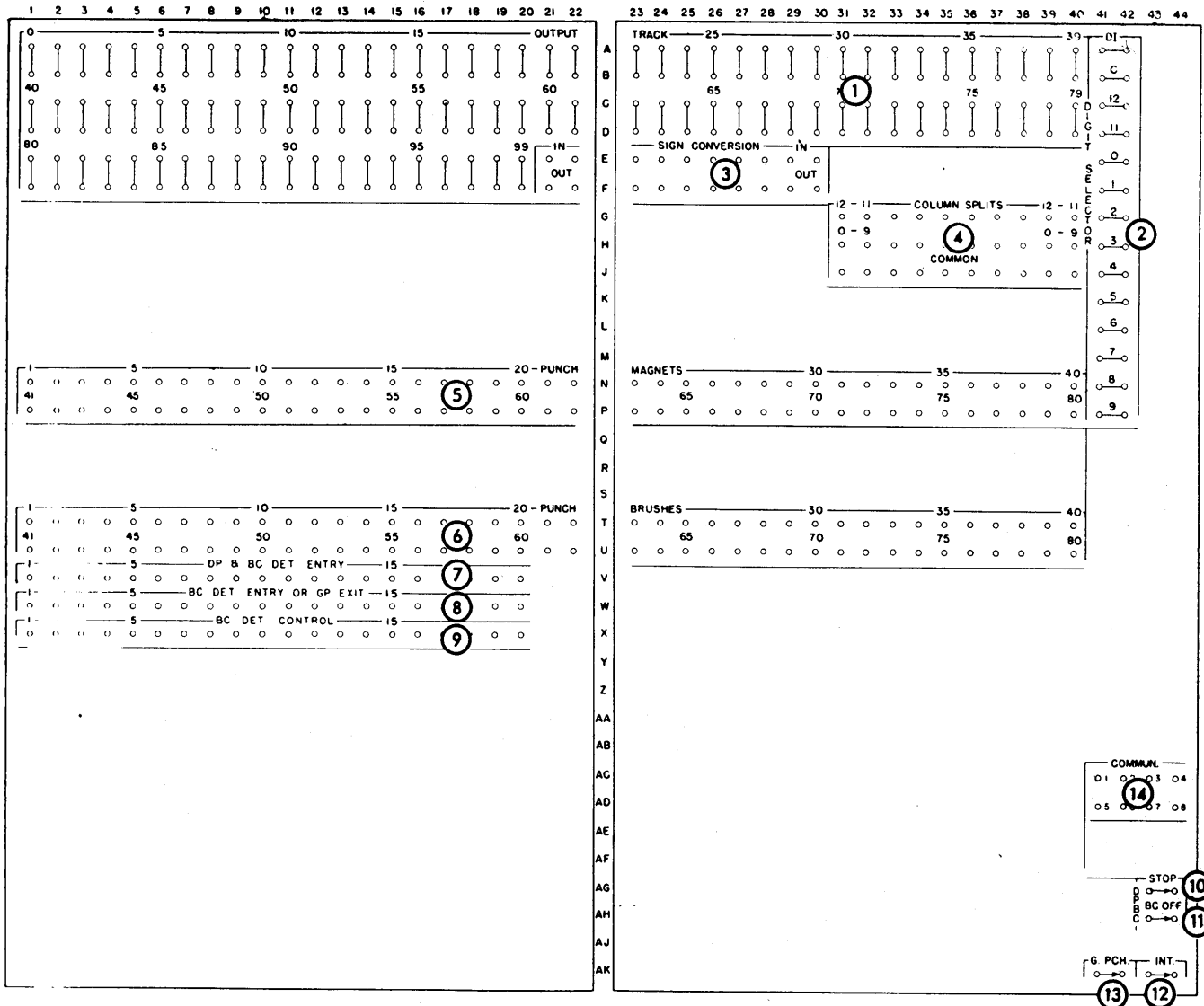

FIGURE 100. 323 PUNCH CONTROL PANEL

8. *BC Det Entry or GP Exit.* If the column being checked is wired into DP & BC DET ENTRY, the first impulse to enter the DP & BC DET ENTRY emerges from these hubs, from which it may be wired to a punch magnet for gang-punching.

If a column in which double punching is permissible is to be checked for blanks, these hubs are used as an entry. The first impulse to enter these hubs emerges from the DP & BC DET ENTRY hubs.

9. *BC Det Control.* If no checking for blank columns is to be done, the BLANK COLUMN OFF switch (item 11) must be wired. To check a field for blank columns, wire the field to the ENTRY or EXIT of the DP & BC. If any one field is to be checked, wire it to the left-hand entry positions and, in the blank-column detection control row, wire from the right-hand column of the field to the last position in the row. Several fields can be entered as one field for checking purposes.

10. *DPBC Stop.* When these hubs are jackplugged, the machine will stop if a DPBC error occurs. This switch may be selected if co-selectors are used.

11. *BC Off (Blank Column Off).* These hubs must be jackplugged to turn the blank column detection feature off when no punched columns are to be checked for blank columns.

12. *INT. (Interlock).* Whenever the punch is to be used to punch output cards for the processing unit, this control-panel switch must be jackplugged.

13. *Gangpunch.* When this control-panel switch is jackplugged, the 323 punch is removed from the control of the processing unit and may be used as an independent gang-punch.

14. *Communication.* These hubs are connected to the correspondingly numbered hubs labeled *Punch Communication* on the process control panel.

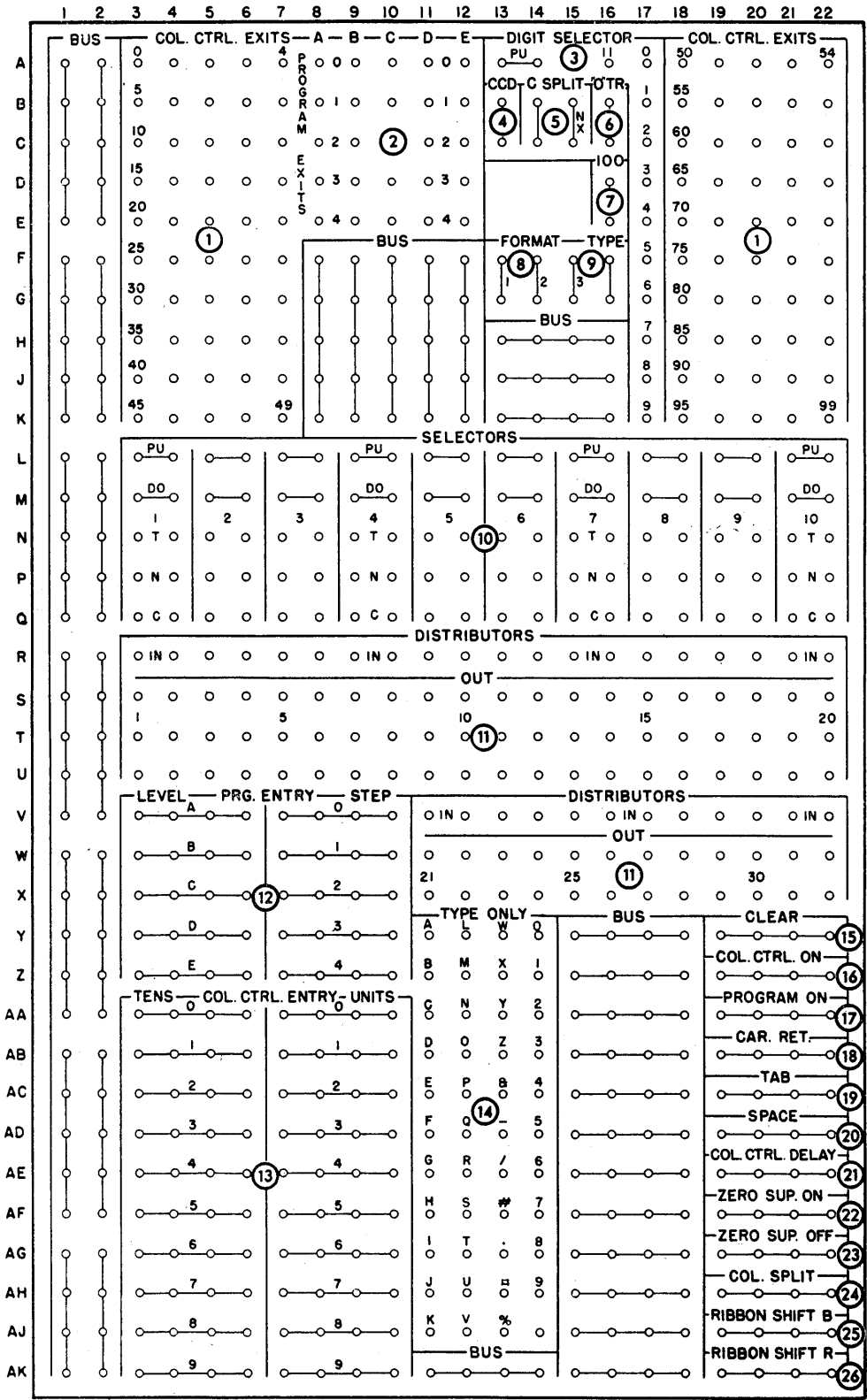

FIGURE 101. 380 TYPEWRITER CONTROL PANEL

Typewriter Control Panel (Figure 101)

1. *Column Control Exits.* When the typewriter is being used for inquiries or for printing an auxiliary document, these hubs sequentially emit impulses that coincide with the reading of the corresponding position of the typewriter Q-track. These impulses control the format of the information being printed.

The first Q-track position to be read is controlled by wiring the COLUMN CONTROL ENTRY (item 13). Subsequently, the machine reads succeeding positions until the control is transferred elsewhere. This arrangement allows the typewriter to type fields from the typewriter track in any order.

If at any time the program unit or the column control delay are turned on, the COLUMN CONTROL EXITS stop emitting, but the same sequential position is held, unless the COLUMN CONTROL ENTRY is impulsed to transfer control to another position. When the PROGRAM ON hubs are impulsed, column control is turned off until COLUMN CONTROL ON is impulsed. When COLUMN CONTROL DELAY is impulsed, on the following cycle an impulse is emitted from the CCD hub, and then column control is turned on again automatically.

2. *Program Exits.* When PROGRAM ON is impulsed, these hubs sequentially emit impulses when the typewriter is being used for inquiries or for printing an auxiliary document. These impulses are used for typewriter control and to type constants, legends and special characters not on the typewriter track. Until the program is turned off by impulsing COLUMN CONTROL ON, the program advances through steps 0-4 in levels A-E. When the program is first turned on after the final dropout of the previous operation, PROGRAM EXIT A0 will emit, followed by A1, A2, A3, A4, B0, B1, B2, etc. The program impulses may be started at another point by impulsing PROGRAM ENTRIES (item 12).

3. *Digit Selector.* It is sometimes desirable to know the contents of a certain typewriter track position so that format control may be altered on the basis of the character coding. When the PU hub is impulsed from a COLUMN CONTROL EXIT, the character in that position is analyzed and emitted in IBM code from the hubs labelled 12-9. While this is taking place, the printing of the character is suppressed.

4. *CCD (Column Control Delay).* Whenever COLUMN CONTROL DELAY is impulsed, the CCD hubs emit an impulse that may be used for spacing or other functions. Column control is suspended for the cycle on which these hubs emit. After one cycle, the column control resumes from the step after the one on which the control was impulsed (item 21).

5. *Column Split (X-NX).* When COLUMN SPLIT is impulsed, on the next cycle column control is suspended and either the X- or NX-hub will emit. The X-hub emits if the character being analyzed by the column split device contained an X-bit. If no X-bit was present, the NX-hub emits (item 24).

6. *0 TR (Zero Transfer).* Whenever the zero transfer feature is turned on by impulsing ZERO SUP ON (item 22) (if a zero is read from the typewriter track) it is not printed, but an impulse is emitted from these hubs. This impulse may be wired to SPACE (item 20) to maintain vertical column alignment.

7. *100 (Type 100).* Impulsing these hubs causes all 100 characters to be typed from the typewriter track, in position sequence, without format control.

8. *Format.* These hubs emit control impulses when the corresponding format key is depressed on the keyboard. The impulses from these hubs may be used to set selectors to establish format control for three different types of inquiries and to start the typewriter control panel program.

9. *Type.* When the TYPE hubs are impulsed on the process control panel, they emit an impulse that may be used to control format for lines typed out under stored program control and to start the typewriter control panel program.

10. *Selectors.* Ten 2-position selectors are provided to facilitate format control. Normally a connection exists between each c hub and the n hub above it. When an impulse is wired to the pu hub this connection is broken and the c hub is connected to the r hub above it. This connection remains until the do (dropout) hub is impulsed.

11. *Distributors.* Impulses that are used to initiate several functions are wired through distributors that serve the same function as split wires but prevent possible back circuits. An impulse wired into the in hub of a distributor is available at the associated out hubs, but impulses cannot travel between out hubs, or from an out hub to the in hub. Any impulse except that from the out hub of another distributor may be wired through a distributor.

12. *Program Entry (Also item 2).* To establish the beginning of a sequence of program impulses, one LEVEL hub and one STEP hub are impulsed in the same manner that the PROGRAM ENTRIES are impulsed on the process control panel. The program unit is turned on automatically by impulsing PROGRAM ENTRY without impulsing program on.

13. *Column Control Entry.* To establish the beginning of a sequence of column control (item 1), one TENS and one UNITS hub are impulsed in the same manner that the PROGRAM ENTRIES are impulsed on the process control panel. Column control is turned on automatically by impulsing COLUMN CONTROL ENTRY without impulsing COLUMN CONTROL ON.

14. *Type Only.* When these hubs are impulsed from program exits or CCD, the corresponding characters are typed.

15. *Clear.* Impulsing these hubs causes the typing to stop and the carriage to return.

16. *Column Control On.* These hubs are impulsed to restore the typewriter to column control after program control has been used, if it is desired to restart from the track position after the last position used previously. Column control is turned on automatically if a column control entry is made. Program control is turned off.

17. *Program On.* These hubs are impulsed to place the typewriter under program control. Column control is turned off. Program control is turned on automatically when a program entry is made.

18. *Carriage Return.* Impulsing these hubs causes the typewriter carriage to return to the home position.

19. *Tabulate*. Impulsing these hubs causes the carriage to tabulate to the next tab stop.

20. *Space*. Impulsing these hubs causes the typewriter to space one space.

21. *Column Control Delay (Item 4)*. When these hubs are impulsed, column control or program control (whichever is in effect) is suspended for one cycle, during which an impulse is emitted from the CCD hub (item 4). Column control or program control resumes control immediately after this cycle, continuing from the step after the step that was wired to impulse the delay.

22. *Zero Suppression On (Also item 6)*. When this hub is impulsed, if a zero is read from the typewriter track it will not be typed, but an impulse will be emitted from the 0 TR hubs (item 6) which may be wired to cause spacing or some other function. The printing of zeros is resumed when the OFF hub is impulsed (item 23) or when a character other than zero is read from the track. This arrange-

ment allows the zeros in the high-order position of fields to be suppressed.

23. *Zero Suppression Off*. These hubs are impulsed to turn the zero suppression feature off when it is desired to print zeros to the left of significant digits, and the feature has been turned on by previous wiring.

24. *Column Split*. Impulsing these hubs causes the column split device to analyze the character being typed for the presence or absence of an X-bit. On the next cycle, column control is automatically suspended and the COLUMN SPLIT X- or NX-hub will emit. When COLUMN SPLIT is impulsed from a COLUMN CONTROL EXIT, the corresponding Q-track character will type only as a numeric digit.

25. *Ribbon Shift Black*. Impulsing this hub causes the typewriter to type through the black portion of a two-color ribbon.

26. *Ribbon Shift Red*. Impulsing this hub causes the typewriter to type through the red portion of a two-color ribbon.

CODING

Stored Program Coding

The stored program codes are repeated here for reference:

	FROM	TO
Processing Storage Tracks	W	W
	X	X
	Y	Y
	Z	Z
Program and General Storage Tracks	0	0
	1	1
	2	2
	3	3
	4	4
	5	5
	6	6
	7	7
	8	8
	9	9
	&	&
	A	A
	B	B
	C	C
	D	D
	E	E
F	F	
G	G	
H	H	
I	I	
Accumulator		
Add		L
Subtract		M
Read out and reset	M	
Read out	L	
Multiplicand	V	V
Multiplier		N
Input Track	K	K
Output Track	S	S
Disk Memory	R	R
Address Register		J
Character Selector		-(hyphen)
Inquiry Track	Q	Q
Magnetic Core Unit	-(hyphen)	

Control Operation Codes

These codes, in the ninth position of the instruction, cause the program to be brought to the control panel on the corresponding hubs.

A-Z, 0-9, . □ & \$ * - / , % # @ (47 characters)

Comparison Control

These codes, in the tenth position of the instruction, operate as follows:

1. Compare the information in the TO and FROM locations — 1 to 100 columns.
2. Field compare from one to ten 10-position fields of a track specified by the FROM address with the fields of a track specified by the TO address.
3. Combined compare causes both the regular compare and field compare devices to compare information.
5. Cause an accumulator to reset and then add or subtract.

Approximate Operating Times

NOTE: All operating times included in this manual are approximate at the time of publication, and are subject to change. They are included to assist in programming.

Seek Access Time. Figure 102 shows graphically the access time when the arm is moved between tracks on the same disk. For example, if the arm is moved from track 05 to track 55, a distance of 50 tracks, the access time will be from 200-250 milliseconds.

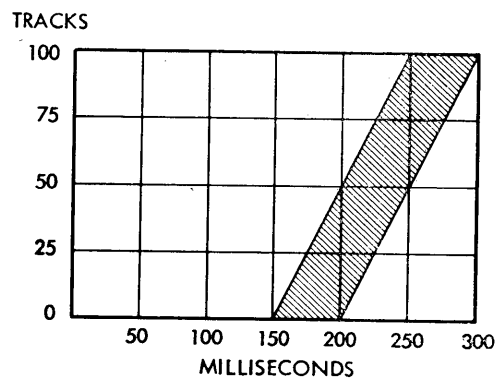

FIGURE 102. SEEK TIME FOR ACCESS ARM MOVING FROM TRACK TO TRACK ON SAME DISK

Figure 103 shows the access time when the arm is moved from one disk to another disk. For example, if the arm is moved from disk 15 to disk 40, a distance of 25 disks, the access time will be from 550-650 milliseconds. These timings are approximate and tentative.

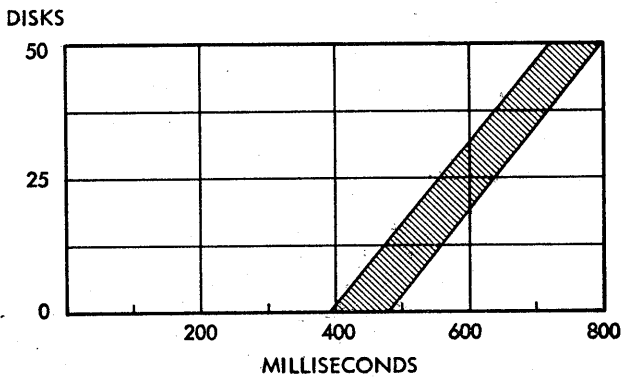

FIGURE 103. SEEK TIME FOR ACCESS ARM MOVING FROM TRACK ON ONE DISK TO TRACK ON ANOTHER DISK

Card Feed Input (125 cpm maximum) 480 ms/card
 Printer Output
 80 positions (30 lpm) 2000 ms/line
 60 positions (38 lpm) 1580 ms/line
 40 positions (54.5 lpm) 1100 ms/line
 20 positions (80 lpm) 750 ms/line
 Punch Output (100 cpm max.) 600 ms/card

Processing Control Unit
 Transfer between drum tracks 30 ms/step
 Transfer disk to drum track:
 80 ms max., 55 ms avg., 30 ms min.
 Transfer drum to disk:
 130 ms max., 105 ms avg., 80 ms min.

Complete Machine Schematic

Figure 104 summarizes the control codes on a schematic diagram of the system.

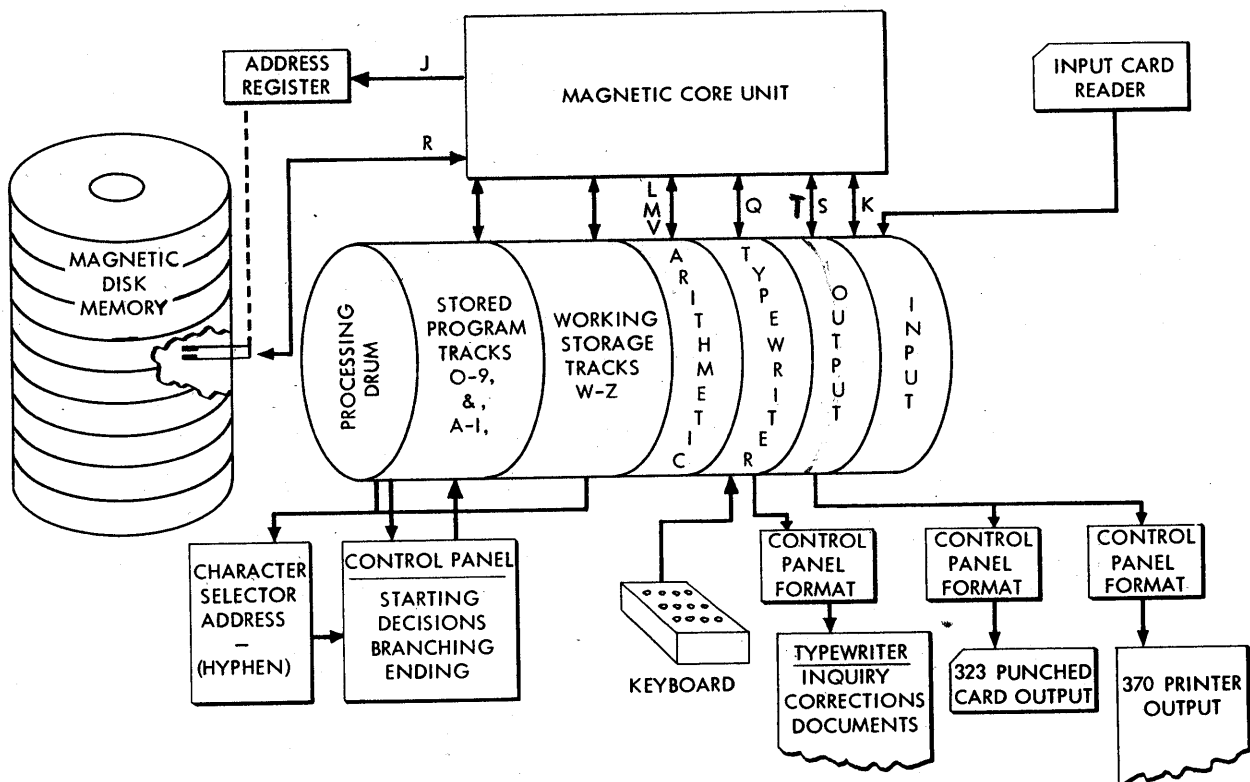

FIGURE 104. ADDRESS SUMMARY OF THE 305 SYSTEM

INDEX

Accumulator Lights (380)	80	DC Off Key (380)	74
Accumulator Overflow Light (380)	80	DC On (380 Light)	78
Accumulator Overflow Selectors	34	Delta (370)	111
Accumulators	37	Digit Selector (323)	133
Accumulator Sign Selectors	39	Digit Selector (380)	96
ACI Hubs (370)	108	DI Hubs (323)	132
Address Register	27	Disk Storage	12
Advantages (RAMAC Approach)	8	Disk Storage Loading	33
ALC Hubs	48	Disk Storage Organization	61
Alterations to Drum Tracks (Console)	87	Disk Storage Unloading	36
Alter Key (Keyboard)	83	Distributors (305)	20
Alteration Switches (380)	76	Distributors (370)	110
Alteration Switch Selectors	48	Distributors (380)	91
Analyzer Control Impulse Hubs (380)	108	Double Punch and Blank Column Detection	130
Analyzer Exit Hubs (370)	108	DP & BC Det Entry Hubs (323)	131
Analyzers (370)	108	DP and BC Light (323)	128
Approximate Operating Times	147	DPBC Stop Hubs (323)	131
Arithmetic Operations	37	Drum	16
Automatic Last Card Hubs	48	Dup Key (Keyboard)	84
Availability Editing	40		
		Error Correction (Console)	85
BC Det Control Hubs (323)	131	Error Correction Procedures (323)	133
BC Det Entry or GP Exit Hubs (323)	131	Examples of Console Operation	85
BC OFF Hubs (323)	130		
Blank Transmission Light	80	Feed and Punch Unit	127
Blank Transmission Selectors	47	Feed Card	22
		Feed Check	71
Card Punch	12	Feed Check (380)	79
Card Reader	11	Feed Check Light (323)	128
Carriage	11, 113	Field Compare	29
Carriage Return Hubs (380)	92	Field Compare Hubs	30
CCD Hubs (380)	92	Field Compare Lights (380)	80
Character Coding System	70	File Check Light (380)	82
Character Keys (Keyboard)	84	File Error Check	73
Character Selector	47	File Interlock Hubs	33
Character Selector Lights (380)	80	File Loading	33
Check Light (370)	104	File Unloading	36
Check Reset Key (323)	127	Format Hubs (380)	90
Check Reset Key (370)	104	Format Keys (Keyboard)	83
Check Reset Key (380)	76	Form Control (370)	117
Clear Hubs (380)	91	Form Inserting (370)	116
Clear Key (Keyboard)	84	Form Light (370)	104
Clock	73	Form Sizes (370)	115
Clock Light (380)	82	Forms Tractor Clutch	116
Coding	147	Form Thickness Adjustment Device (370)	116
Column Control Delay Hubs (380)	92		
Column Control Entry Hubs (380)	90	Gangpunch Hubs (323)	132
Column Control Exit Hubs (380)	90		
Column Control On Hubs (380)	92	Half Adjustment	44
Column Split Hubs (323)	130		
Column Split Hubs (380)	95	Index Record	65
Column Split X-NX Hubs (380)	95	Indicative Information	119
Combined Compare	31	Indicator Lights (380)	78
Communication Hubs (305)	49	In-Line Processing	5
Communication Hubs (323)	132	Input Track	20
Communication Hubs (370)	111	Inquire Hubs	48
Compare Hubs	29	Inquiries (Console)	85
Compare Light (380)	80	Inquiry Light (380)	82
Comparing	28	Inquiry-Type Interlock Hubs	48
Complete Machine Schematic	148	Inserting a New Form (370)	116
Console	13, 74	Inserting the Tape	114
Console Operation Examples	85	Instruction Lights (380)	79
Constants and Legends	17	Interlock Hubs (323)	132
Control Buttons (380)	77	Interlock Hubs (370)	111
Control Codes	19	Interlock Light (380)	82
Control Impulse (380)	77	Internal Checking	70
Control Impulse Hubs	48	ITI Hubs	48
Control Keys (380)	74		
Control Panel (Process)	14	Keyboard Functions	83
Control Panel Summary	137	Keys and Lights (323)	104
Control Panel Summary (305)	137	Keys and Lights (370)	127
Control Panel Summary (323)	142		
Control Panel Summary (380)	145	Last Card Selectors	49
Control Panel Summary (370)	139	LC Light (380)	80
Control Selector Switch (380)	76	Line End Hubs (370)	110
Control Stop Light (380)	82	Line Program Impulse Hubs (370)	123
Control Switches (380)	76	Line Program Selectors (370)	108
Control Tape	113	Line Space Hubs (370)	120
Copy Hubs	24	Loading the Disk Storage	33
Core Unit	18	Loading the Program	24
CR (Keyboard)	84	Locating the Record During Processing	68
Cycle Delay Hubs	48		
Cycle Lights (380)	80		
Cycle (Print)	104		

INDEX (continued)

Machine Components	10	Reader Start Key (380)	75
Machine Schematic	148	Reader Stop Key (380)	74
Magnetic Core Unit	18	Read Key (Keyboard)	83
Magnetic Disk Storage	12	Ready Light (323)	127
Magnetic Disk Storage (Programming)	27	Ready Light (370)	104
Main Line Power Switch (323)	127	Record Advance Hubs	28
Main Line Power Switch (370)	104	Record Layout	17
Master Power-Off	74	Record Skip	31
MLP Hubs (370)	121	Reset Key (370)	74
Multiple Line Printing	121	Reset Key (380)	104
Multiplication	43	Reset Light (380)	82
Non-Process Runout Key (380)	75	Reset Stop Hubs	34
NX-Eliminate Hubs (370)	111	Restore Key (Carriage)	116
OF Hubs (370)	117	Ribbon Shift Black Hubs (380)	96
100 (Type 100) (380)	95	Ribbon Shift Red Hubs (380)	96
Operating Features (Carriage)	116	Sample Program	50
Operating Keys and Lights (323)	104	Schematic of the Complete Machine	148
Operating Keys and Lights (370)	127	Select Lights (380)	82
Operating Speeds	10	Selector Lights (380)	80
Operating Times (Approximate)	147	Selectors (305)	47
Other Logic Elements	47	Selectors (370)	108
Output Printer	11	Selectors (380)	91
Output Track	22	Sign Conversion Hubs (323)	128
Output Track Hubs (323)	105	Skip-to Hubs (370)	117
Output Track Hubs (370)	128	Skip-to Record Hubs	31
Overflow Indicative Information	119	Space Bar (Keyboard)	84
Parity Check	72	Space Hubs (380)	92
Parity Light (323)	82	Speeds of Operations (Approximate)	147
Parity Light (380)	128	Start Hub	24
Power Off (380)	74	Start Key (323)	104
Power On (380 Light)	78	Start Key (370)	127
Power-On Key (380)	74	Start-Stop Procedures (Console)	85
Power-On Light (323)	104	Stick Printing	102
Power-On Light (370)	128	Stop Hubs	34
Print Check	73	Stop Key (Carriage)	116
Print Control Exit Hubs (370)	109	Stop Key (323)	127
Print Control Functional Hubs	110	Stop Key (370)	104
Printer	11, 102	Stop Light (380)	78
Print Cycle	104	Stored Program	15
Print Hubs	22	Symbols Hubs (370)	111
Printing Overflow Indicative Information	119	System Organization	10
Print Position Exit Hubs (370)	105	Tabulate Hubs (380)	92
Print Space Hubs (370)	105	Tape (Control)	113
Print Start Hubs (370)	110	Tape-Controlled Carriage	11, 113
Print Stop Hubs (370)	110	Tape Inserting	114
Process Control Panel	14, 15	Tape Punching	115
Processing Drum	16	Test Light (380)	82
Processing Unit	10	Test Lock	78
Program Advance	20	Testing a Program (Console)	88
Program Entries	20	Testing Procedures (Console)	88
Program Entry Hubs (380)	91	323 Card Punch	126
Program Exits	19	323 Control Panel	128
Program Exit Hubs (380)	91	323 Punch Check	73
Program Load (380)	77	370 Printer	102
Program Loading	24	370 Printer Control Panel	105, 106
Programmed Addressing	62	370 Printer Output Check	73
Programmed Division	45	370 Printer Timing Chart	124
Programming	15	380 Console	74
Program-On Hubs (380)	92	380 Console Typewriter	89
Program Selector Switches (380)	77	305 RAMAC Approach (Inventory, Billing, and A/R Application)	8
Program Set Key (380)	76	Time Required (Sample Program)	59
Program Start Key (380)	76	Timing Chart (370)	124
Program Step Indicators (380)	79	To Insert a New Form (370)	116
Program Stop Key (380)	76	Type Hubs	23
Program Testing (Console)	88	Type Hubs (380)	90
Punch Brush Hubs (323)	128	Type 100 (380)	95
Punch Check	73	Type Only Entry (380)	96
Punched Card Approach (Inventory, Billing, and A/R Application)	6	Typewriter Control Panel	89, 90
Punch Hubs	22	Typewriter Column Lights (380)	80
Punching the Tape	115	Typewriter Output	22
Punch-Magnet Hubs (323)	128	Unequal Compare Light (380)	80
Punch Unit	12	Unloading the Disk Storage	36
RAMAC	4	Write Key (Keyboard)	83
RAMAC Approach (Inventory, Billing and A/R Application)	8	X-Eliminate Hubs (370)	110
Random Access Method of Accounting and Control	5	Zero Suppression Off Hubs (380)	95
Randomizing	62	Zero Suppression On Hubs (380)	95
Read Check	71, 79	Zero Suppression Start Hubs (370)	110
Reader	11	Zero Suppression Stop Hubs (370)	110
Reader Power (380)	78	Zero Transfer (0Tr) Hubs (380)	95
Reader Ready (380)	78		

IBM®

IBM 305 RAMAC

Form 22-6264-1